



2004 Wiring Diagrams

Buy Now



DEMO

This DEMO contains only a few pages of the entire manual/product.

Not all Bookmarks work on the Demo, but they do on the full version.

Features:

- Searchable text
- Printable pages
- Bookmarked for easy navigation
- High Resolution images
- Zoom to see exact details
- Money back Guarantee
- Available on USB and eBook download

F-150



License #84356800



Copyright © 2024, Forel Publishing Company, LLC, Woodbridge, Virginia

All Rights Reserved. No part of this book may be used or reproduced in any manner whatsoever without written permission of Forel Publishing Company, LLC. For information write to Forel Publishing Company, LLC, Woodbridge, VA 22192

2004 Ford F-150 Truck Wiring Diagrams

EAN: 978-1-60371-492-1

ISBN: 1-60371-492-8

Forel Publishing Company, LLC
Woodbridge, VA 22192
Email: sales@ForelPublishing.com
<https://www.ForelPublishing.com>



License #84356800

This publication contains material that is reproduced and distributed under a license from Ford Motor Company. No further reproduction or distribution of the Ford Motor Company material is allowed without the express written permission of Ford Motor Company.

Note from the Publisher

This product was created from the original Ford Motor Company's publication. Every effort has been made to use the original scanned images, however, due to the condition of the material; some pages have been modified to remove imperfections.

Disclaimer

Although every effort was made to ensure the accuracy of this book, no representations or warranties of any kind are made concerning the accuracy, completeness or suitability of the information, either expressed or implied. As a result, the information contained within this book should be used as general information only. The author and Forel Publishing Company, LLC shall have neither liability nor responsibility to any person or entity with respect to any loss or damage caused, or alleged to be caused, directly or indirectly by the information contained in this book. Further, the publisher and author are not engaged in rendering legal or other professional services. If legal, mechanical, electrical, or other expert assistance is required, the services of a competent professional should be sought.



F-150 Wiring Diagrams

Table of Contents	1-1	Fog Lamps	86-1
Index	2-1	Autolamps	87-1
Introduction	3-1	Courtesy Lamps	89-1
Symbols	4-1	Turn/Stop/Hazard Lamps	90-1
Connector Repair Procedures	5-1	Exterior Lamps	92-1
Wiring Harness Overview	9-1	Reversing Lamps	93-1
Grounds	10-1	Trailer/Camper Adapter	95-1
Fuse and Relay Information	11-1	Daytime Running Lamps	97-1
Charging System	12-1	Power Windows	100-1
Power Distribution	13-1	Roof Opening Panel	101-1
Module Communications Network	14-1	Power Door Locks	110-1
Starting System	20-1	Anti-Theft	112-1
Engine Ignition	21-1	Remote Control Alarm and Locks	117-1
Engine Controls – 4.6L	23-1	Climate Controlled Seats	119-1
Engine Controls – 5.4L	24-1	Power Seats	120-1
Transmission Controls – 4R70E/4R75E	29-1	Memory Seats	123-1
Vehicle Speed Control	31-1	Power Mirrors	124-1
Electronic Shift Control	34-1	Electronic Day/Night Mirror	125-1
Shift Lock	37-1	Adjustable Pedal	127-1
ABS	42-1	Radio	130-1
Horn/Cigar Lighter	44-1	Parking Aid	131-1
Air Bags	46-1	Rear Seat Entertainment (RSE)	132-1
Air Conditioner/Heater	54-1	Component Testing	149-1
EATC	55-1	Connector Views	150-1
Rear Window Defrost	56-1	Component Location Views	151-1
Instrument Cluster	60-1	Component Location Charts	152-1
Illumination	71-1	Vehicle Repair Location Charts	160-1
Wipers and Washers	81-1		
Headlamps	85-1		

NOTE: The descriptions and specifications contained in this manual were in effect at the time this manual was approved for printing. Ford Motor Company reserves the right to discontinue models at any time, or changes specifications or design without notice and without incurring any obligation.

PUBLICATIONS ORDERING INFORMATION

To obtain information about ordering additional copies of this publication or to order any other Ford or Lincoln/Mercury publications, call 1-800-782-4356. Available publications include Workshop Manuals, Wiring Diagrams, PC/ED Manuals and Owner Guides.

For more information, write to: Ford Publications, care of Helm Inc., P.O. Box 07150, Detroit, MI 48207.

Electronic or mechanical, including photocopying, recording, or by any information storage and retrieval system or translation in whole or part is not permitted without written authorization from



100% SATISFACTION GUARANTEED

BUY IT NOW!

Click Here To Order

4R70E/4R75E Transmission	29-3	Camshaft position sensor 1 (6B288) – 5.4L	24-4
4x4 center axle disconnect solenoid	34-2	Camshaft position sensor 2 (6B288) – 5.4L	24-4
4x4 High/Low indicator switch (7E440)	34-1	Central Junction Box (CJB) (14A067)	13-1
A/C clutch cycling pressure switch (19E561)	54-3	Charge Motion Control Valve (CMCV) – 5.4L	24-4
A/C clutch cycling pressure switch (19E561) – EATC	55-4	Cigar lighter, front (15055)	44-2
A/C clutch relay	54-3	Clockwise (CW) motor 4x4 relay	34-2
A/C clutch relay – EATC	55-4	Coil On Plug (COP) 1 (12A366)	21-2
A/C clutch solenoid (19D798)	54-3	Coil On Plug (COP) 2 (12A366)	21-2
A/C clutch solenoid (19D798) – EATC	55-4	Coil On Plug (COP) 3 (12A366)	21-2
A/C Compressor clutch diode	54-3	Coil On Plug (COP) 4 (12A366)	21-2
A/C Compressor clutch diode – EATC	55-4	Coil On Plug (COP) 5 (12A366)	21-2
A/C high pressure switch (19D594)	54-3	Coil On Plug (COP) 6 (12A366)	21-2
A/C high pressure switch (19D594) – EATC	55-4	Coil On Plug (COP) 7 (12A366)	21-2
ABS control module (0273004685)	42-1	Coil On Plug (COP) 8 (12A366)	21-2
Accessory delay relay	13-9	Counterclockwise (CCW) motor 4x4 relay	34-2
Adjustable pedal memory potentiometer – with memory	127-2	Crankshaft position sensor (6C315)	21-1
Adjustable pedal motor (2C429) – with memory	127-2	Cylinder-head temperature sensor (6G004) – 4.6L	23-4
Adjustable pedal motor (2C429) – without memory	127-1	Cylinder-head temperature sensor (6G004) – 5.4L	24-4
Adjustable pedal switch – without memory	127-1	Data Link Connector (DLC) (14489)	14-1
Air bag sliding contact (14A664)	31-2	Daytime Running Lamps (DRL) enable relay	97-2
Air bag sliding contact (14A664)	46-2	Daytime Running Lamps (DRL) relay	97-2
Ambient air temperature sensor (19E702)	60-2	Daytime running lamps resistor (14A65)	97-2
Antenna	130-1	Deactivator switch (9C872)	31-1
Audio/climate control switch (14K147)	130-6	Digital Transmission Range (DTR) sensor (7F293)	29-2
Audio/climate control switch (14K147) – EATC	55-1	Door ajar switch, driver side rear (14018)	117-3
Audio unit (18C869)	130-1	Door ajar switch, left front	117-3
Autolamp/sunload sensor (14A597)	55-3	Door ajar switch, passenger side rear (14018)	117-3
Auxiliary relay box 1	13-3	Door ajar switch, right front	117-3
Battery (10655)	13-1	Door lock actuator, left front	110-2
Battery saver relay	89-1	Door lock actuator, left rear (218A43)	110-2
Blower motor resistor (19A706)	54-1	Door lock actuator, right front	110-2
Body control module (15K602)	117-1	Door lock actuator, right rear (218A42)	110-2
Brake level switch (2L414)	60-2	Door lock switch, driver side (14028)	110-1
Brake pedal switch (2L414)	31-1	Door lock switch, passenger side (14017)	110-1
Brake pressure switch (19E561)	37-1	Driver air bag (54043B13)	46-2
Brake pressure switch (19E561) – EATC	23-4	Driver memory seat front height sensor	123-2

100% SATISFACTION GUARANTEED

BUY IT NOW!

Click Here To Order

PayPal Discover MasterCard VISA

Driver memory seat horizontal sensor	123-2	F2.15	13-15
Driver memory seat rear height sensor	123-2	F2.16	13-13
Driver seat module (14C708)	123-1	F2.17	13-6
DVD player (10E947)	132-2	F2.18	13-14
EGR system module - 4.6L	23-4	F2.19	13-15
Electrochromatic inside mirror unit (17A674)	125-1	F2.20	13-3
Electronic Automatic Temperature Control (EATC) module (19980)	55-1	F2.21	13-9
Electronic compass (19A548)	125-2	F2.22	13-9
Electronic Manual Temperature Control (EMTC) module (19980)	54-1	F2.23	13-20
Electronic Throttle Control (ETC) module (9F836) - 4.6L	23-6	F2.24	13-10
Electronic Throttle Control (ETC) module (9F836) - 5.4L	24-6	F2.25	13-20
Electronic Throttle Control (ETC) motor (9F991) - 4.6L	23-6	F2.26	13-10
Electronic Throttle Control (ETC) motor (9F991) - 5.4L	24-6	F2.27	13-15
Engine Oil Temperature (EOT) sensor (6C624) - 5.4L	24-4	F2.28	13-15
EVAP canister vent control solenoid (9B593) - 4.6L	23-3	F2.29	13-3
EVAP canister vent control solenoid (9B593) - 5.4L	24-3	F2.31	13-11
Evaporative emission (EVAP) canister vent valve (9F945) - 4.6L	23-3	F2.32	13-6
Evaporative emission (EVAP) canister vent valve (9F945) - 5.4L	24-3	F2.33	13-6
Exterior rear view mirror, driver side (17682)	124-1	F2.34	13-6
Exterior rear view mirror, passenger side (17683)	124-1	F2.35	13-6
Exterior rear view mirror switch (17B676)	124-1	F2.36	13-21
F1.01	71-2	F2.37	13-11
F2.01	13-13	F2.38	13-11
F2.02	13-1	F2.39	13-11
F2.03	13-2	F2.40	13-11
F2.04	13-2	F2.41	13-12
F2.05	13-2	F2.42	13-21
F2.06	13-3	F2.101	13-12
F2.07	13-13	F2.102	13-12
F2.08	13-5	F2.103	13-16
10	13-4	F2.105	13-16
	13-3	F2.106	13-4
	13-13	F2.107	13-16
	13-14	F2.108	13-16
		F2.109	13-17
		F2.111	13-17

F2.112	13-16	Fuel injector 8 (9F593) – 5.4L	24-2
F2.113	13-17	Fuel pump driver module (9A311) – 4.6L	23-6
F2.114	13-5	Fuel pump driver module (9A311) – 5.4L	24-6
F2.116	13-5	Fuel pump relay – 4.6L	23-6
F2.118	13-17	Fuel pump relay – 5.4L	24-6
F2.401	13-9	Fuel rail pressure transducer sensor (9F972) – 4.6L	23-1
Floor mode actuator (19E616)	54-2	Fuel rail pressure transducer sensor (9F972) – 5.4L	24-1
Floor mode actuator (19E616) – EATC	55-2	Fuel sender (9H307) – 4.6L	23-6
Floor shifter	37-1	Fuel sender (9H307) – 5.4L	24-6
Fog lamp, left front (15200)	86-1	Fuel tank pressure transducer sensor (9C052) – 4.6L	23-6
Fog lamp, right front (15200)	86-1	Fuel tank pressure transducer sensor (9C052) – 5.4L	24-6
Fog lamp relay	86-1	Fusible link A	13-1
Four-wheel drive switch (14B166)	34-2	Fusible link B	13-1
Fresh/recirculation door actuator (19E616)	54-2	Fusible link C	13-1
Fresh/recirculation door actuator (19E616) – EATC	55-2	G100	10-1
Front blower motor (19805)	54-1	G101	10-1
Front blower motor (19805) – EATC	55-1	G102	10-1
Front blower motor relay	54-1	G103	10-1
Front blower motor relay – EATC	55-1	G104	10-2
Front blower motor speed controller (19E624)	55-1	G105	10-1
Front impact severity sensor (14B006)	46-1	G108	10-2
Fuel injector 1 (9F593) – 4.6L	23-2	G110	10-3
Fuel injector 1 (9F593) – 5.4L	24-2	G200	10-4
Fuel injector 2 (9F593) – 4.6L	23-2	G201	10-7
Fuel injector 2 (9F593) – 5.4L	24-2	G202	10-5
Fuel injector 3 (9F593) – 4.6L	23-2	G203	10-7
Fuel injector 3 (9F593) – 5.4L	24-2	G206	10-6
Fuel injector 4 (9F593) – 4.6L	23-2	G300	10-7
Fuel injector 4 (9F593) – 5.4L	24-2	G301	10-7
Fuel injector 5 (9F593) – 4.6L	23-2	G302	10-7
Fuel injector 5 (9F593) – 5.4L	24-2	G303 – Crew cab / Super cab	10-9
Fuel injector 6 (9F593) – 4.6L	23-2	G303 – Crew cab / Super cab with power equipment	10-10
Fuel injector 6 (9F593) – 5.4L	24-2	G303 – Regular cab	10-8
	23-2	G400	10-11
	24-2	G401	10-11
	23-2	Generator (10346)	12-1



BUY IT NOW!

Click Here To Order 







Headlamp, left (13008)	85-2	Mass Air Flow/Intake Air Temperature (MAF/IAT) sensor – 4.6L	23-3
Headlamp, right (13008)	85-2	Mass Air Flow/Intake Air Temperature (MAF/IAT) sensor – 5.4L	24-3
Heated Oxygen Sensor (HO2S) #11 (9F472) – 4.6L	23-3	Master window adjust switch – Regular cab	100-2
Heated Oxygen Sensor (HO2S) #11 (9F472) – 5.4L	24-3	Memory set switch (14776)	123-4
Heated Oxygen Sensor (HO2S) #12 (9G444) – 4.6L	23-7	Message center switch (8A211)	60-3
Heated Oxygen Sensor (HO2S) #12 (9G444) – 5.4L	24-7	MS-CAN termination resistor	132-2
Heated Oxygen Sensor (HO2S) #21 (9F472) – 4.6L	23-3	Multifunction switch (13K359)	13-20
Heated Oxygen Sensor (HO2S) #21 (9F472) – 5.4L	24-3	Oil pressure switch (9278)	60-1
Heated Oxygen Sensor (HO2S) #22 (9G444) – 4.6L	23-7	Output Shaft Speed (OSS) sensor (7F293)	29-2
Heated Oxygen Sensor (HO2S) #22 (9G444) – 5.4L	24-7	Overdrive cancel switch (7G550)	29-1
Heated seat module, driver side front (14C724)	119-1	Panel mode actuator (19E616)	54-2
Heated seat module, passenger side front (14C724)	119-2	Panel mode actuator (19E616) – EATC	55-2
High beam relay	85-1	Park/stop/turn lamp, left rear	90-2
High mounted stoplamp (13A613)	90-3	Park/stop/turn lamp, right rear	90-2
High pitch horn	44-1	Park/turn lamp, left front (13411)	92-1
Horn (13832)	44-1	Park/turn lamp, right front (13411)	92-1
Horn relay	44-1	Parking aid disable switch (15A860)	131-1
Horn switch	44-1	Parking Aid Module (PAM) (15K850)	131-1
Ignition switch (11572)	13-12	Parking aid sensor, inner left (15K859)	131-2
Ignition transformer capacitor 1 (18801)	21-2	Parking aid sensor, inner right (15K859)	131-2
Ignition transformer capacitor 2 (18801)	21-2	Parking aid sensor, outer left (15K859)	131-2
In-vehicle temperature sensor (19C734)	55-3	Parking aid sensor, outer right (15K859)	131-2
Indicator flasher relay (13350)	90-1	Parking aid speaker	131-2
Inertia Fuel Shutoff (IFS) switch (9341) – 4.6L	23-6	Parking brake switch (15852)	60-2
Inertia Fuel Shutoff (IFS) switch (9341) – 5.4L	24-6	Passenger Air bag Deactivation (PAD) indicator (14B418)	46-1
Instrument cluster (10849)	60-1	Passenger Air bag Deactivation (PAD) switch (14B268)	46-3
Intake Manifold Tuning Valve (IMTV) (9L490) – 4.6L	23-5	Passenger air bag module (15044A74)	46-2
Interior/map lamps assembly, front	89-2	Passive anti-theft transceiver module (15607)	112-1
Interior/map lamps assembly, rear	89-2	PCM power diode	13-15
Key pad switch assembly	117-3	PCM power relay	13-6
Knock sensor 1 (12A699)	21-1	Positive crankcase ventilation heater – 5.4L	24-3
Knock sensor 2 (12A699)	21-1	Power point, console 1	44-2
.	92-2	Power point, console 2	44-2
.	92-2	Power point, instrument panel (19N236)	44-2
.	44-1	Power seat motor assembly, left	120-1
.	13-18	Power seat motor assembly, right	120-2

100% SATISFACTION GUARANTEED

BUY IT NOW!

Click Here To Order

PayPal American Express Discover MasterCard VISA

Power sliding window motor, rear (15422A12)	100-5	S110	10-3
Power sliding window switch	100-5	S111	13-17
Power steering pressure sensor - 4.6L	23-4	S112	13-14
Power steering pressure sensor - 5.4L	24-4	S113	13-13
Powertrain Control Module (PCM) (AAA1001) - 4.6L	23-1	S114	13-8
Powertrain Control Module (PCM) (AAA1001) - 5.4L	24-1	S115	13-19
Power window motor, driver side front (1523201) - Regular cab	100-2	S116	10-3
Power window motor, left rear (1627001) - Super cab, Crew cab	100-4	S117	14-1
Power window motor, passenger side front (1523200) - Regular cab	100-2	S118	14-1
Power window motor, right rear (1627000) - Super cab, Crew cab	100-4	S119	13-1
Rear axle speed sensor (2L373)	42-1	S120	13-1
Rear interior lamp	89-2	S121	13-1
Rear window defrost grid (18C618)	56-1	S129	13-8
Rear window defrost relay	56-1	S131	13-8
Restraints control module (14B321)	46-1	S135 - 4.6L	23-4
Reversing lamp, left (13411)	93-1	S135 - 5.4L	24-4
Reversing lamp, right (13411)	93-1	S136 - 4.6L	23-4
Roof opening panel module (502D70)	101-2	S136 - 5.4L	24-4
Roof opening panel switch (14529)	101-2	S140	13-7
S100	10-2	S141 - 4.6L	23-7
S101	54-3	S141 - 5.4L	24-7
S101	55-4	S154	13-7
S102	10-1	S161	13-16
S103	13-8	S162	13-16
S104 - 4.6L	23-6	S170	13-16
S104 - 5.4L	24-6	S199	10-1
S105	13-3	S200	10-7
S106 - 4.6L	23-5	S201	10-5
S106 - 5.4L	24-5	S202	54-2
S107	13-7	S202 - EATC	55-2
S108	13-8	S203	10-5
S109	90-3	S204	54-2
		S204 - EATC	55-2
		S205	10-5
		S206	130-5
		S208	10-4

SATISFACTION 100% GUARANTEED

BUY IT NOW!

Click Here To Order

PayPal American Express Discover MasterCard VISA

S212	13-11	S293	46-3
S215	132-2	S294	46-3
S216 – Crew cab / Super cab	10-9	S295	13-10
S216 – Regular cab	10-8	S296	31-2
S218	13-8	S299	13-12
S220	13-1	S300	10-7
S222	37-1	S301	123-2
S224	13-18	S302	123-2
S225	13-15	S308	10-6
S228	13-14	S309	10-7
S231	90-3	S310 – Crew cab / Super cab with power equipment	10-10
S236	13-2	S314	10-4
S239	130-5	S315	13-2
S240	13-10	S320	13-17
S242	71-1	S322	13-5
S243	132-2	S323	13-15
S246	90-2	S324	10-7
S247	90-2	S325	89-2
S265	13-15	S326	10-4
S266	13-3	S327	130-5
S267	13-18	S328	13-11
S275	54-1	S329	10-7
S276	71-2	S331	13-9
S277	13-13	S332	13-19
S278	13-20	S333	90-3
S279	130-5	S334	13-4
S280	14-2	S335	14-2
S281	14-2	S336	132-2
S282	37-1	S337 – Super cab, Crew cab	100-4
S283	10-5	S338	13-11
S284	29-1	S339	110-2
S285	13-9	S340 – Crew cab / Super cab with power equipment	10-10
	13-5	S341	110-1
	14-1	S342	110-2
	14-1	S343	110-1
	13-12	S344	13-9

100% SATISFACTION GUARANTEED

BUY IT NOW!

Click Here To Order

PayPal American Express Discover MasterCard VISA

S345	13-2	Seat adjust switch, driver side front (14A701) – memory seat	123-1
S355	10-6	Seat adjust switch, passenger side front	120-2
S380	10-5	Seat back heater, left front	119-1
S4000	131-2	Seat back heater, right front	119-2
S4001	131-2	Seat cushion heater, left front	119-1
S401	10-11	Seat cushion heater, right front	119-2
S403	13-19	Seat position sensor, driver (14B416)	46-4
S405	13-4	Seat pressure sensor (603B02)	46-3
S406	13-21	Seat weight sensor module (603B02)	46-3
S407	13-21	Side lamp, left front (13411)	92-1
S408	13-4	Side lamp, right front (13411)	92-1
S409	10-11	Speaker, left front (18808)	130-2
S410	13-4	Speaker, left rear (18808)	130-2
S411	10-11	Speaker, right front (18808)	130-2
S501	124-1	Speaker, right rear (18808)	130-2
S502 – Crew cab / Super cab	10-9	Speed control switch (9C888)	31-2
S502 – Regular cab	10-8	Starter motor (11000)	20-1
S503	124-2	Starter relay (11450)	20-1
S600	10-6	Subwoofer (18C808)	130-5
S603 – if equipped	124-2	Temperature blend door actuator (19E616)	54-2
S900	89-2	Temperature blend door actuator (19E616) – EATC	55-2
S904	13-10	Throttle Position Sensor (TPS) (9F991) – 4.6L	23-6
S905 – Crew cab / Super cab with power equipment	10-10	Throttle Position Sensor (TPS) (9F991) – 5.4L	24-6
S906	132-2	Trailer electronic brake control module	95-2
S907	132-2	Trailer tow connector (15A416)	95-1
S908	132-2	Trailer tow relay, battery charge	95-2
S909	13-14	Trailer tow relay, parking lamp	92-1
S910	10-6	Trailer tow relay, reversing lamp	93-1
S912	13-10	Transfer case assembly	34-1
S915	132-2	Transfer case speed sensor	34-1
Safety belt buckle pretensioner, driver	46-1	Turbine shaft speed (TSS) sensor (7H103)	29-2
Safety belt buckle pretensioner, passenger	46-1	Vanity mirror lamp, left (04100)	89-3
Safety belt buckle switch, driver	46-4	Vanity mirror lamp, right (04100)	89-3
Safety belt buckle switch, passenger	46-4	Variable Camshaft Timing (VCT) valve 1 (6B297) – 5.4L	24-5
Safety belt buckle switch, right	46-3	Variable Camshaft Timing (VCT) valve 2 (6B297) – 5.4L	24-5
Safety belt buckle switch, left	46-3	Wheel speed sensor, left front (2C205)	42-1
Safety belt buckle switch, left (701)	120-1		

100% SATISFACTION GUARANTEED

BUY IT NOW!

Click Here To Order

PayPal American Express Discover MasterCard VISA

Wheel speed sensor, right front (2C204) 42-1
Window adjust switch, left rear (14A412) – Super cab,
Crew cab 100-4
Window adjust switch, passenger side (14529A) – Regular cab .. 100-2
Window adjust switch, right rear (14A412) – Super cab,
Crew cab 100-4
Windshield washer pump motor (19E561) 81-2
Windshield wiper motor (17526) 81-1

100% SATISFACTION GUARANTEED
BUY IT NOW!
Click Here To Order

PayPal American Express Cards DISCOVER NOVUS MasterCard VISA

Note

All wiring connections between components are shown exactly as they exist in the vehicles. It is important to realize, however, that no attempt has been made on the schematic to represent components and wiring as they physically appear on the vehicle. For example, a 4-foot length of wire is treated no differently in a schematic from one which is only a few inches long. Furthermore, to aid in understanding electrical (electronic) operation, wiring inside complicated components has been simplified.

Complete Circuit Operation

Each circuit is shown completely and independently in one cell. Other components which are connected to the circuit may not be shown unless they influence the circuit operation.

Current Flow (1)

Each cell normally starts with the component that powers the circuit, such as a fuse or the ignition switch. Current flow is shown from the power source at the top of the page to ground at the bottom of the page. In order to concentrate on the essential parts, power supply and ground connections are sometimes simplified by a dashed line in the schematics. A full representation of the power supply of a fuse or the power distribution from a fuse to various components is given in cell 13 "Power Distribution". Full representation of the ground connections are shown in cell 10 "Grounds".

Switch Positions (2)

Within the schematic, all switches, sensors and relays are shown "at rest" (as if the Ignition Switch were OFF).

Splices (3)

A dashed line indicates that the splice is not shown completely. A reference to other pages in full. It is also listed in the

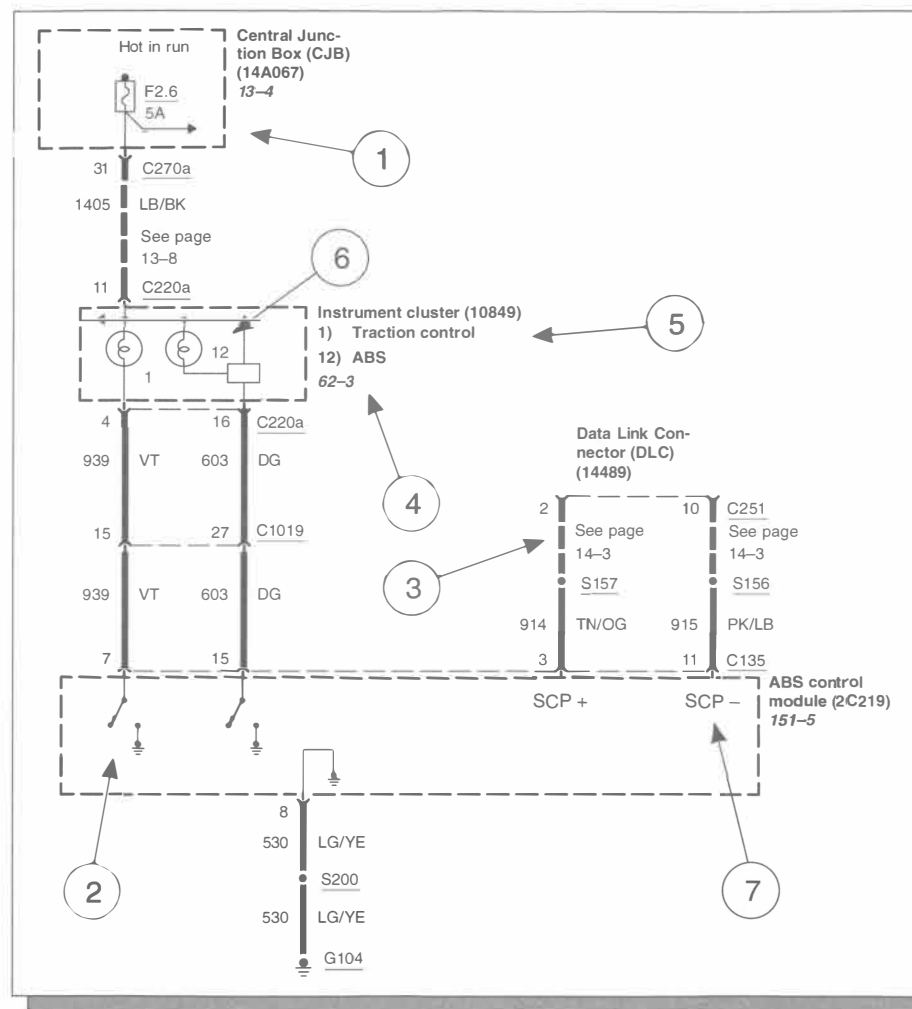

100% SATISFACTION GUARANTEED

BUY IT NOW!

Click Here To Order

PayPal American Express Discover Novus MasterCard VISA

Component Referencing (4)

Each component on a schematic has a reference to the component location view or the page where it is shown completely. It is located to the right of each component.

Component Names, Notes and Base Part Numbers (5)

Component names are placed on the right hand side of each component. Any notes that describe switch positions or operating conditions follow the name. Descriptions of the internals of the component are also included here. The page where the component appears in full is listed in the Index. The base part number for a component is listed in parentheses next to or under a component. These part numbers will appear any place the component name appears in the publication.

Internal Name and Function Identification Numbers (6)

Some components on each page have internal symbols with an identification number located to the right. You can identify the internal symbol or function by finding the corresponding number under the component name.

Circuit Function Identifiers (7)

Some components without internal schematics use symbols or text to describe the function of a circuit in a system.



Fuse and Relay Information

Cell 11 “Fuse and Relay Information” contains a view of the fuse-/relay box in which all fuses and relays are identified.

Fuse and Relay Numbering and Naming

Fuse and relay numbering and naming follow the indication of the fuse panel cover. In addition, a prefix precedes the fuse number to facilitate finding the fuse in the Component Location Charts, e.g. “F1.” precedes Battery Junction Box fuses, and “F2.” precedes Central Junction Box fuses.

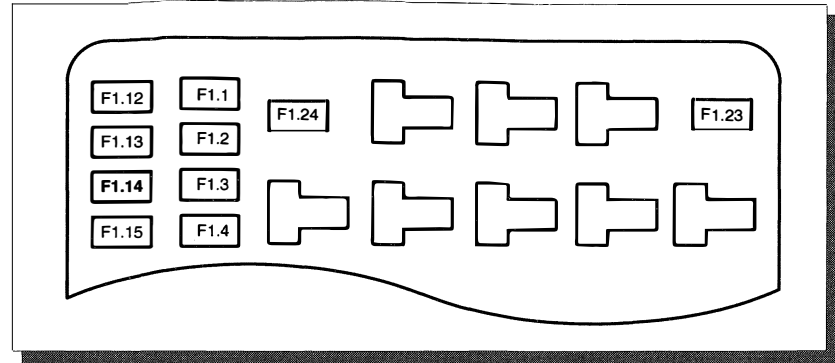

Power Distribution

Cell 13 “Power Distribution” shows the current feed circuit. The current path is shown from the battery to the ignition switch and to all fuses. It also shows the circuits protected by each fuse. The circuit is traced from the fuse to the component. All details (wires, splices, connectors) between the fuse and the first component are shown.

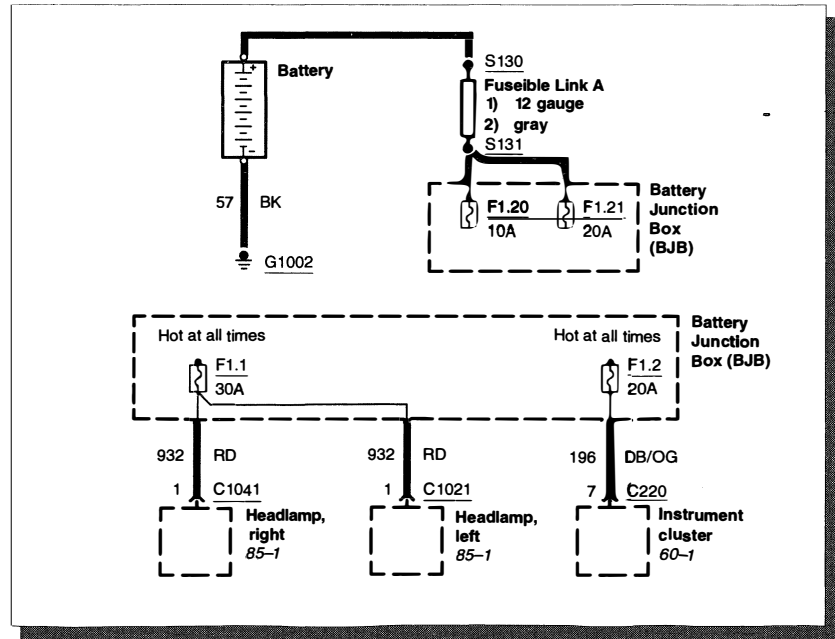

100% SATISFACTION GUARANTEED

BUY IT NOW!

Click Here To Order

PayPal, American Express, Discover, MasterCard, VISA

Ground Distribution

Cell 10 “Grounds” contains the schematics that show the complete details for each ground connection or main ground splice. This is useful in diagnosing a problem affecting several components at once (poor ground connection or ground splice). All details (wires, splices, connectors) between the ground point and the components are shown. These ground connection details are shown here in order to keep the individual cell schematics as uncluttered as possible.

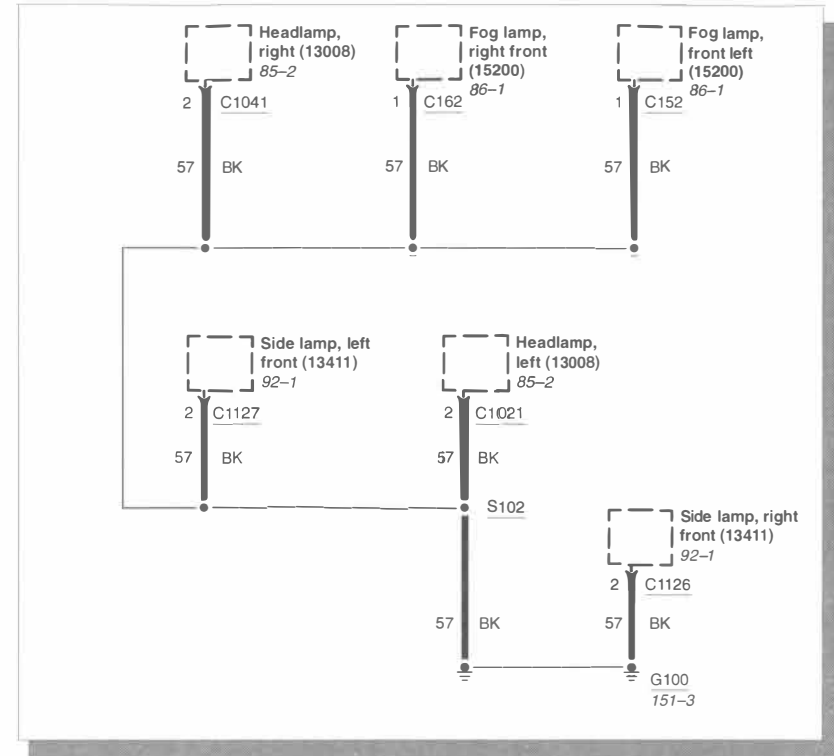

100% SATISFACTION GUARANTEED

BUY IT NOW!

Click Here To Order

Component and Connector Information

Cell 152 “Component Location Charts” helps the user find where the various items depicted on the schematic can physically be found on the vehicle. A brief written description of the location is given, along with a reference to the component location views.

Cell 151 “Component Location Views” show the components and their connecting wires as they can be found on the vehicle.

Cell 150 “Connector Views” show the views of the pins and/or cavities of all connectors. The pin and cavity sides are shown separately as if the connector were disconnected. The color of the connector housing is indicated next to the connector number when available. The harness causal number is located above the component name and below the connector number or above the connector face itself. Wiring harness designations are listed in cell 152 “Component Location Charts”. Circuit function charts are located below each connector.

C150 (BK)

12A581

Wheel speed sensor, left front (2C205)

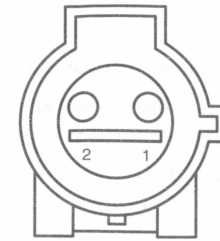

FEMALE

Pin	Circuit	Circuit Function
1	522 (TN/BK)	Wheel speed sensor, left front (2C205) -
2	521 (TN/OG)	Wheel speed sensor, left front (2C205) +

C1033 (BK)

12B637

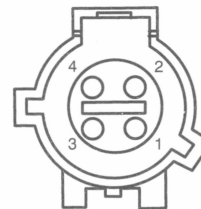

FEMALE

- (1) -
- (2) 1102 (YE/LG)

14B102

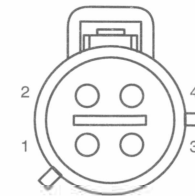

MALE

- (3) 359 (GY/RD)
- (4) -

SATISFACTION 100% GUARANTEED

BUY IT NOW!











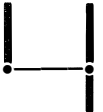







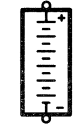

Click Here To Order

WARNINGS

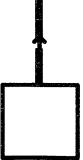
- *Always wear safety glasses for eye protection.*
- *Use safety stands whenever a procedure requires being under a vehicle.*
- *Be sure that the **Ignition Switch** is always in the OFF position, unless otherwise required by the procedure.*
- *Set the parking brake when working on any vehicle. An automatic transmission should be in PARK. A manual transmission should be in NEUTRAL.*
- *Operate the engine only in a well-ventilated area to avoid danger of carbon monoxide.*
- *Keep away from moving parts, especially the fan and belts, when the engine is running.*
- *To prevent serious burns, avoid contact with hot metal parts such as the radiator, exhaust manifold, tail pipe, catalytic converter and muffler.*
- *Do not allow flame or sparks near the battery. Gases are always present in and around the battery cell. An explosion could occur.*
- *Do not smoke when working on a vehicle.*
- *To avoid injury, always remove rings, watches, loose hanging jewelry and avoid wearing loose clothing.*



4-1 Symbols

	Distributed splice		Entire component		Resistor
	Crossed wiring without connection		Part of a component		Potentiometer (pressure or temperature)
	Splice		Component case directly attached to metal part of vehicle (ground)		Potentiometer (outside influence)
	Removable connection		Component with screw terminals		Battery
	Ground		Connector attached to component		Fuse
	Connector		Connector attached to component lead (pigtail)		Circuit breaker
	Female connector		Positive Temperature Coefficient (PTC)		Heating element, Conductor loop
	Male connector				
	Twisted pair				

100% SATISFACTION GUARANTEED

BUY IT NOW!

Click Here To Order





Ignition coil assembly

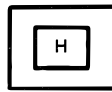

Hall sensor



Antenna



Solenoid controlled valve or clutch solenoid



Air bag sliding contact (14A664)



Permanent magnet, one-speed-motor



Light emitting diode (LED)



Diode, current flows in direction of arrow



Permanent magnet, two-speed-motor



Capacitor



Transistor



Rotational sensor



Variable capacitor



Lamp

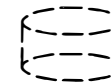

Shield



Piezoelectric sensor

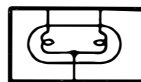

Bifilament lamp



Horn or speaker



Coil



Gauges



Fusible link

100% SATISFACTION GUARANTEED

BUY IT NOW!

Click Here To Order

4-3 Symbols

Wire colors	
BK	Black
BN	Brown
BU	Blue
DB	Dark blue
DG	Dark green
GN	Green
GY	Gray
LB	Light blue
LG	Light green
NA	Natural
OG	Orange
PK	Pink
RD	Red
SR	Silver
TN	Tan
VT	Violet
WH	White
YE	Yellow

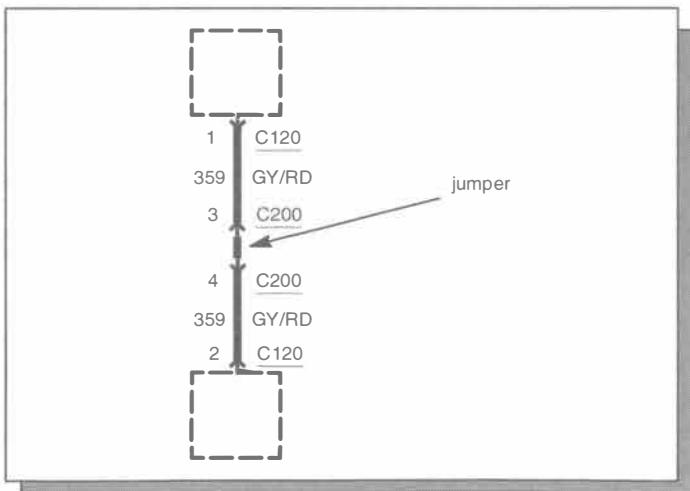
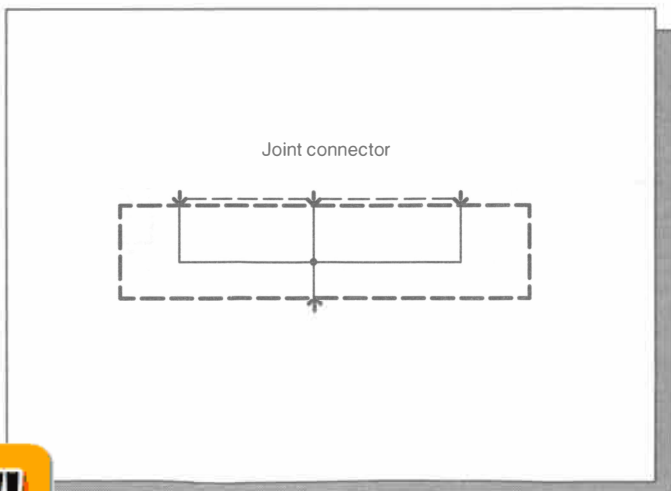
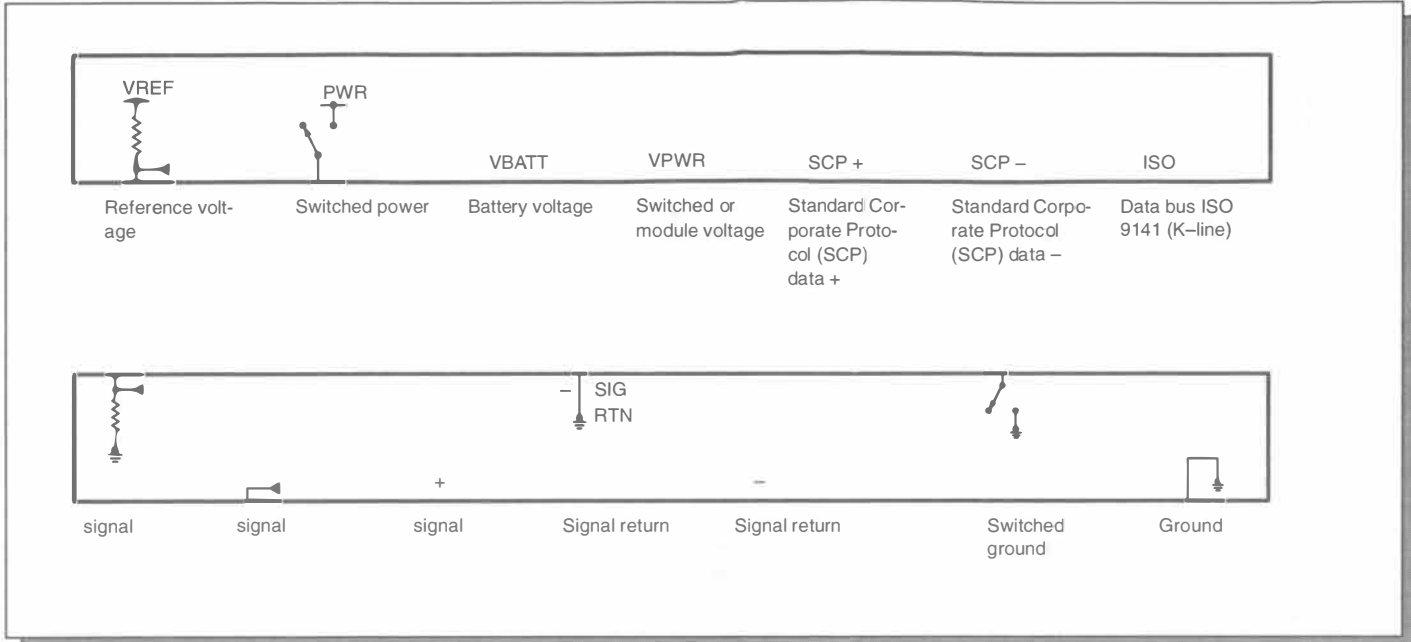

100% SATISFACTION GUARANTEED

BUY IT NOW!

Click Here To Order

PayPal, American Express, Discover, MasterCard, VISA

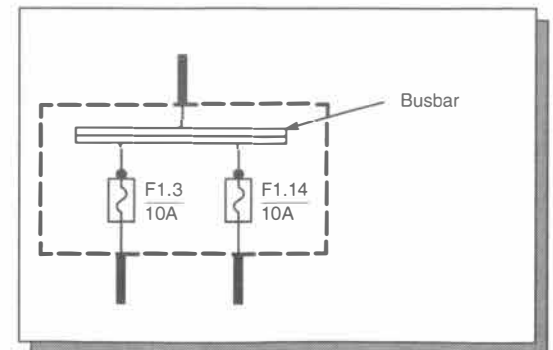
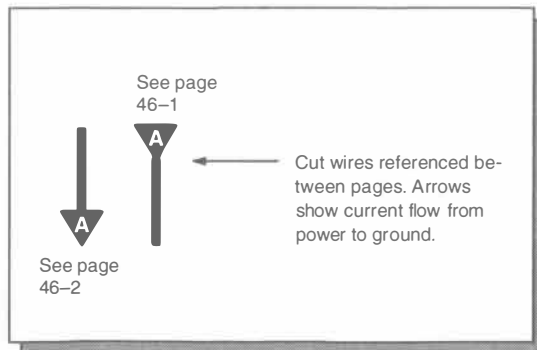
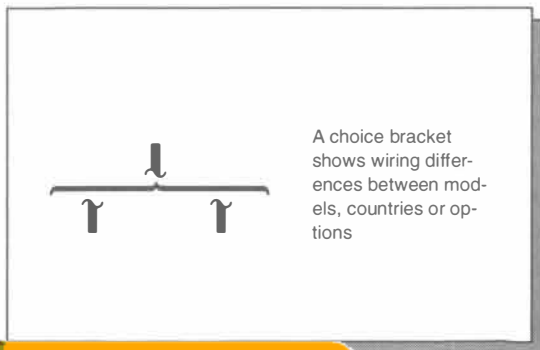
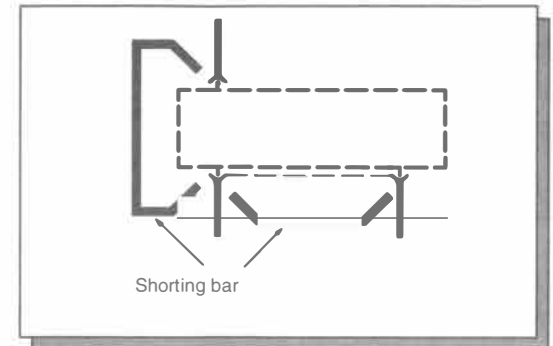
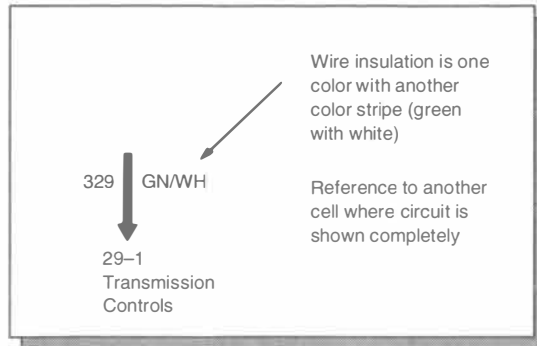
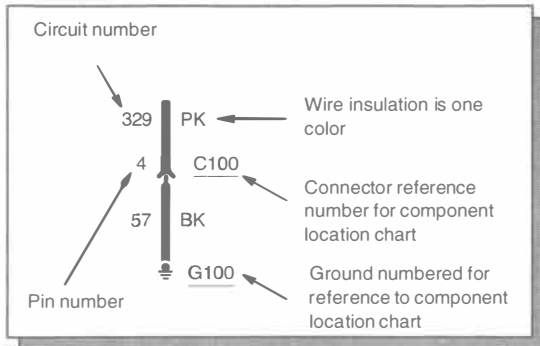
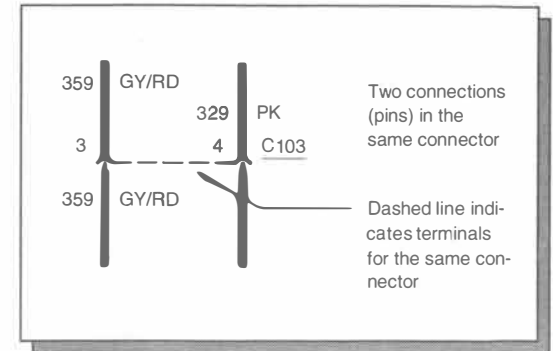
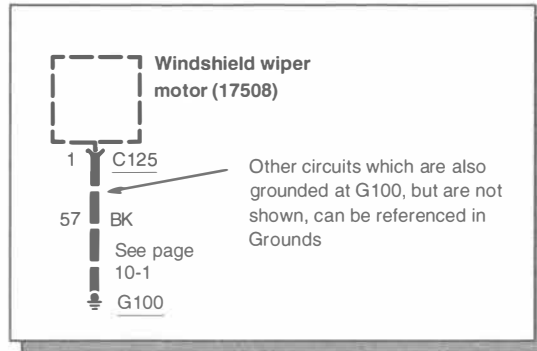
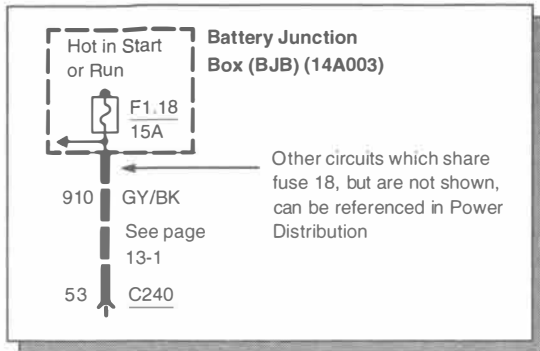

100% SATISFACTION GUARANTEED

BUY IT NOW!

Click Here To Order

PayPal American Express Discover NOWUS MasterCard VISA

4-5 Symbols

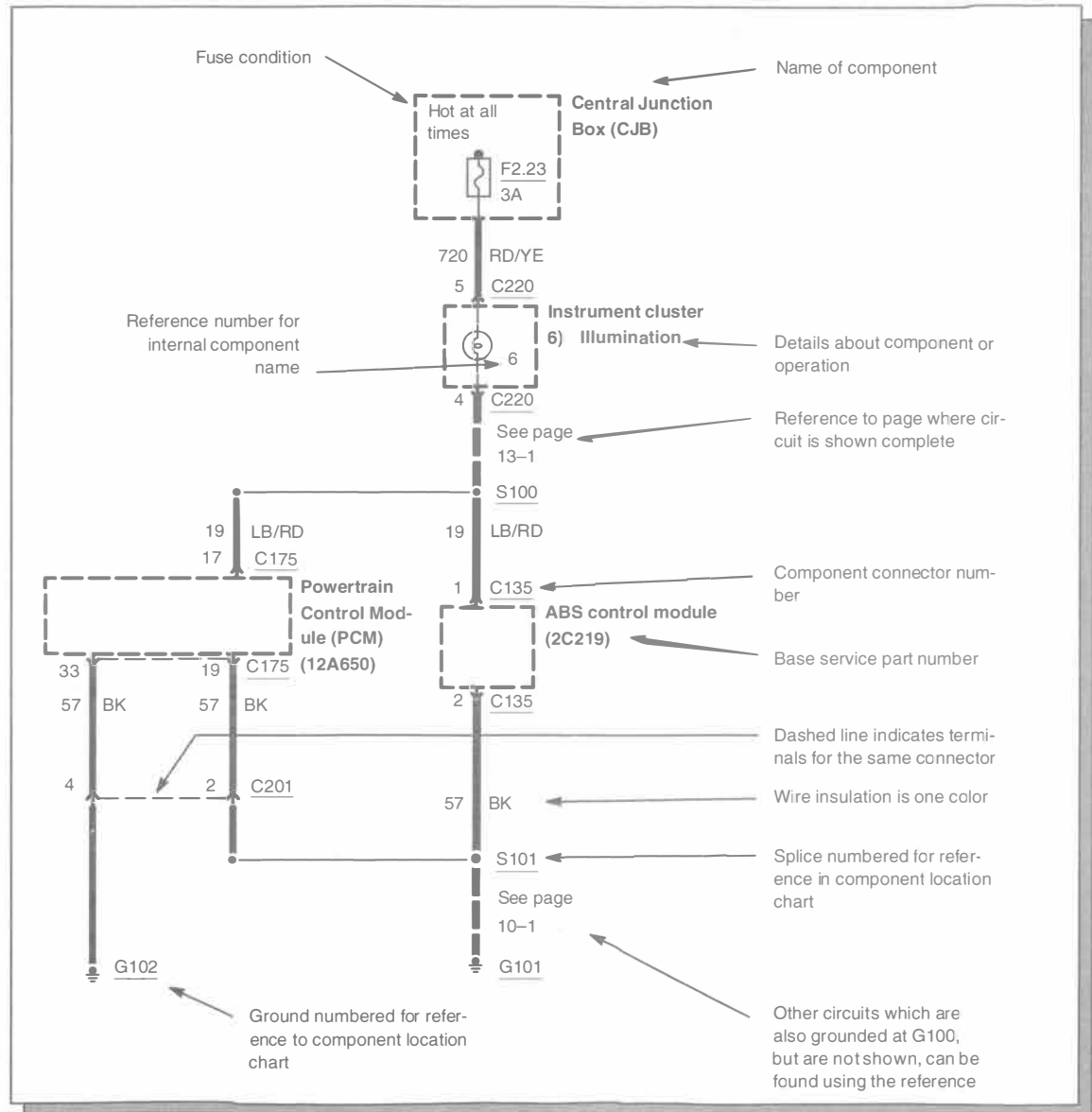
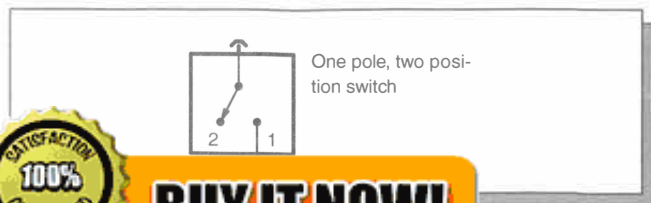
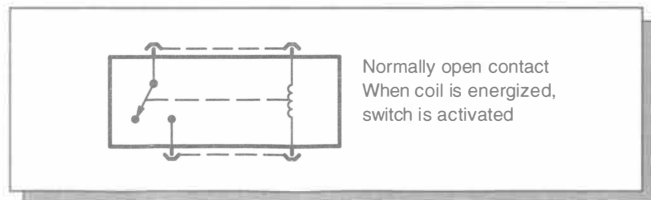
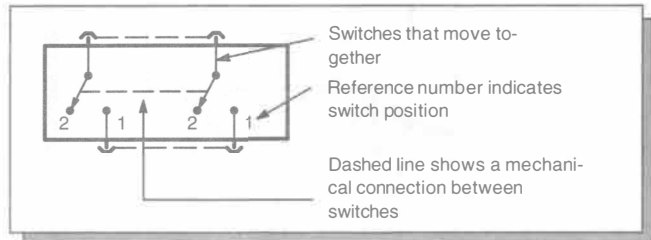
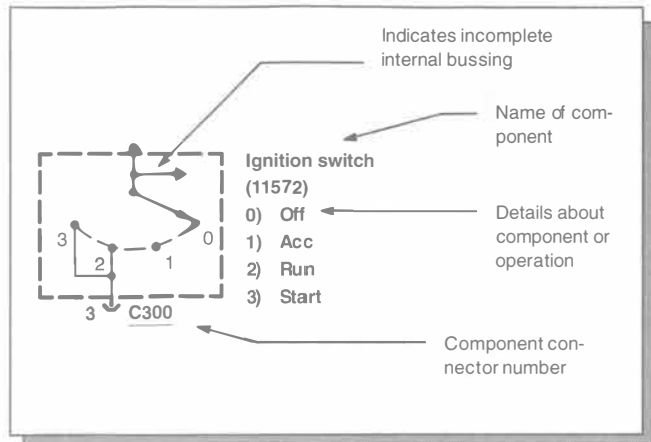

100% SATISFACTION GUARANTEED

BUY IT NOW!

Click Here To Order

PayPal American Express Discover MasterCard VISA

The first digit of every connector, ground, and splice number used in this publication references its location within the vehicle.

The chart below describes the different sections of the vehicle, and lists the number associated with each.

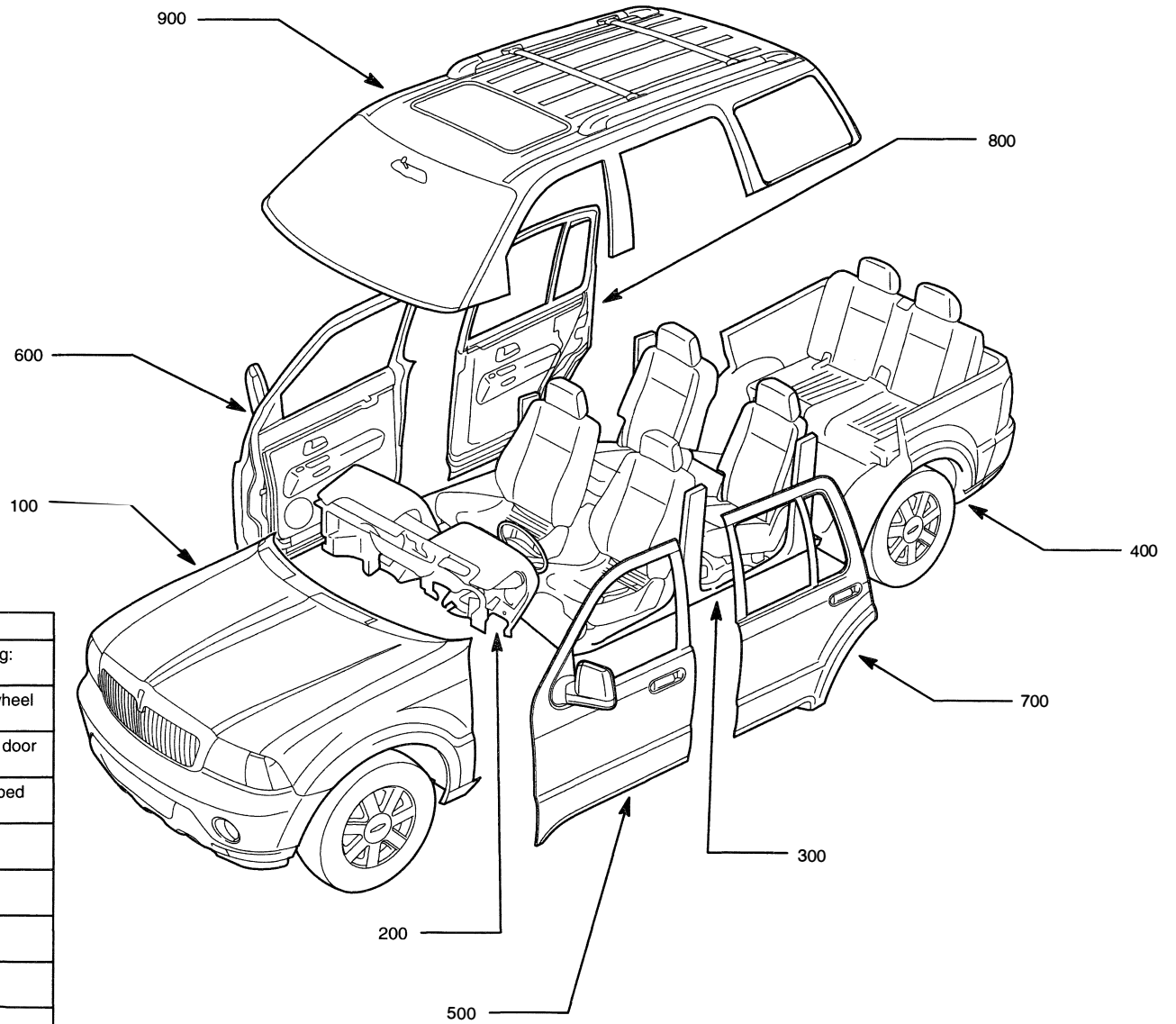

Number	Location
100	Engine compartment, Powertrain (including: axle/differential/transmission)
200	Instrument Panel and Console, Steering wheel assembly
300	From instrument panel to rear seat, below door trim panel
400	behind rear seats, to rear bumper; Truck bed
500	driver door
600	passenger door, front
700	passenger door, left rear
800	passenger door, right rear
900	Roof rack

100% SATISFACTION GUARANTEED

BUY IT NOW!

Click Here To Order

Troubleshooting wiring harness and connector hidden concerns

The following illustrations are known examples of wiring harness, splices and connectors that will create intermittent electrical concerns. The concerns are hidden and can only be discovered by a physical evaluation as shown in each illustration.

NOTE: Several components, such as the PCM, utilize gold plated terminals in their connections to the wiring harness. If those terminals need to be replaced, they must be replaced with a gold plated terminal.

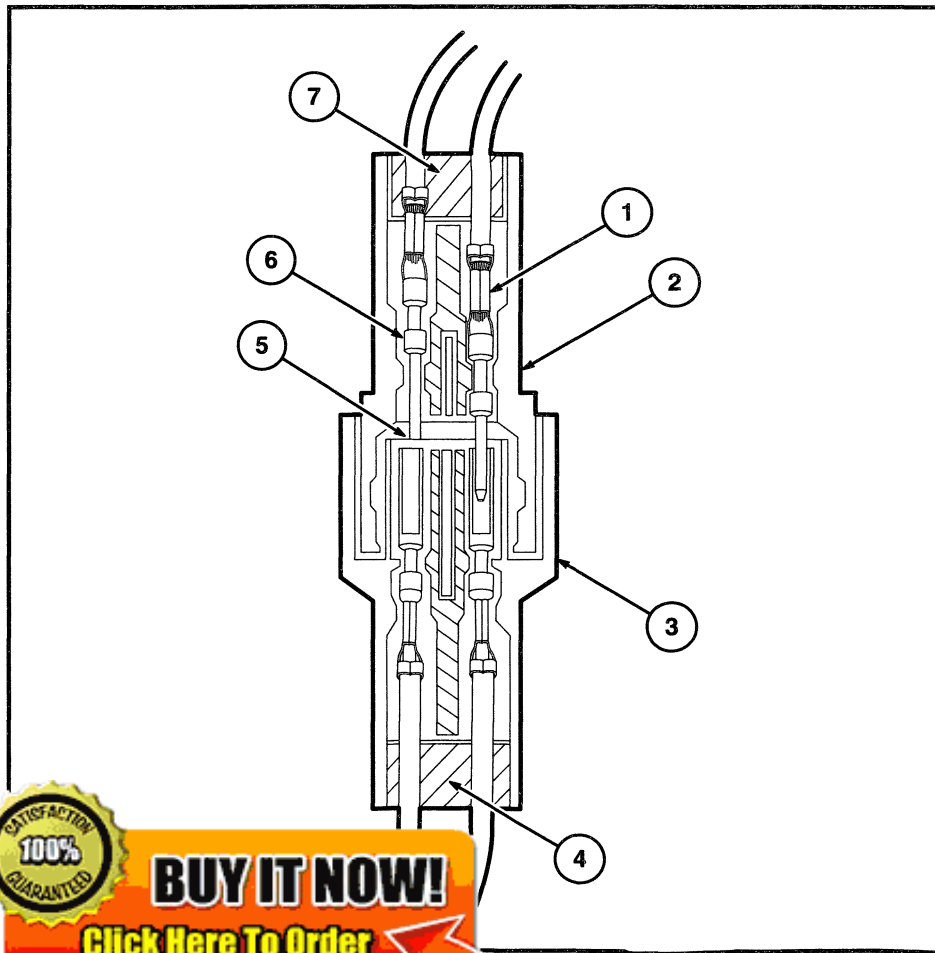

Terminal not properly seated

- 1 = Locked terminal
- 2 = Male half
- 3 = Female half
- 4 = Seal
- 5 = Intermittent contact
- 6 = Unlocked terminal (Hidden by wire seal)
- 7 = Seal

Check for unlocked terminals by pulling each wire at the end of the connector.

100% SATISFACTION GUARANTEED

BUY IT NOW!

Click Here To Order

PayPal American Express DISCOVER MasterCard VISA

Defective insulation stripping

- 1 = Proper crimp
- 2 = Insulation not removed
- 3 = Wire strands missing
- 4 = Intermittent signals through pierced insulation

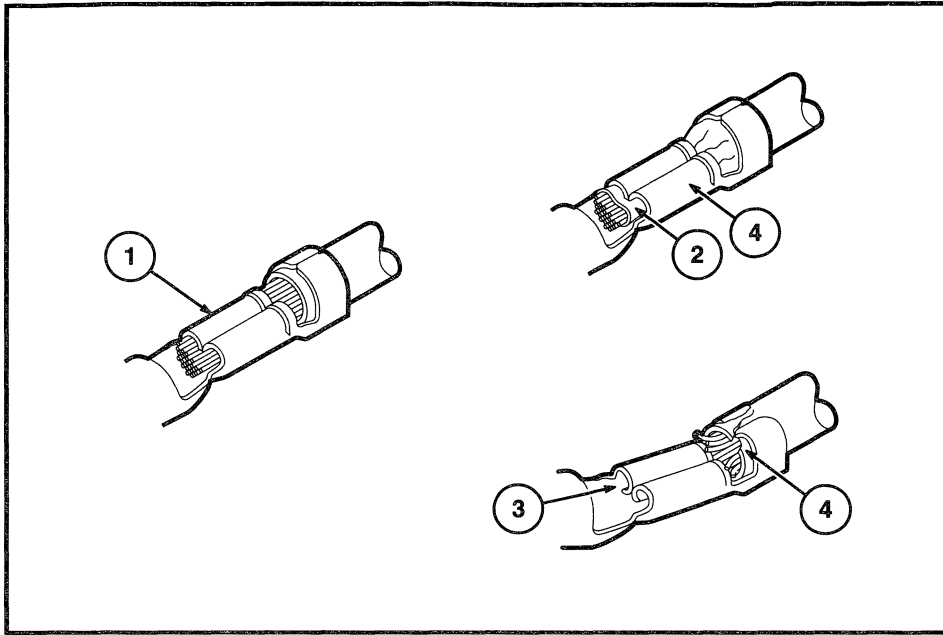

Partially mated connectors

- 1 = Seal
- 2 = Displaced tab
- 3 = Female half
- 4 = Seal
- 5 = Intermittent contact
- 6 = Male half
- 7 = Intermittent contact

Lock may be displaced into an unlocked position; pull on the connector to verify the lock.

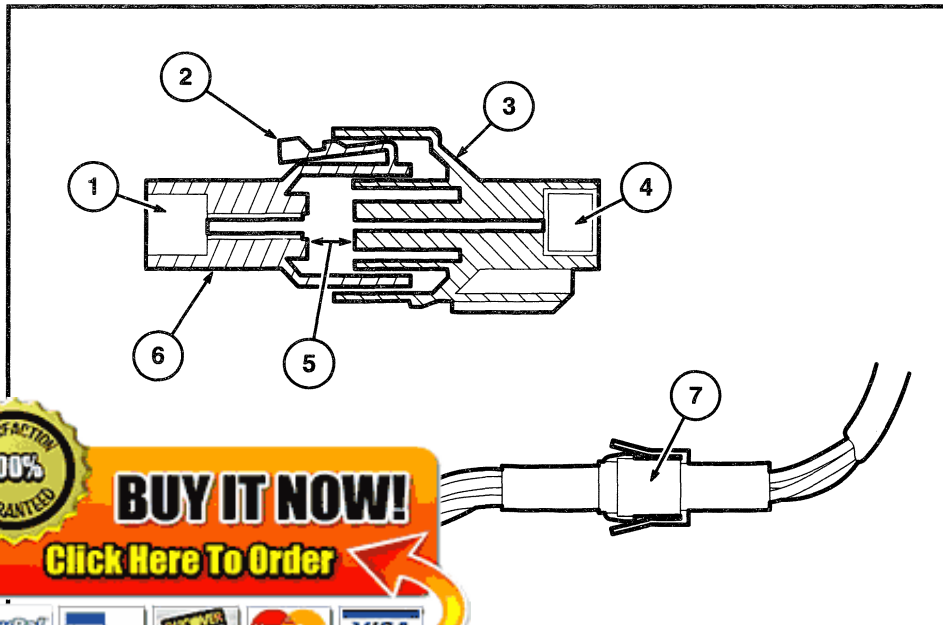

100% SATISFACTION GUARANTEED

BUY IT NOW!

Click Here To Order

PayPal American Express Discover MasterCard VISA

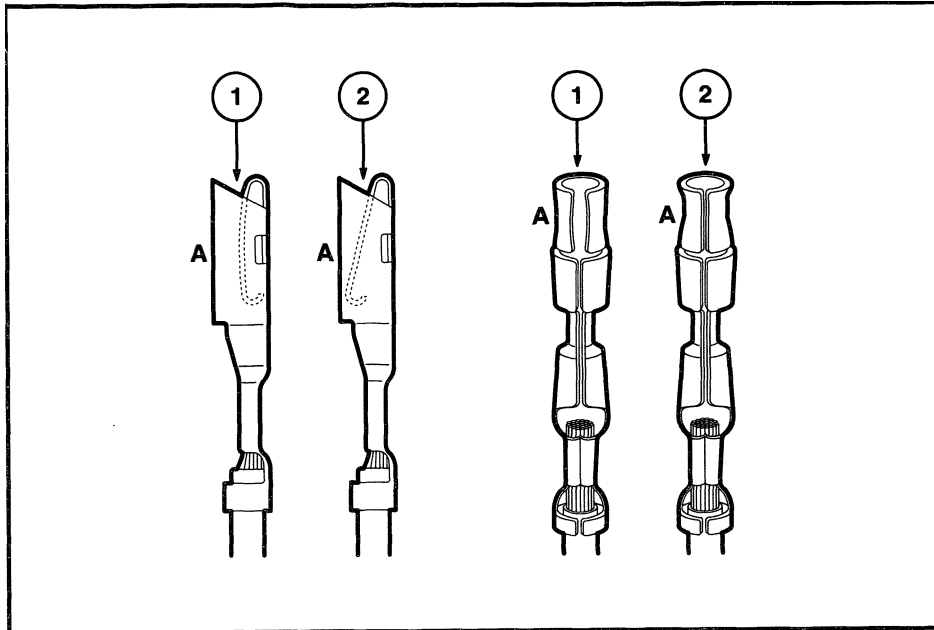

Deformed (enlarged) female terminals

- 1 = Enlarged
- 2 = Normal

Any probe entering the terminal may enlarge the contact spring opening creating an intermittent signal. Insert the correct mating terminal (Location A) from the service kit and feel for a loose fit.

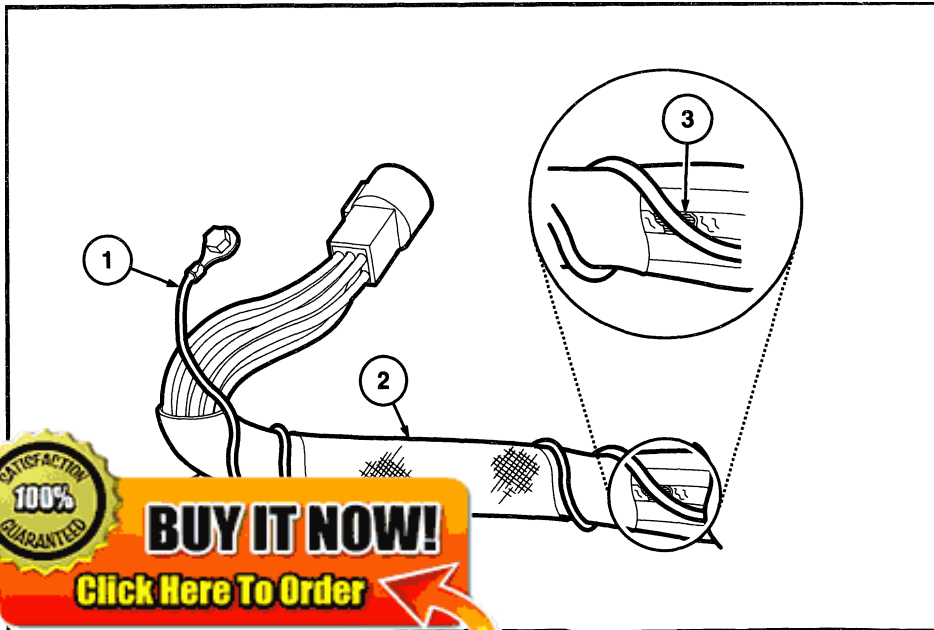

Electrical short inside the harness

- 1 = Solder coated wire to ground
- 2 = Harness protective tape
- 3 = Intermittent short
Solder coated wire pierced through the insulation of another circuit
- 4 = Grounding foil

100% SATISFACTION GUARANTEED

BUY IT NOW!

Click Here To Order

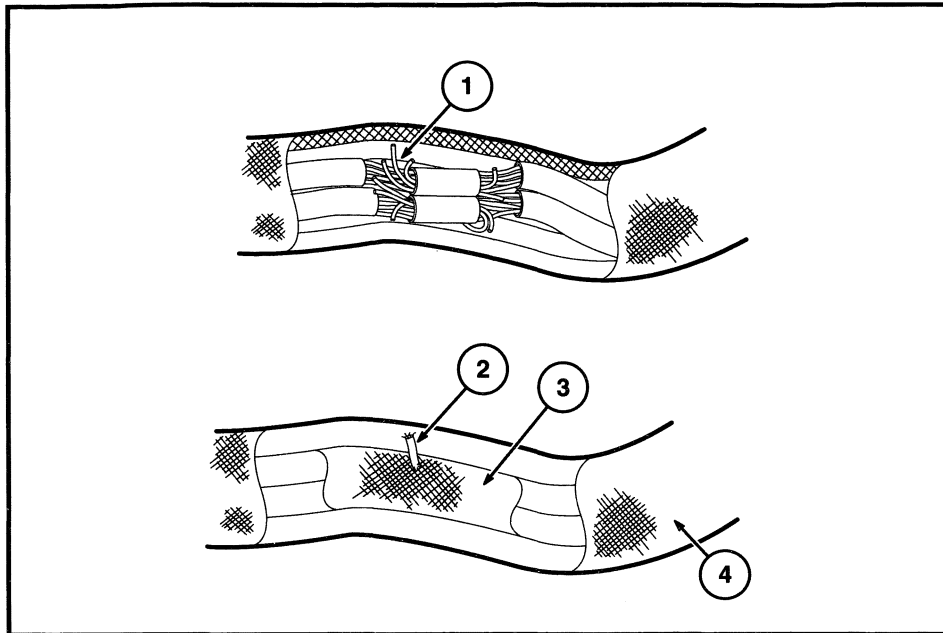

Electrical short within the harness

Splice tape removed

1 = Intermittent short

Splice covered

2 = Wire strand

3 = Splice tape

4 = Harness tape

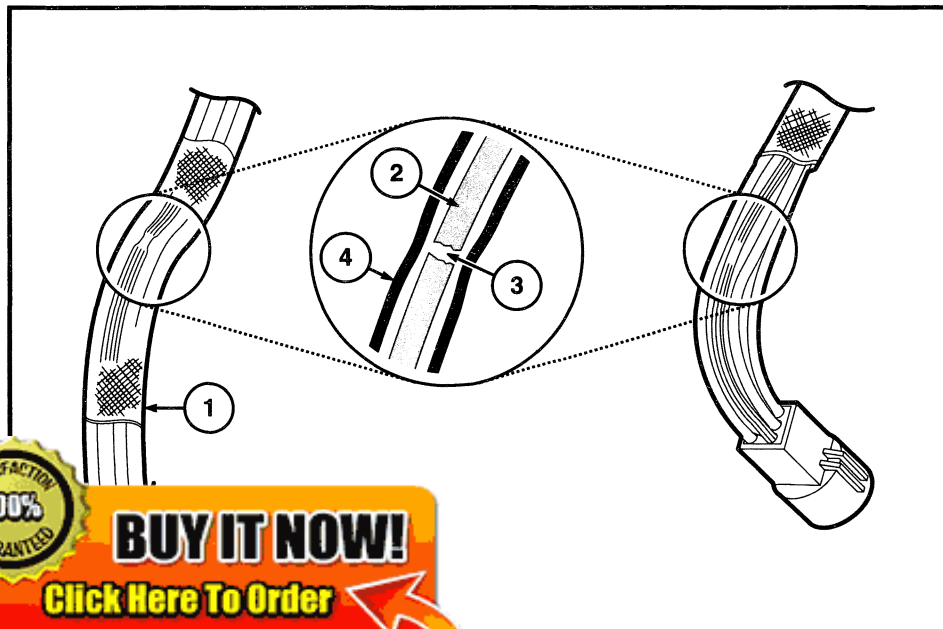

Broken wire strands in harness

1 = Wiring harness tape

2 = Wiring strand

3 = Broken strands intermittent signal

4 = Circuit insulation

Remove the tape and flex/feel each circuit for a reduction in diameter at break.

100% SATISFACTION GUARANTEED

BUY IT NOW!

Click Here To Order

Recommended splicing method

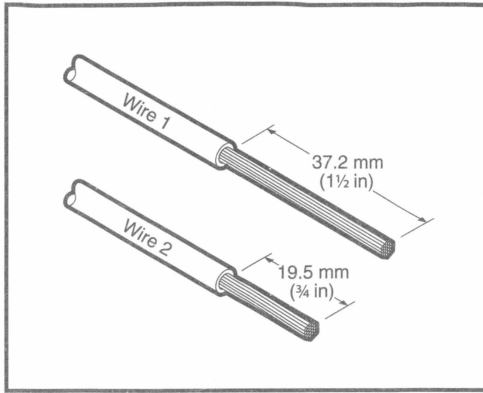

1. Disconnect battery ground cable.
2. Strip wires to appropriate length.

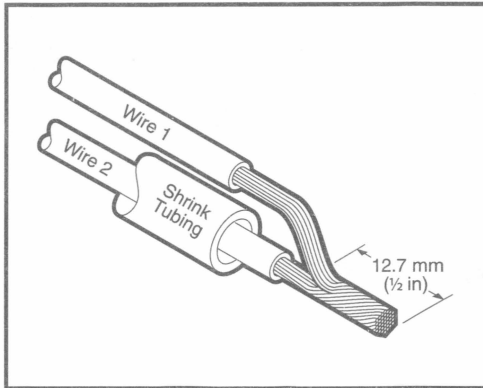

3. Install heat shrink tubing.
 4. Twist wires together.
 5. Solder wires together.
- NOTE:** Use rosin core mildly-activated (RMA) solder. Do not use acid core solder.



6. Bend Wire 1 back in a straight line.
- NOTE:** Wait for solder to cool before moving wires.

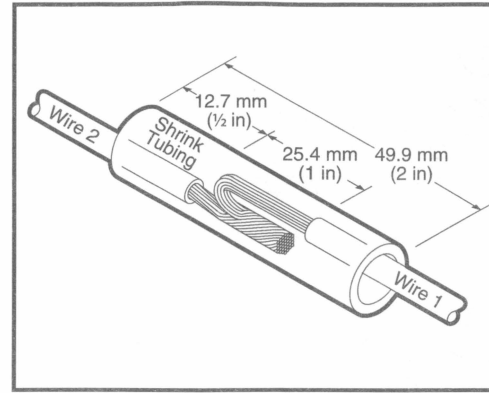

7. Evenly position heat shrink tubing over wire repair.

NOTE: Overlap tubing on both wires.

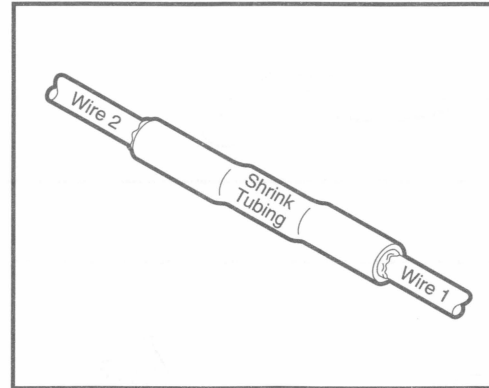

8. Use heat gun to heat the repaired area until adhesive flows out of both ends of heat shrink tubing.
9. Reconnect battery ground cable.

100% SATISFACTION GUARANTEED

BUY IT NOW!

Click Here To Order

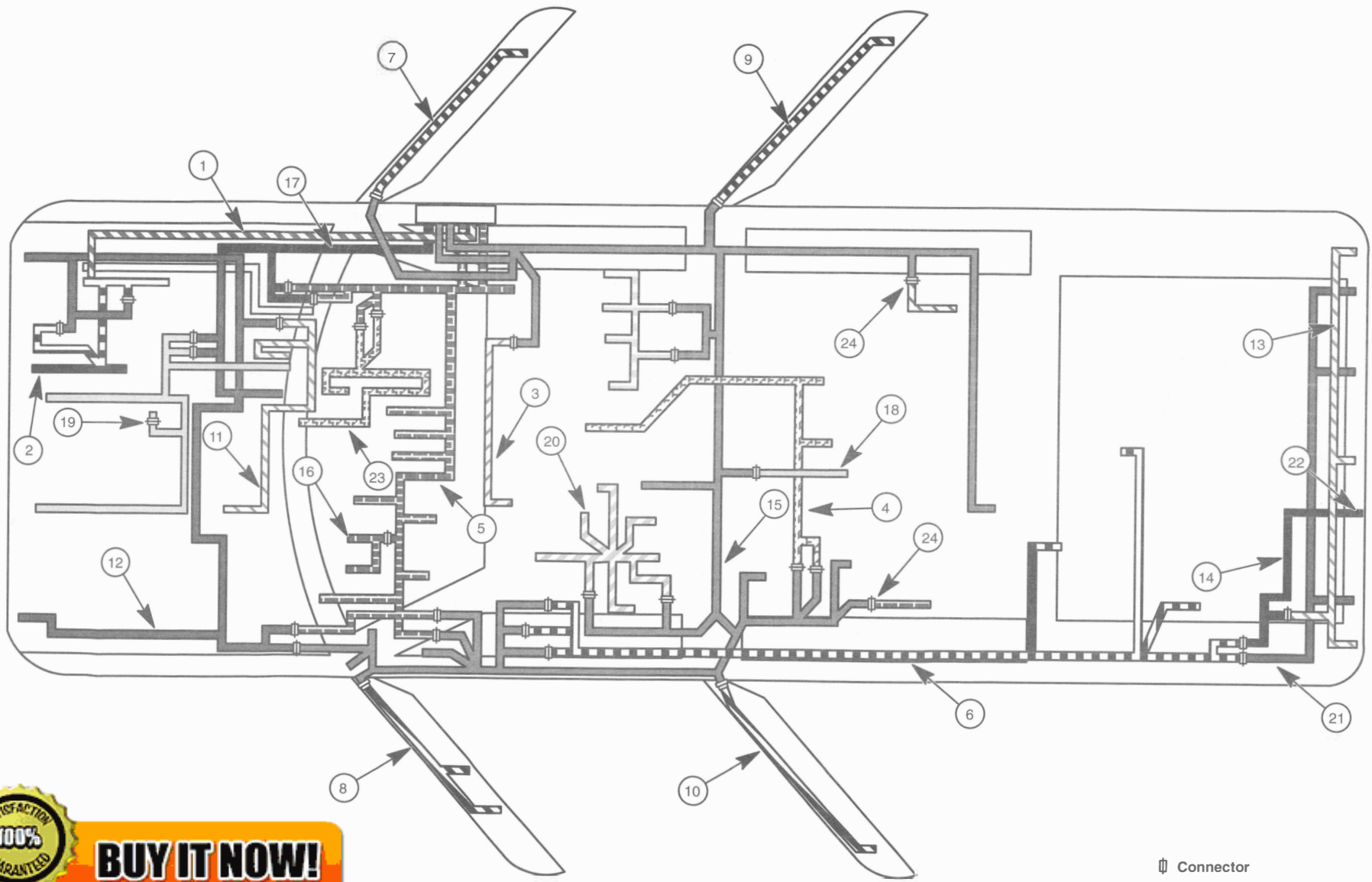

⊞ Connector
⊞ Grommet

100% SATISFACTION GUARANTEED

BUY IT NOW!

Click Here To Order 

PayPal | American Express | Discover | MasterCard | VISA

Item	Part Number	Description
1	14300	Wiring harness – Battery output
2	14305	Wiring harness – Alternator rectifier system
3	14334	Wiring harness – Interior lamps
4	14358	Wiring harness – Dome lamp connector
5	14401	Wiring harness – Main
6	14405	Wiring harness – Tail lamps
7	14630	Wiring harness – Window regulator, right front door
8	14631	Wiring harness – Window regulator, left front door
9	14632	Wiring harness – Window regulator, right rear door
10	14633	Wiring harness – Window regulator, left rear door
11	15525	Wiring harness – Back up lamp switch to rear lamp feed
12	12A581	Wiring harness – Engine control sensor
13	13A409	Wiring harness – Rear lamp connector
14	13A576	Wiring harness – Trailer lamp feed
15	14A005	Wiring harness – Body main
16	13A576	Wiring harness – Headlamp dimmer switch, jumper
17	14A005	Wiring harness – Starter motor relay and battery ground
18	14A320	Wiring harness – Console panel
19	14B060	Wiring harness – Temperature sensor
20	14B079	Wiring harness – Seat control feed jumper
21	14B102	Wiring harness – Backup alarm jumper
22	14C719	Kit – Trailer lamp plug and wiring
23	14N139	Wiring harness – Heater blower motor
24	15A416	Wiring harness – Rear window heater



BUY IT NOW!
Click Here To Order



G100, G101, G102, G103, G105

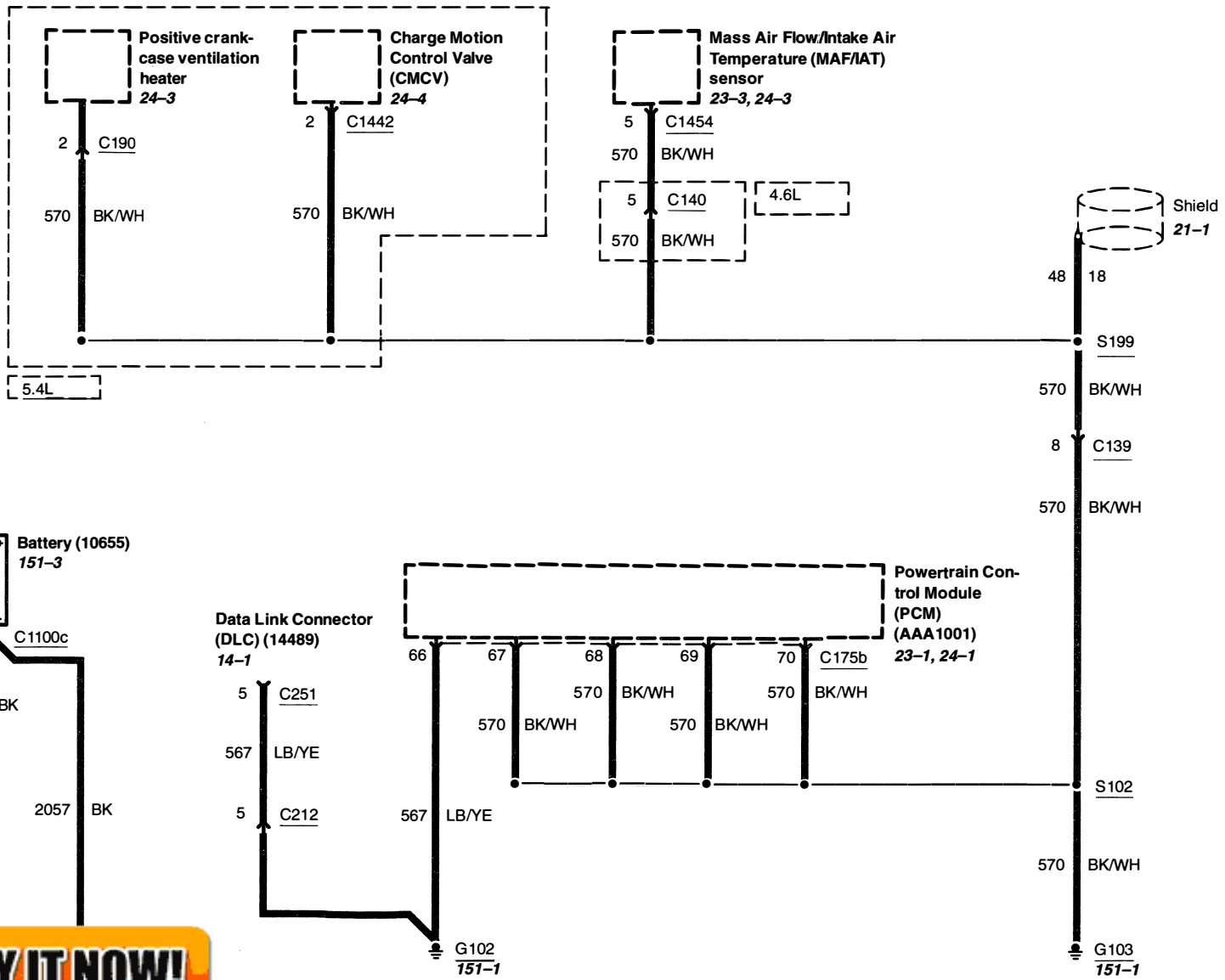

100% SATISFACTION GUARANTEED

BUY IT NOW!

Click Here To Order

G104, G108

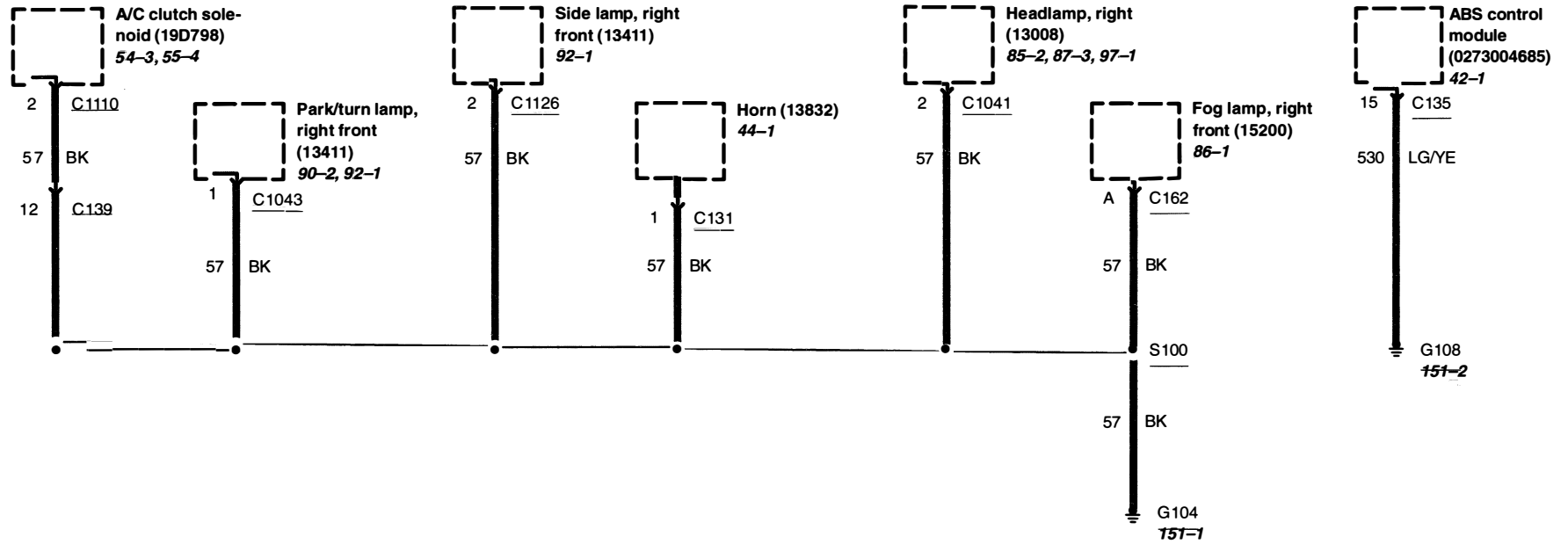

100% SATISFACTION GUARANTEED

BUY IT NOW!

Click Here To Order

G110

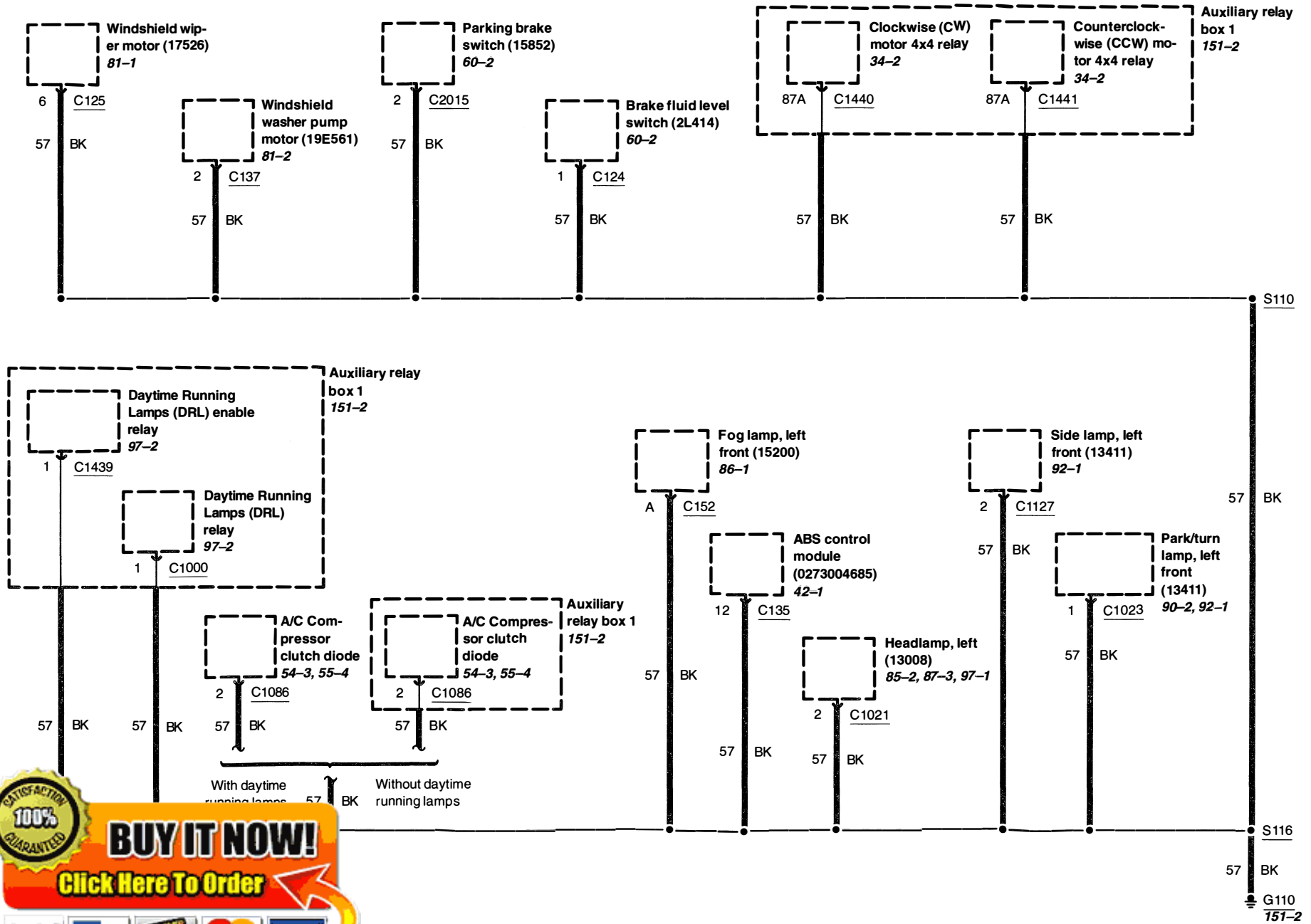

100% SATISFACTION GUARANTEED

BUY IT NOW!

Click Here To Order

G202

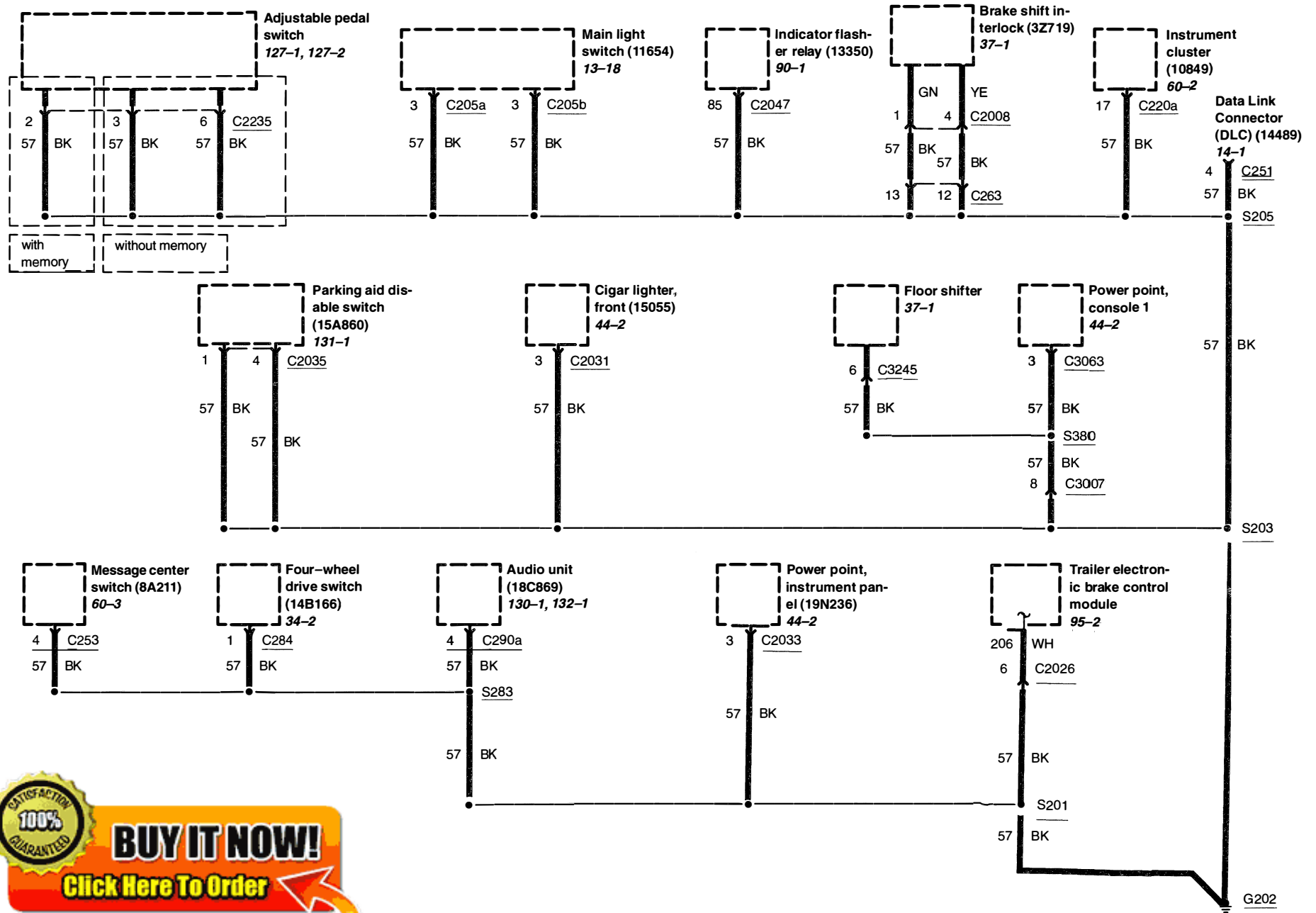

G202
151-12

100% SATISFACTORY GUARANTEED

BUY IT NOW!

Click Here To Order

G206

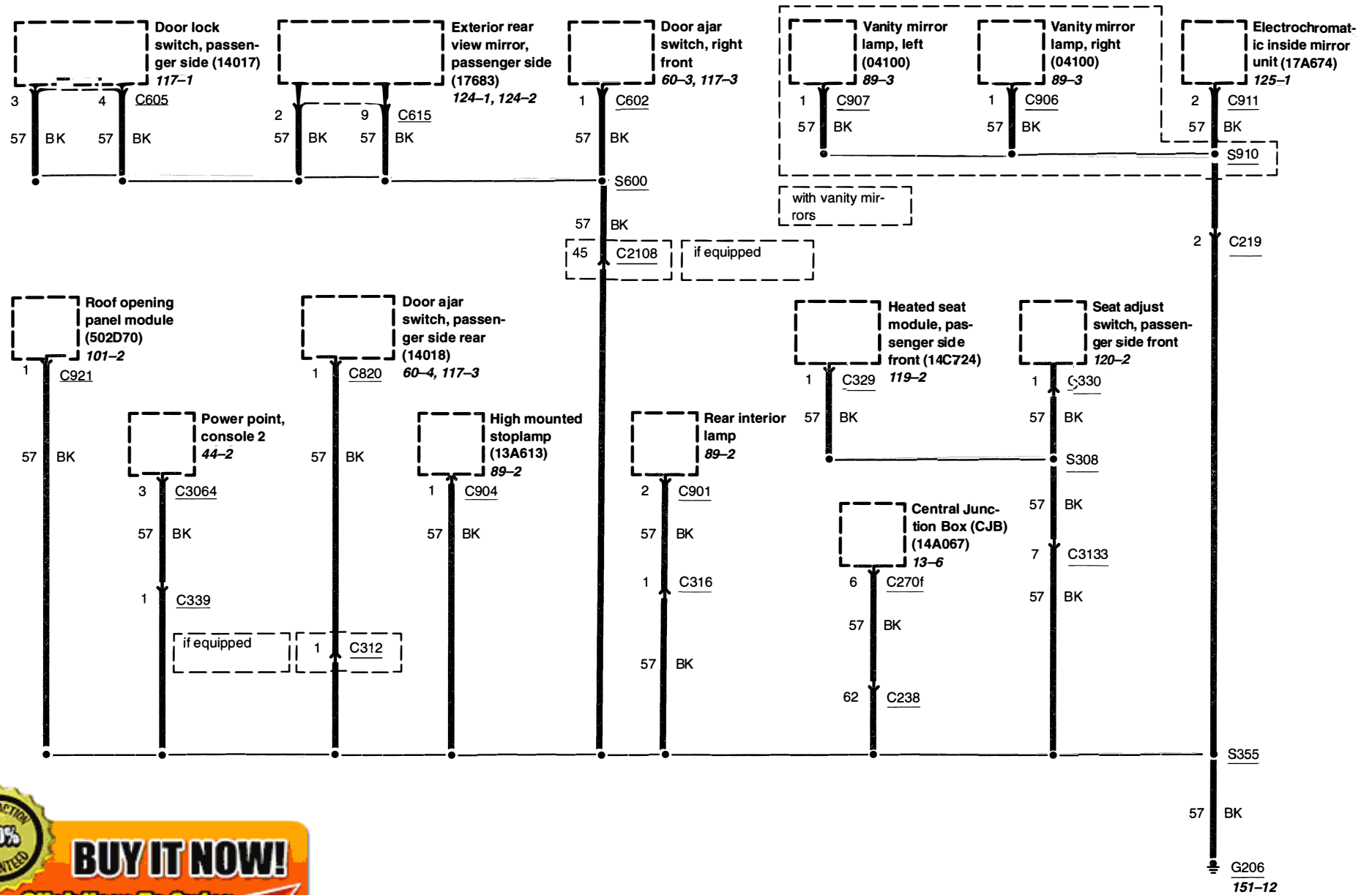

100% SATISFACTION GUARANTEED

BUY IT NOW!

Click Here To Order

PayPal, American Express Cards, Discover, MasterCard, VISA

G303, Regular cab

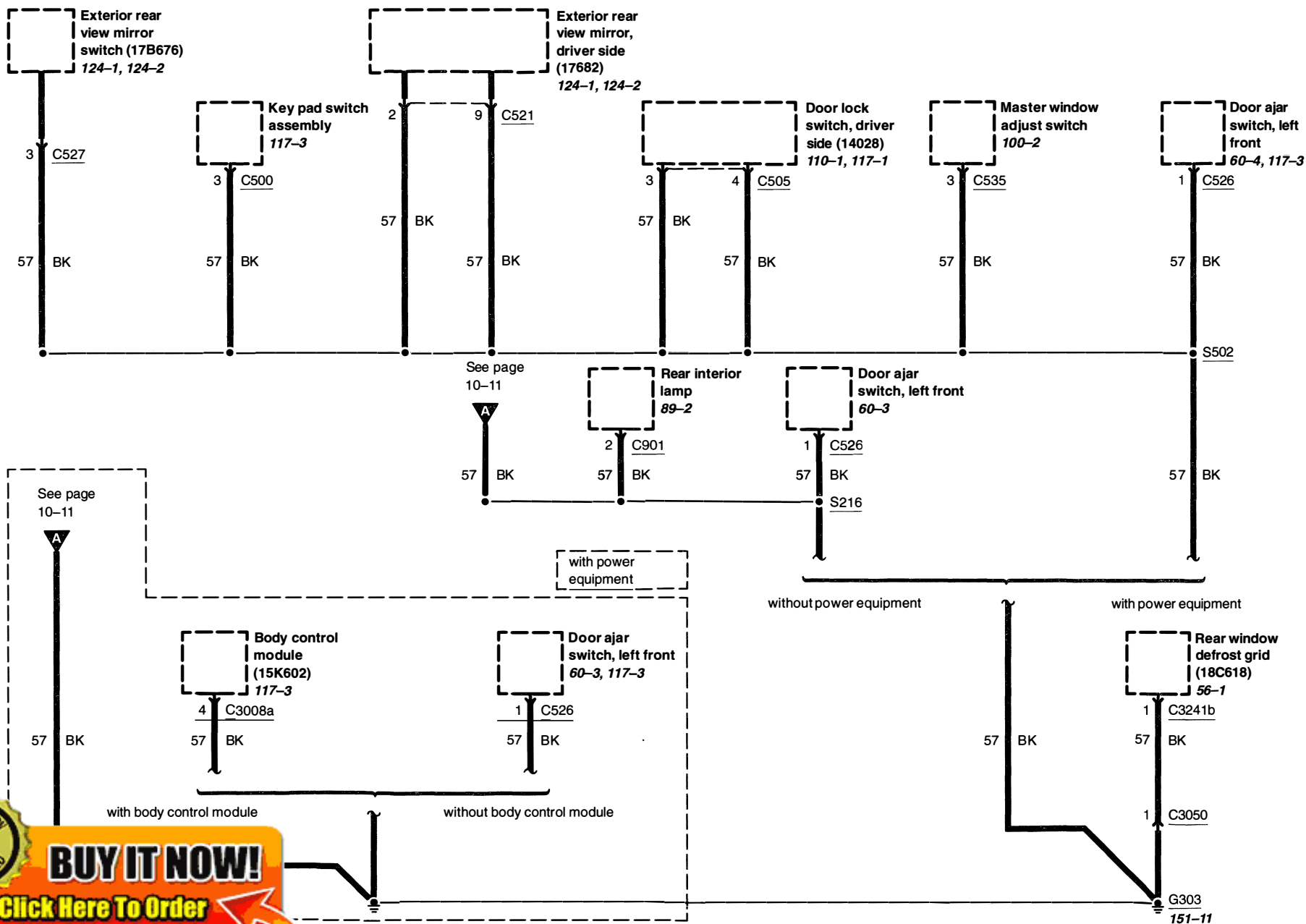

100% SATISFACTION GUARANTEED

BUY IT NOW!

Click Here To Order

PayPal American Express Discover MasterCard VISA

G303, Crew cab / Super cab

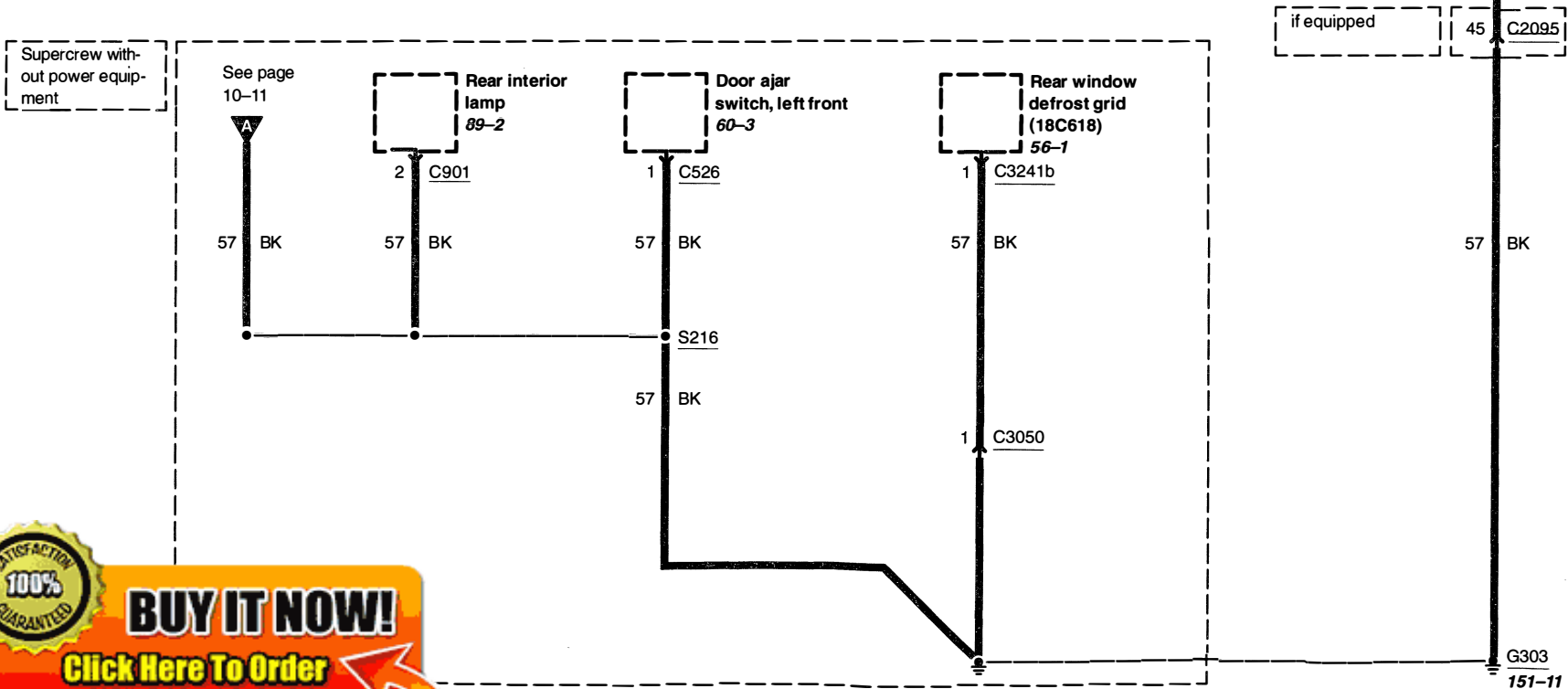
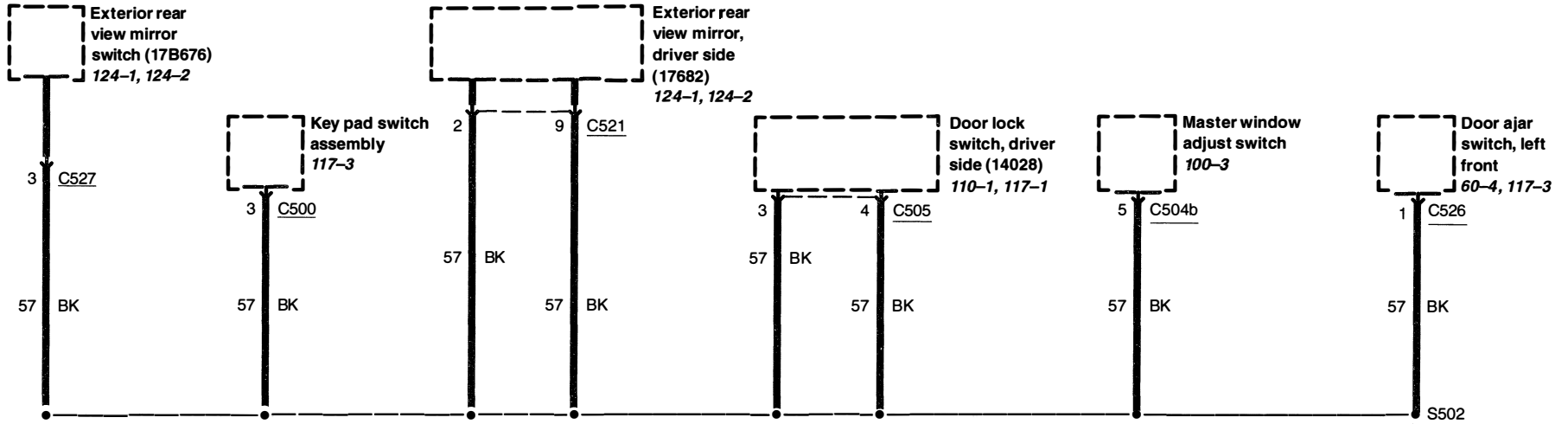

100% SATISFACTION GUARANTEED

BUY IT NOW!

Click Here To Order

G303, Crew cab / Super cab with power equipment

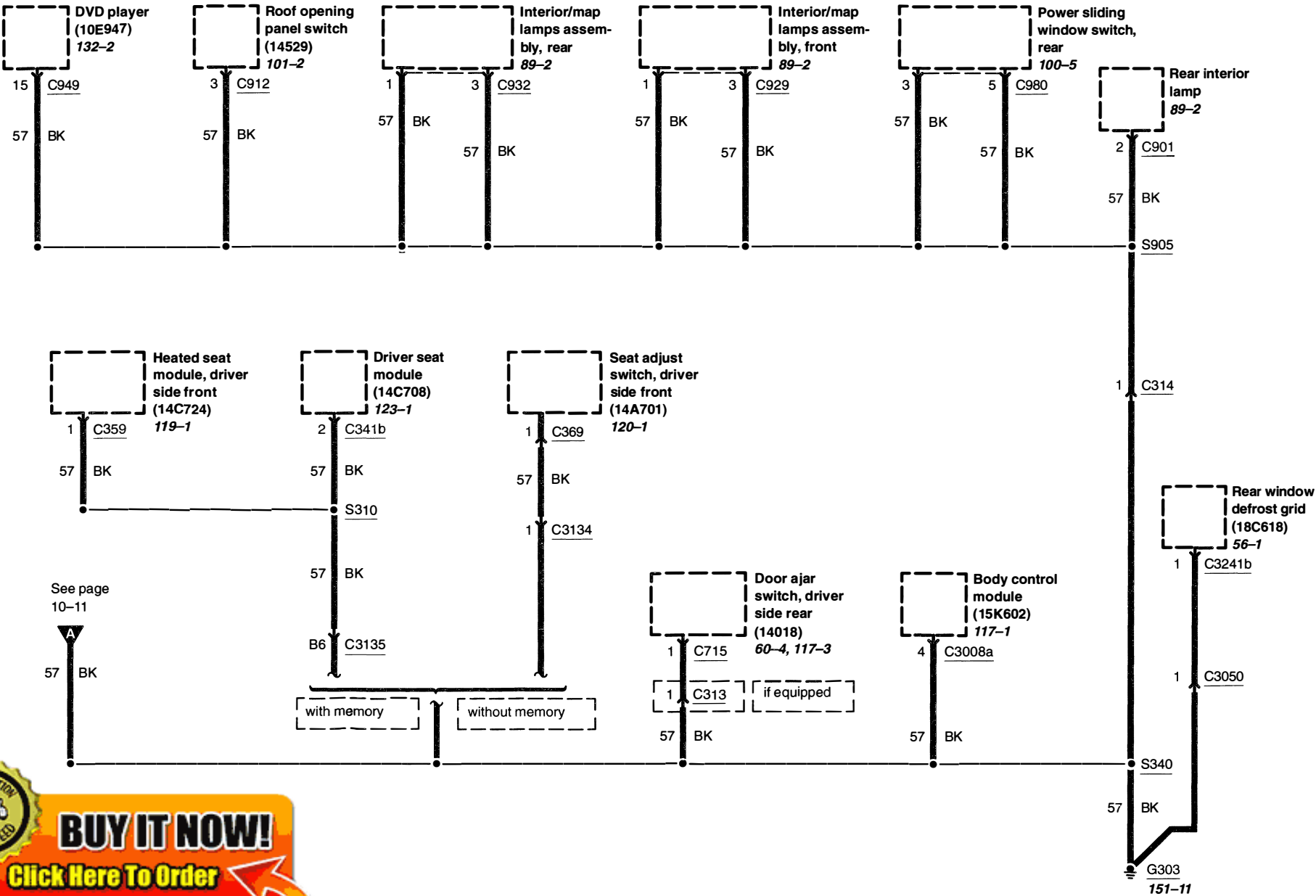

100% SATISFACTION GUARANTEED

BUY IT NOW!

Click Here To Order

G400, G401

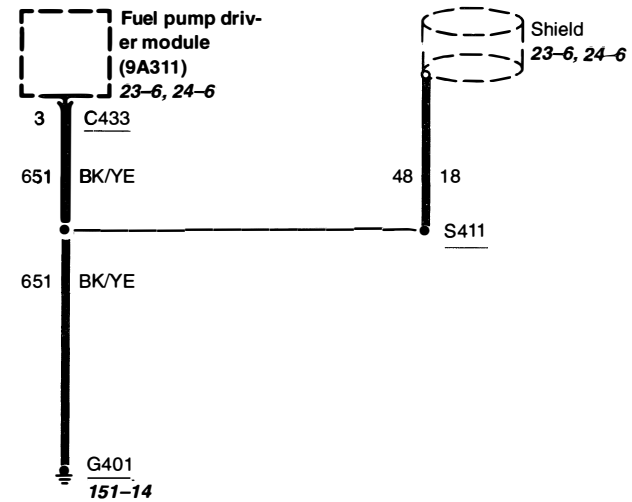
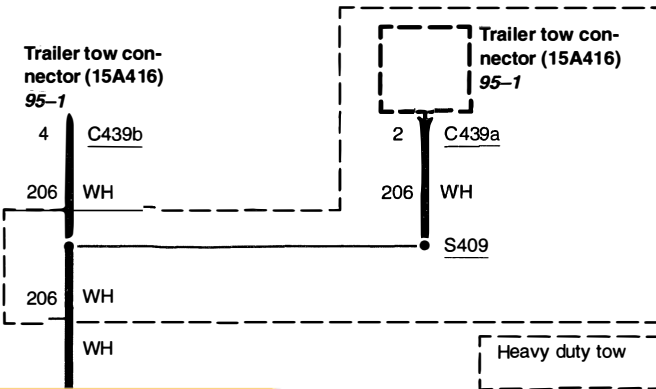
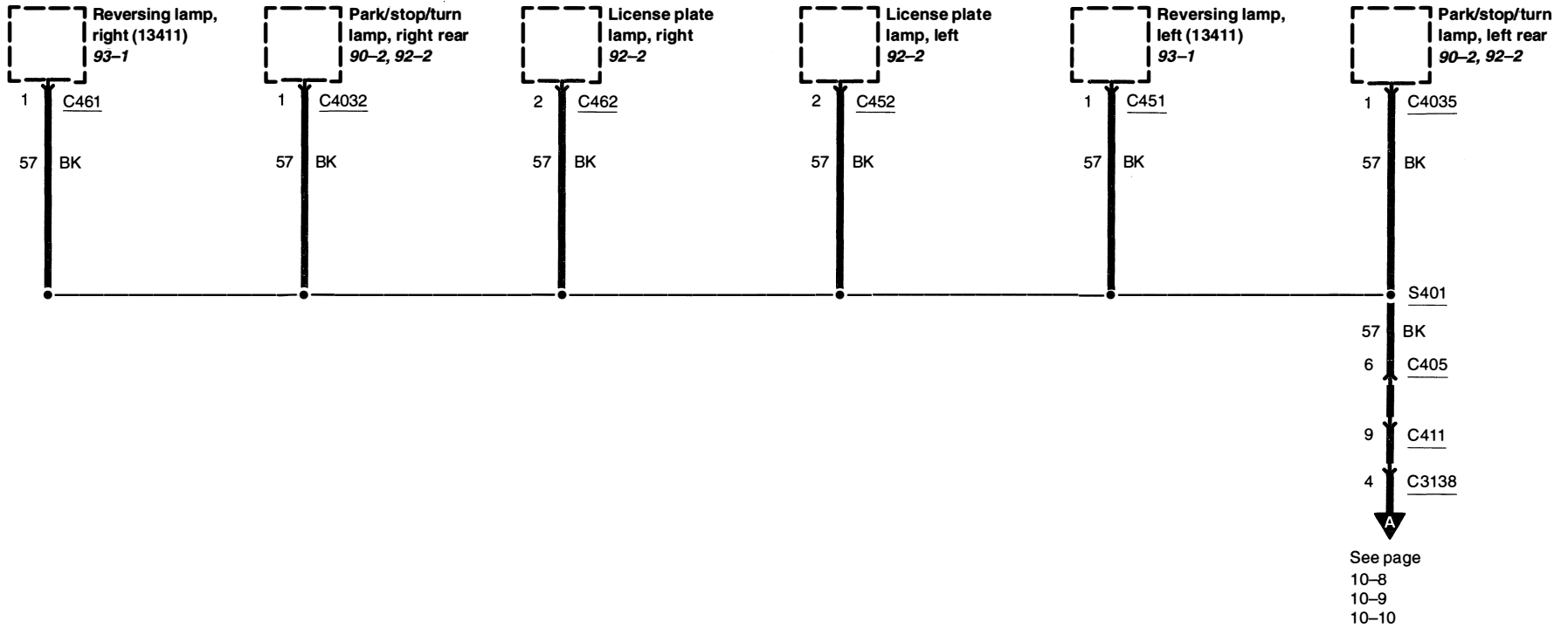

100% SATISFACTION GUARANTEED

BUY IT NOW!

Click Here To Order

PayPal, American Express, Discover, MasterCard, VISA

Central Junction Box (CJB) (14A067)

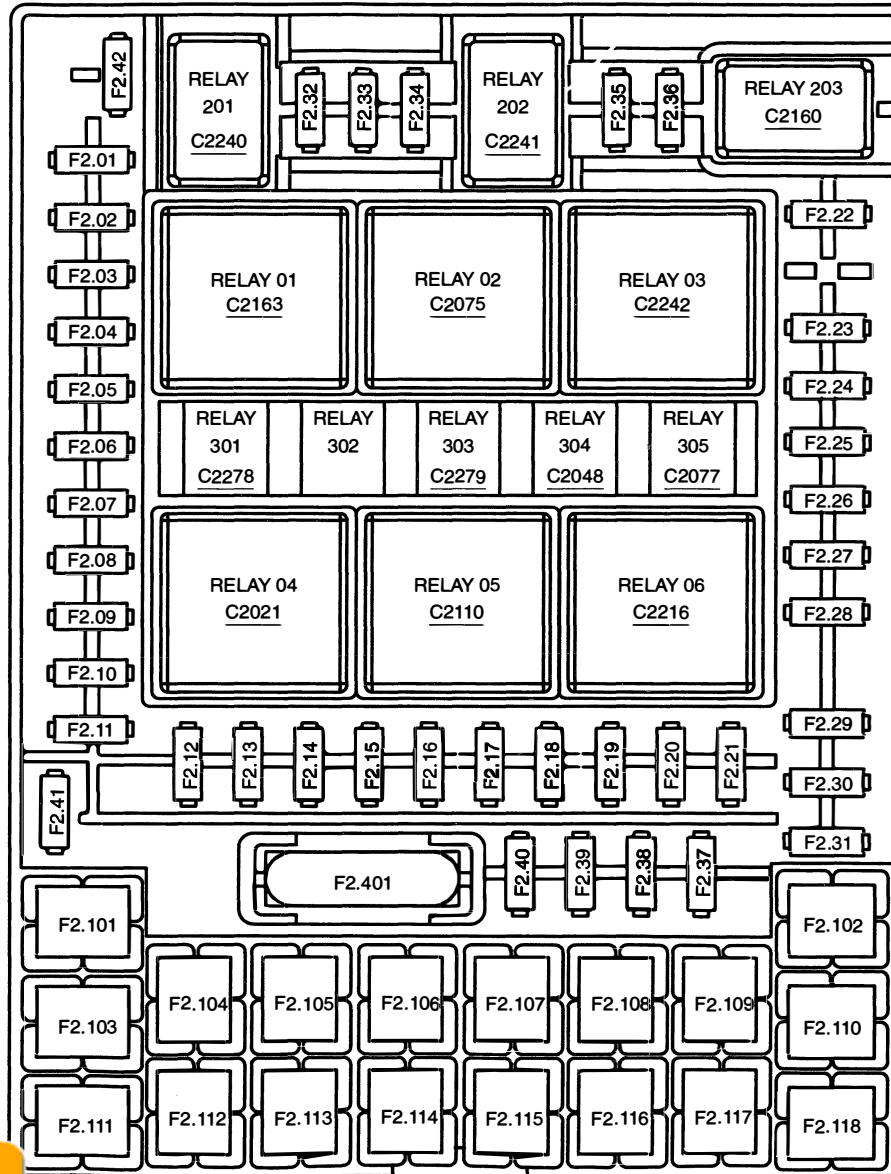

100% SATISFACTION GUARANTEED

BUY IT NOW!

Click Here To Order

PayPal, American Express, Discover, MasterCard, VISA

Central Junction Box (CJB) (14A067)

Fuse	Amps	Circuits protected
F2.01	10	Windshield wiper motor (17526), Instrument cluster (10849), Audio unit (18C869)
F2.02	20	Indicator flasher relay (13350), Brake pedal position switch (13480), Deactivator switch (9C872)
F2.03	5	Exterior rear view mirror switch (17B676), Seat adjust switch, driver side front (14A701), Driver seat module (14C708)
F2.04	10	DVD player (10E947)
F2.05	7.5	Powertrain Control Module (PCM) (AAA1001), Autolamp/sunload sensor (14A597), Electronic Manual Temperature Control (EMTC) module (19980), Electronic Automatic Temperature Control (EATC) module (19980)
F2.06	15	Main light switch (11654), Body control module (15K602)
F2.07	5	Audio unit (18C869), Digital Transmission Range (DTR) sensor (7F293)
F2.08	10	Electronic Manual Temperature Control (EMTC) module (19980), Electronic Automatic Temperature Control (EATC) module (19980), Exterior rear view mirror, driver side (17682), Exterior rear view mirror, passenger side (17683)
F2.10	20	Trailer tow relay, parking lamp, Trailer tow relay, reversing lamp
F2.11	10	A/C clutch relay, 4x4 center axle disconnect solenoid
F2.13	10	Electronic Manual Temperature Control (EMTC) module (19980), Electronic Automatic Temperature Control (EATC) module (19980)
F2.14	10	Digital Transmission Range (DTR) sensor (7F293), Daytime Running Lamps (DRL) enable relay, Brake pedal position switch (13480), A/C high pressure switch (19D594), Positive crankcase ventilation heater
F2.15	5	Floor shifter, Overdrive cancel switch (7G550), Instrument cluster (10849)
F2.16	10	ABS control module (0273004685), Deactivator switch (9C872)
F2.17	15	Fog lamp relay
F2.18	10	Indicator flasher relay (13350), Parking Aid Module (PAM) (15K850), Electronic compass (19A548), Electrochromatic inside mirror unit (17A674), Heated seat module, driver side front (14C724), Heated seat module, passenger side front (14C724), Body control module (15K602)
F2.19	10	Passenger Air bag Deactivation (PAD) switch (14B268), Seat weight sensor module (603B02), Restraints control module (14B321)
F2.20	15	Powertrain Control Module (PCM) (AAA1001)
F2.21	10	Instrument cluster (10849)
F2.22	10	Roof opening panel switch (14529), Door lock switch, driver side (14017), Door lock switch, driver side (14028)
F2.23	10	Headlamp, left (13008)

Fuse	Amps	Circuits protected
F2.24	15	Battery saver relay
F2.25	10	Headlamp, left (13008)
F2.26	20	Horn relay
F2.27	5	Passenger Air bag Deactivation (PAD) indicator (14B418), Instrument cluster (10849)
F2.28	5	PCM power diode, Passive anti-theft transceiver module (15607)
F2.29	15	Powertrain Control Module (PCM) (AAA1001)
F2.31	20	Audio unit (18C869)
F2.32	15	Evaporative emission (EVAP) canister vent valve (9F945), A/C clutch relay, Charge Motion Control Valve (CMCV), Valve cover assembly, right, Valve cover assembly, left, Heated Oxygen Sensor (HO2S) #11 (9F472), Heated Oxygen Sensor (HO2S) #21 (9F472), Manifold Absolute Pressure/Intake Air Temperature (MAP/IAT) sensor, Positive crankcase ventilation heater, Intake Manifold Runner Control (IMRC) module, EGR system module
F2.33	15	4R70E/4R75E Transmission, Heated Oxygen Sensor (HO2S) #12 (9G444), Heated Oxygen Sensor (HO2S) #22 (9G444)
F2.34	20	Fuel pump relay, Powertrain Control Module (PCM) (AAA1001), Fuel injector 1 (9F593), Fuel injector 2 (9F593), Fuel injector 3 (9F593), Fuel injector 4 (9F593), Fuel injector 5 (9F593), Fuel injector 6 (9F593), Fuel injector 7 (9F593), Fuel injector 8 (9F593)
F2.35	20	Fog lamp relay, Daytime Running Lamps (DRL) relay, Headlamp, right (13008), Headlamp, left (13008), Instrument cluster (10849), Fog lamp, left front (15200), Fog lamp, right front (15200), Main light switch (11654)
F2.36	10	Trailer tow connector (15A416), Park/stop/turn lamp, right rear
F2.37	20	Power point, console 1, Power point, console 2
F2.38	25	Subwoofer (18C808)
F2.39	20	Power point, instrument panel (19N236)
F2.40	20	Daytime Running Lamps (DRL) enable relay, Body control module (15K602), Main light switch (11654), Multifunction switch (13K359)
F2.41	20	Data Link Connector (DLC) (14489), Cigar lighter, front (15055)
F2.42	10	Trailer tow connector (15A416), Park/stop/turn lamp, left rear
F2.101	30	Starter relay (11450)
F2.102	20	Ignition switch (11572)
F2.103	20	ABS control module (0273004685)
F2.105	30	Trailer electronic brake control module
F2.106	30	Trailer tow relay, battery charge

100% SATISFACTION GUARANTEED

BUY IT NOW!

Click Here To Order

PayPal American Express Discover MasterCard VISA

Central Junction Box (CJB) (14A067)

Fuse	Amps	Circuits protected
F2.107	30	Body control module (15K602)
F2.108	30	Seat adjust switch, passenger side front
F2.109	30	Adjustable pedal switch, Seat adjust switch, driver side front (14A701), Driver seat module (14C708)
F2.111	30	Clockwise (CW) motor 4x4 relay, Counterclockwise (CCW) motor 4x4 relay
F2.112	40	ABS control module (0273004685)
F2.113	30	Windshield wiper motor (17526)
F2.114	40	Rear window defrost relay
F2.116	30	Front blower motor relay
F2.118	30	Heated seat module, driver side front (14C724), Heated seat module, passenger side front (14C724)
F2.401	30 CB	Power sliding window switch, rear, Roof opening panel module (502D70), Master window adjust switch, Window adjust switch, passenger side (14529A)

Relay #	Connector #	Name
01	C2163	Starter relay (11450)
02	C2075	Accessory delay relay
03	C2242	High beam relay
04	C2021	Rear window defrost relay
05	C2110	Trailer tow relay, battery charge
06	C2216	Front blower motor relay
201	C2240	Trailer tow relay, parking lamp
202	C2241	Fog lamp relay
203	C2160	PCM power relay
301	C2278	Trailer tow relay, reversing lamp
302	-	not used
303	C2279	Fuel pump relay
304	C2048	Battery saver relay
305	C2077	Horn relay



BUY IT NOW!
Click Here To Order 







Auxiliary relay box 1

without daytime running lamps

with daytime running lamps

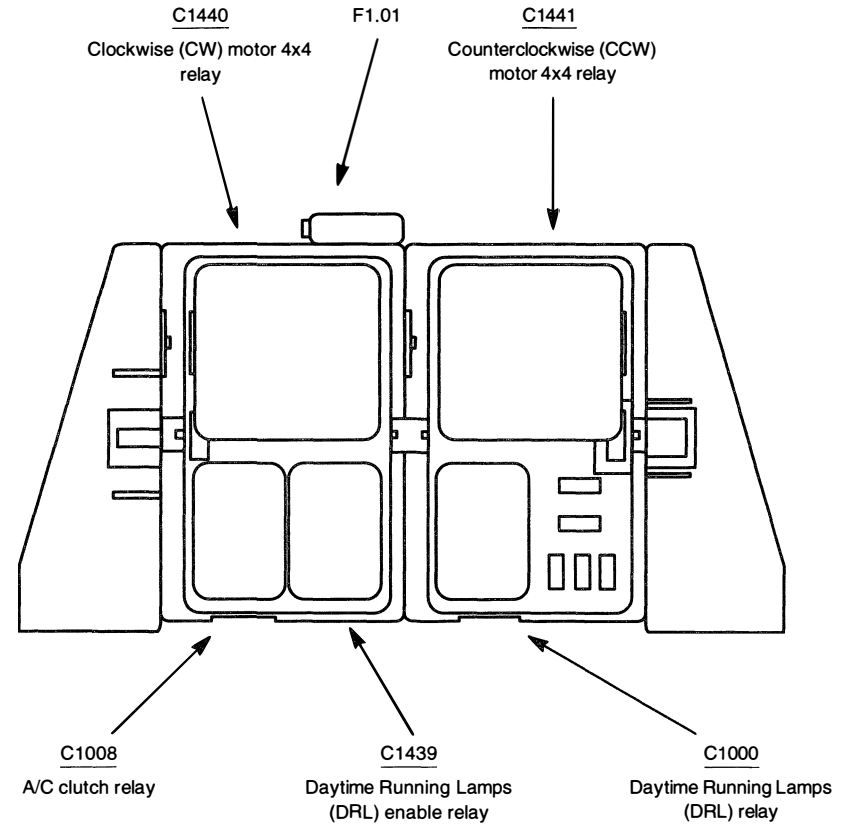
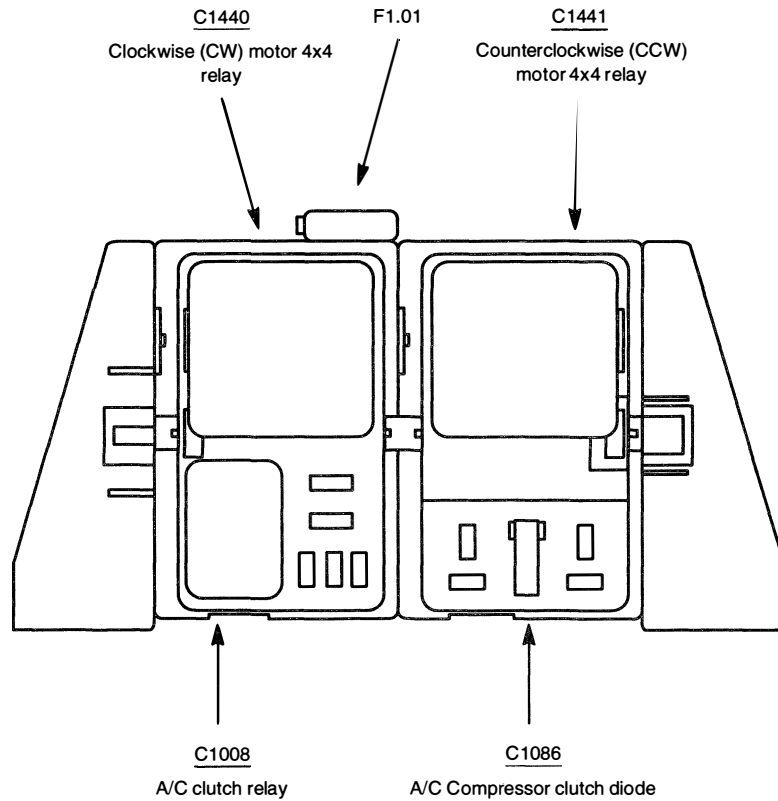

Fuse	Amps	Circuits protected
F1.01	5	Air bag sliding contact (14A664)

100% SATISFACTION GUARANTEED

BUY IT NOW!

Click Here To Order

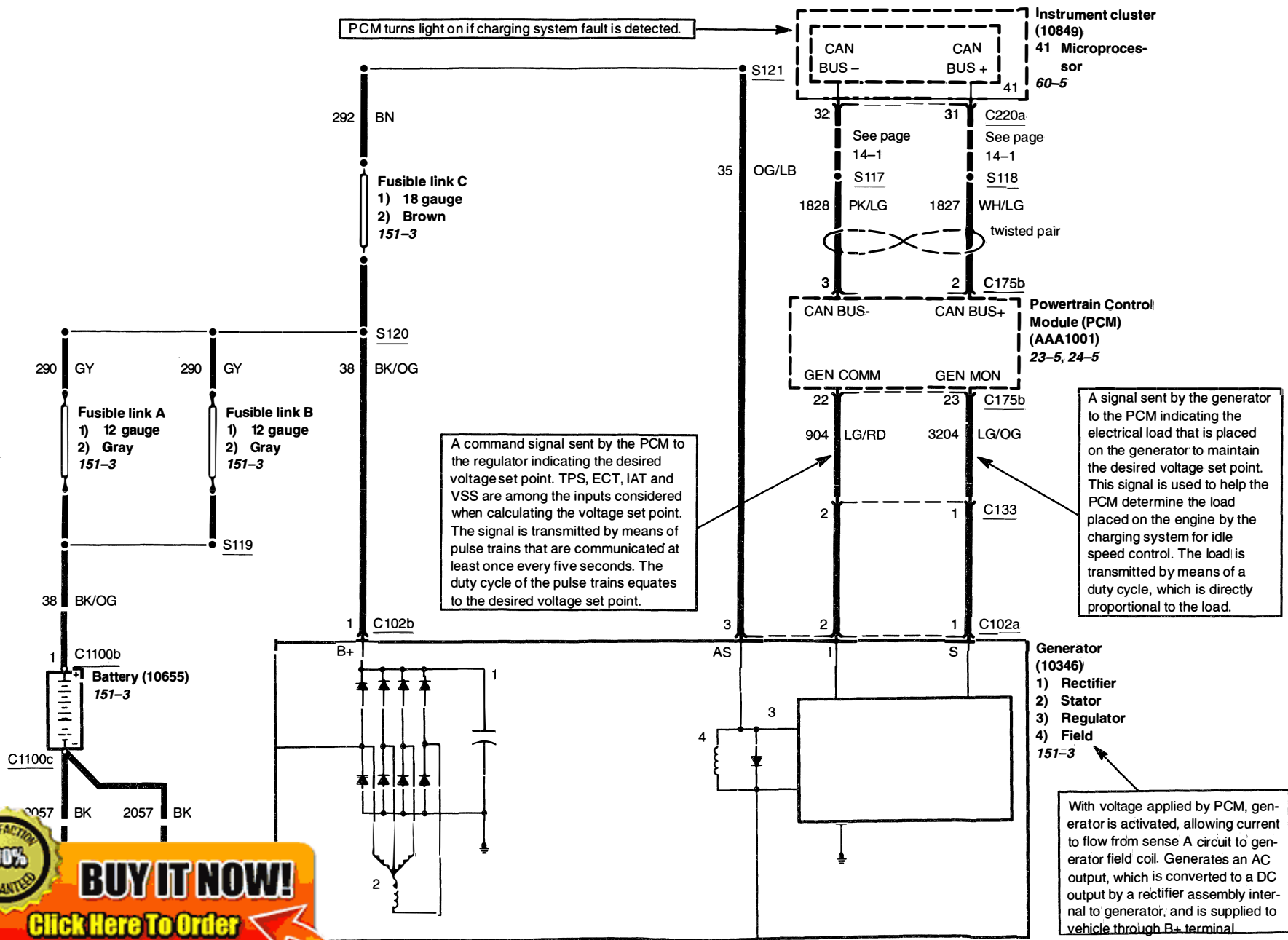

100% SATISFACTION GUARANTEED

BUY IT NOW!

Click Here To Order

C603 (GY)

14A005/14630

Door lock actuator, right front

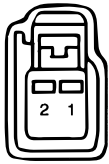

FEMALE

Pin	Circuit	Circuit function
1	117 (PK/BK)	Door lock actuator, right front +/-
2	118 (PK/OG)	Door lock actuator, right front +/-

C605 (GN)

14A005/14630

Door lock switch, passenger side (14017)

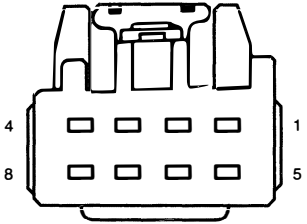

FEMALE

Pin	Circuit	Circuit function
1	-	not used
2	119 (PK/YE)	Lock, switch sense
3	57 (BK)	Ground
4	57 (BK)	Ground
5	54 (LG/YE)	Accessory delay relay switched power
6	120 (PK/LG)	Unlock, switch sense
7	-	not used
8	-	not used

C604 (BU)

* Regular cab

14A005/14630

Window adjust switch, passenger side (14529A)

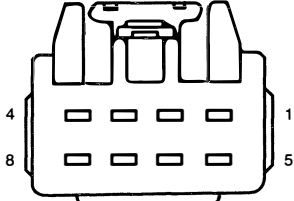

FEMALE

Pin	Circuit	Circuit function
1	-	not used
2	334 (RD/YE)	Power window motor, passenger side front Up switch sense
3	314 (TN/LB)	Passenger front window circuit - Up switch sense
4	193 (YE/LG)	Window lockout feed
	*400 (LB/BK)	Accessory delay relay switched power
5	313 (WH/YE)	Passenger front window circuit - Down switch sense
6	333 (YE/RD)	Power window motor, passenger side front Down switch sense

C608 (BK)

14A005/14630

Power window motor, passenger side front (1523200)

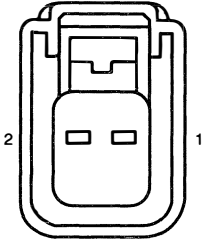

FEMALE

Pin	Circuit	Circuit function
1	333 (YE/RD)	Power window motor, passenger side front +/-
2	334 (RD/YE)	Power window motor, passenger side front +/-

100% SATISFACTION GUARANTEED

BUY IT NOW!

Click Here To Order

C612 (BK)

14A005/14630

Speaker, right front
(18808)

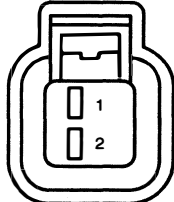

FEMALE

Pin	Circuit	Circuit function
1	805 (WH/LG)	Speaker, right front +
2	811 (DG/OG)	Speaker, right front -

C701 (BU)

14A005/14633

Window adjust
switch, left rear
(14A412)

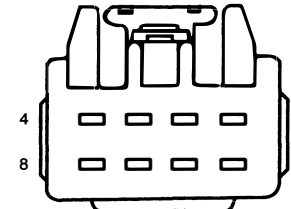

FEMALE

Pin	Circuit	Circuit function
1	-	not used
2	884 (YE/BK)	Power window motor, left rear Down switch sense
3	316 (YE/LB)	Left rear window circuit - Up switch sense
4	193 (YE/LG)	Window lockout feed
5	317 (GY/OG)	Left rear window circuit - Down switch sense
6	885 (YE/LB)	Power window motor, left rear Up switch sense
7	-	not used
8	-	not used

C615 (BK)

14A005/14630

Exterior rear view
mirror, passenger
side (17683)

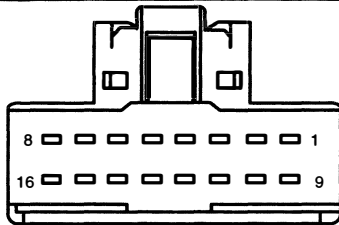

FEMALE

Pin	Circuit	Circuit function
1	59 (DG/VT)	Rear window defrost relay switched power
2	57 (BK)	Ground
3	542 (YE)	Up/Down mirror movement, motor +/-
4	544 (VT)	Up/Down mirror movement, motor +/-
5	543 (DG)	Right/Left mirror movement, motor +/-
6	542 (YE)	Right/Left mirror movement, motor +/-
7	-	not used
8	-	not used
9	57 (BK)	Ground
10	2 (WH/LB)	right front Turn lamps signal feed
11	-	not used
12	-	not used
13	-	not used
14	-	not used
15	-	not used
16	-	not used

C702 (BK)

14A005/14633

Speaker, left rear
(18808)

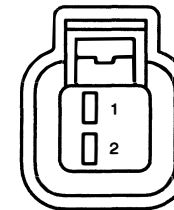

FEMALE

* Regular cab

Pin	Circuit	Circuit function
1	*1734 (LG/BK)	Speaker, left rear +
	800 (GY/LB)	Speaker, left rear +
2	*1733 (WH)	Speaker, left rear -
	801 (TN/YE)	Speaker, left rear -

100% SATISFACTION GUARANTEED

BUY IT NOW!

Click Here To Order

C703 (GY)

14A005/14633

Power window motor, left rear (1627001)

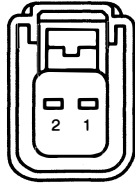

FEMALE

Super cab

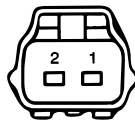

FEMALE

Pin	Circuit	Circuit function
1	885 (YE/LB)	Power window motor, left rear +/-
2	884 (YE/BK)	Power window motor, left rear +/-

C704 (GY)

14A005

Door lock actuator, left rear (218A43)

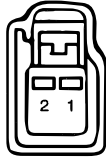

FEMALE

Pin	Circuit	Circuit function
1	117 (PK/BK)	Door lock actuator, left rear +/-
2	118 (PK/OG)	Door lock actuator, left rear +/-

C715 (BK)

14A005

Door ajar switch, driver side rear (14018)

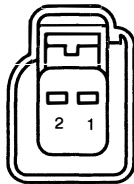

FEMALE

Pin	Circuit	Circuit function
1		
2		Door ajar switch, driver side rear switch sense

C801 (BU)

14A005/14632

Window adjust switch, right rear (14A412)

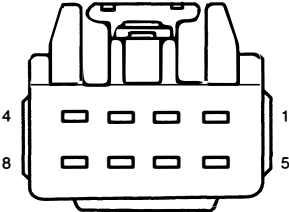

FEMALE

Pin	Circuit	Circuit function
1	-	not used
2	882 (BN/YE)	Power window motor, right rear Up switch sense
3	320 (RD/BK)	Right rear window circuit - Up switch sense
4	193 (YE/LG)	Window lockout feed
5	319 (YE/BK)	Right rear window circuit - Down switch sense
6	881 (BN)	Power window motor, right rear Down switch sense
7	-	not used
8	-	not used

100% SATISFACTION GUARANTEED

BUY IT NOW!

Click Here To Order

C802 (BK)

* with DVD player

14A005/14632

Speaker, right rear
(18808)

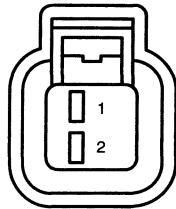

FEMALE

Pin	Circuit	Circuit function
1	*1789 (VT/WH)	Speaker, right rear +
	802 (OG/RD)	Speaker, right rear +
2	*1788 (YE/RD)	Speaker, right rear -
	803 (BN/PK)	Speaker, right rear -

C804 (GY)

14A005

Door lock actuator,
right rear (218A42)

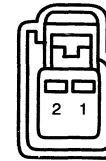

FEMALE

Pin	Circuit	Circuit function
1	117 (PK/BK)	Door lock actuator, right rear +/-
2	118 (PK/OG)	Door lock actuator, right rear +/-

C820 (BK)

14A005

Door ajar switch,
passenger side rear
(14018)

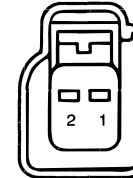

FEMALE

Pin	Circuit	Circuit function
1	57 (BK)	Ground
2	346 (BK/WH)	Door ajar switch, passenger side rear switch sense

C803 (GY)

14A005/14632

Power window mo-
tor, right rear
(1627000)

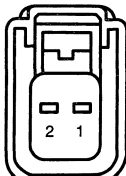

FEMALE

Super cab

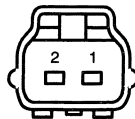

FEMALE

Pin	Circuit	Circuit function
1	117 (PK/BK)	Door lock actuator, right rear +/-
2	118 (PK/OG)	Door lock actuator, right rear +/-

C901 (WH)

14358

Rear interior lamp

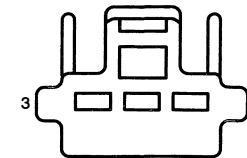

FEMALE

Pin	Circuit	Circuit function
1	53 (BK/LB)	Interior lamps switched power
2	57 (BK)	Ground
3	705 (LG/OG)	Battery saver relay switched power

100% SATISFACTION GUARANTEED

BUY IT NOW!

Click Here To Order

C904 (GY)
14A005

High mounted stop-lamp (13A613)

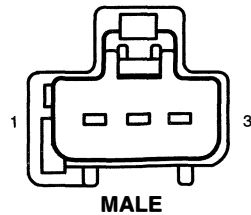

MALE

Pin	Circuit	Circuit function
1	57 (BK)	Ground
2	53 (BK/LB)	Interior lamps switched power
3	511 (LG)	Brake pedal position switch switched power

C909 (BK)
14334

Electronic compass (19A548)

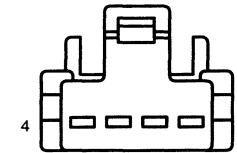

FEMALE

Pin	Circuit	Circuit function
1	703 (WH/OG)	Compass data +
2	702 (WH/BK)	Compass data -
3	294 (WH/LB)	Voltage supplied in Start and Run (overload protected)
4	875 (BK/LB)	Ground

C906 (BK)
14334

Vanity mirror lamp, right (04100)

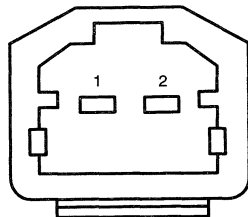

MALE

Pin	Circuit	Circuit function
1	57 (BK)	Ground
2	705 (LG/OG)	Battery saver relay switched power

C911 (BK)
14334

Electrochromatic inside mirror unit (17A674)

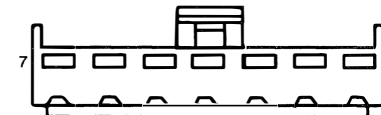

FEMALE

Pin	Circuit	Circuit function
1	294 (WH/LB)	Voltage supplied in Start and Run (overload protected)
2	57 (BK)	Ground
3	140 (BK/PK)	Trailer tow relay, reversing lamp switched power
4	-	not used
5	-	not used
6	-	not used
7	-	not used

C907 (BK)
14334

Vanity mirror lamp, left (04100)

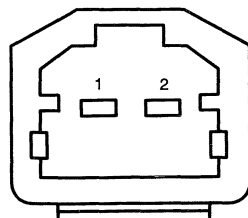

MALE

Pin	Circuit	Circuit function
1	57 (BK)	Ground
2	705 (LG/OG)	Battery saver relay switched power

100% SATISFACTION GUARANTEED

BUY IT NOW!

Click Here To Order

C912 (GN)

14358

Roof opening panel switch (14529)

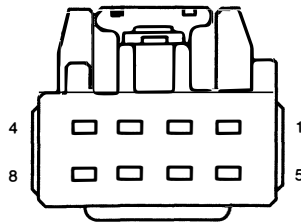

FEMALE

Pin	Circuit	Circuit function
1	-	not used
2	1174 (WH/RD)	Roof opening panel switch – Slide Close
3	57 (BK)	Ground
4	1173 (BN/OG)	Roof opening panel switch – common
5	54 (LG/YE)	Accessory delay relay switched power
6	1175 (TN/RD)	Roof opening panel switch – Slide Open
7	-	not used
8	-	not used

C921 (GY)

14A005

Roof opening panel module (502D70)

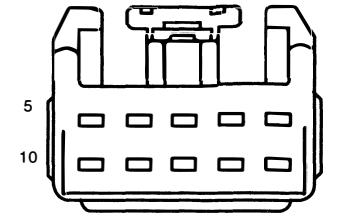

FEMALE

Pin	Circuit	Circuit function
1	57 (BK)	Ground
2	1173 (BN/OG)	Roof opening panel switch – common
3	400 (LB/BK)	Accessory delay relay switched power
4	-	not used
5	1175 (TN/RD)	Roof opening panel switch – Slide Open
6	400 (LB/BK)	Accessory delay relay switched power
7	-	not used
8	-	not used
9	-	not used
10	1174 (WH/RD)	Roof opening panel switch – Slide Close

C929 (WH)

14358

Interior/map lamps assembly, front

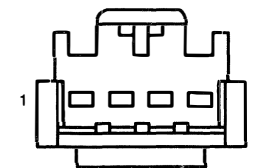

FEMALE

Pin	Circuit	Circuit function
1	57 (BK)	Ground
2	53 (BK/LB)	Interior lamps switched power
3	57 (BK)	Ground
4	705 (LG/OG)	Battery saver relay switched power

100% SATISFACTION GUARANTEED

BUY IT NOW!

Click Here To Order

C932

14358

Interior/map lamps assembly, rear

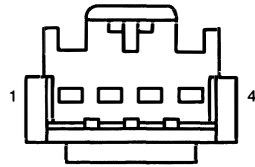

FEMALE

Pin	Circuit	Circuit function
1	57 (BK)	Ground
2	53 (BK/LB)	Interior lamps switched power
3	57 (BK)	Ground
4	705 (LG/OG)	Battery saver relay switched power

C949

14358

DVD player (10E947)

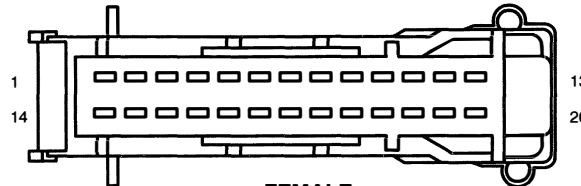

FEMALE

Pin	Circuit	Circuit function
1	720 (RD/YE)	Voltage supplied at all times (overload protected)
2	-	not used
3	1204 (BK/OG)	Ground
4	832 (LB/PK)	CAN Bus +
5	833 (TN)	CAN Bus -
6	-	not used
7	802 (OG/RD)	Speaker, right rear signal +
8	803 (BN/PK)	Speaker, right rear signal -
9	800 (GY/LB)	Speaker, left rear signal +
10	801 (TN/YE)	Speaker, left rear signal -
11	48 (BK)	Shield
12	-	Speaker Right signal +
13	-	Speaker Right signal -
14	-	Interior illumination, feed

Pin	Circuit	Circuit function
15	57 (BK)	Ground
16	-	not used
17	-	not used
18	1734 (LG/BK)	Speaker, left rear +
19	1733 (WH)	Speaker, left rear -
20	1789 (VT/WH)	Speaker, right rear +
21	1788 (YE/RD)	Speaker, right rear -
22	-	not used
23	-	not used
24	-	not used
25	856 (VT)	DVD player Left signal +
26	798 (LG/RD)	DVD player Left signal -

100% SATISFACTION GUARANTEED

BUY IT NOW!

Click Here To Order

C980

14358

Power sliding window switch, rear

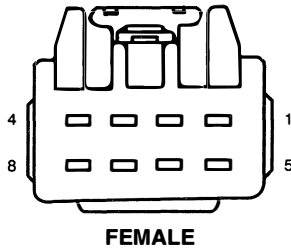

FEMALE

Pin	Circuit	Circuit function
1	-	not used
2	1941 (YE/LB)	Power sliding window motor, rear closed switch sense
3	57 (BK)	Ground
4	400 (LB/BK)	Accessory delay relay switched power
5	57 (BK)	Ground
6	1942 (RD/YE)	Power sliding window motor, rear Open switch sense
7	-	not used
8	-	not used

C1008

12A581

A/C clutch relay

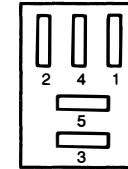

FEMALE

Pin	Circuit	Circuit function
1	391 (RD/YE)	PCM power relay switched power
2	331 (PK/YE)	A/C clutch relay control
3	883 (PK/LB)	Voltage supplied at all times (overload protected)
4	-	not used
5	321 (GY/WH)	A/C clutch relay switched power

C1021 (GN)

12A581

Headlamp, left (13008)

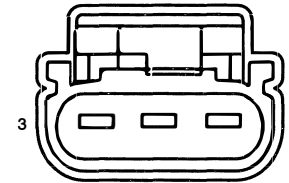

FEMALE

Pin	Circuit	Circuit function
1	160 (DB/WH)	Headlamps Low beam switched power
2	57 (BK)	Ground
3	12 (LG/BK)	High beam relay switched power

C1000

12A581

Daytime Running Lamps (DRL) relay

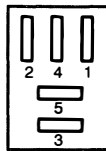

FEMALE

Pin	Circuit	Circuit function
1	57 (BK)	Ground
2	12 (LG/BK)	High beam relay switched power
3	57 (BK)	Ground
4	12 (LG/BK)	High beam relay switched power
5	57 (BK)	Ground

100% SATISFACTION GUARANTEED

BUY IT NOW!

Click Here To Order

C1023 (BN)

12A581

Park/turn lamp, left front (13411)

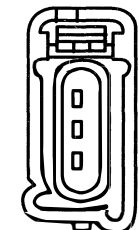

FEMALE

Pin	Circuit	Circuit function
1	57 (BK)	Ground
2	14 (BN)	Hot in Park or Head
3	3 (LG/WH)	left front Turn lamps signal feed

C1033 (BK)

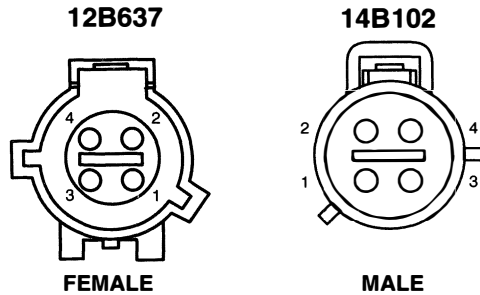

- (1) - (2) 1102 (YE/LG) (3) 359 (GY/RD) (4) -

C1068 (BK)

12B637

EGR system module

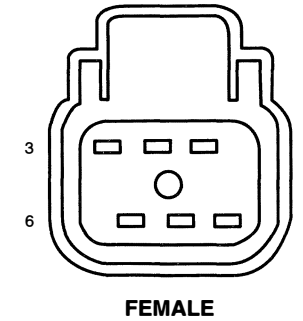

FEMALE

C1041 (GN)

12A581

Headlamp, right (13008)

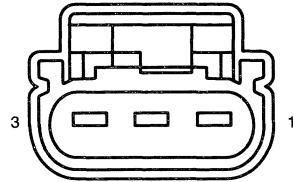

FEMALE

Pin	Circuit	Circuit function
1	161 (DG/OG)	Headlamps Low beam switched power
2	57 (BK)	Ground
3	12 (LG/BK)	High beam relay switched power

Pin	Circuit	Circuit function
1	360 (BN/PK)	EGR Vacuum Regulator (EVR) control
2	351 (BN/WH)	Reference voltage
3	3066 (OG/YE)	Manifold Absolute Pressure (MAP) sensor, input
4	391 (RD/YE)	PCM power relay switched power
5	352 (BN/LG)	Differential Pressure Feedback EGR (DPFE) sensor, input
6	359 (GY/RD)	Signal return

C1043 (BR)

12A581

Park/turn lamp, right front (13411)

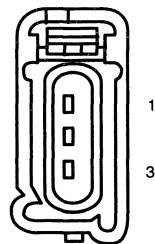

FEMALE

Pin	Circuit	Circuit function
1		Turn signal feed
2		Turn signal feed
3		Turn signal feed

C1078 (BK)

12A581

A/C high pressure switch (19D594)

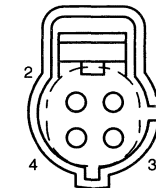

FEMALE

Pin	Circuit	Circuit function
1	295 (LB/PK)	Voltage supplied in Start and Run (overload protected)
2	-	not used
3	441 (RD/YE)	A/C high pressure switch signal
4	-	not used

100% SATISFACTION GUARANTEED

BUY IT NOW!

Click Here To Order

C1086 (BK)

12A581

A/C Compressor
clutch diode

Without daytime running
lamps

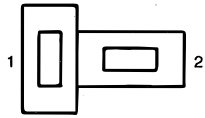

FEMALE

With daytime running
lamps

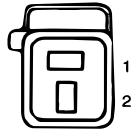

FEMALE

Pin	Circuit	Circuit function
1	321 (GY/WH)	A/C clutch relay switched power
2	57 (BK)	Ground

C1100c

14B060

Battery (10655)



Pin	Circuit	Circuit function
1	2057 (BK)	Ground
	2057 (BK)	Ground

C1100a

14B060

Battery (10655)

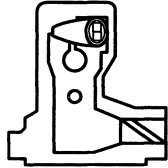

Pin	Circuit	Circuit function
1	2037 (RD)	Battery cable +

C1100d

14300

Battery (10655)

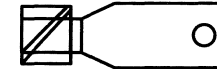

Pin	Circuit	Circuit function
1	1119 (RD)	Battery cable +

C1100b

14305

Battery (10655)

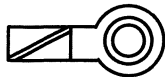

C1110 (BK)

12B637

A/C clutch solenoid
(19D798)

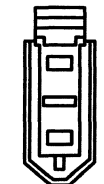

FEMALE

Pin	Circuit	Circuit function
1	321 (GY/WH)	A/C clutch relay switched power
2	57 (BK)	Ground

100% SATISFACTION GUARANTEED

BUY IT NOW!

Click Here To Order

C1126 (BK)

12A581

Side lamp, right front (13411)

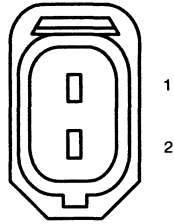

FEMALE

Pin	Circuit	Circuit function
1	14 (BN)	Hot in Park or Head
2	57 (BK)	Ground

C1277 (BK)

15525

Transfer case speed sensor

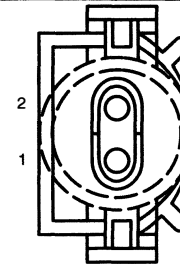

FEMALE

Pin	Circuit	Circuit function
1	359 (GY/RD)	Signal return
2	1504 (RD/WH)	Transfer case speed sensor signal

C1127 (BK)

12A581

Side lamp, left front (13411)

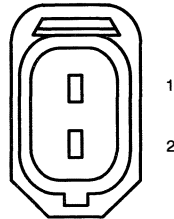

FEMALE

Pin	Circuit	Circuit function
1	14 (BN)	Hot in Park or Head
2	57 (BK)	Ground

C1291 (BK)

12A581

4x4 center axle disconnect solenoid

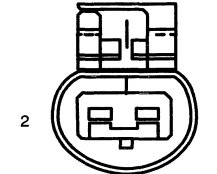

FEMALE

Pin	Circuit	Circuit function
1	883 (PK/LB)	Voltage supplied at all times (overload protected)
2	605 (RD)	4x4 center axle disconnect solenoid control

C1177 (BK)

15525

4x4 High/Low indicator switch (7E440)

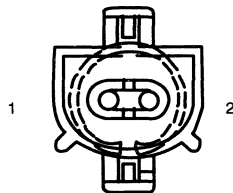

FEMALE

Pin	Circuit	Circuit function
1		drive indicator position 1
2		drive indicator position 2

C1303 (BK)

12B637

Fuel rail pressure transducer sensor (9F972)

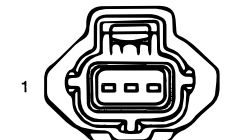

FEMALE

Pin	Circuit	Circuit function
1	351 (BN/WH)	Reference voltage
2	359 (GY/RD)	Signal return
3	1289 (OG/LG)	Fuel rail pressure transducer sensor signal

100% SATISFACTION GUARANTEED

BUY IT NOW!

Click Here To Order

C1311 (BK)

12B637

Power steering pressure sensor

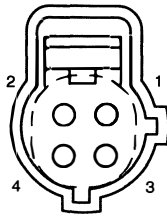

FEMALE

Pin	Circuit	FEMALE	Circuit function
1	359 (GY/RD)	Signal return	
2	351 (BN/WH)	Reference voltage	
3	336 (DG)	Power steering pressure sensor signal	
4	—	not used	

C1367 (BK)

12B637

Camshaft position sensor 2 (6B288)

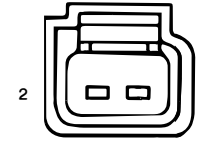

FEMALE

Pin	Circuit	Circuit function
1	359 (GY/RD)	Signal return
2	365 (OG)	Camshaft position sensor 2, signal

C1368 (BK)

12B637

Electronic Throttle Control (ETC) motor (9F991)

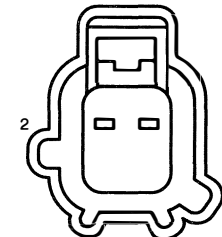

FEMALE

Pin	Circuit	Circuit function
1	1835 (DB/YE)	Electronic Throttle Control (ETC) motor +/-
2	1836 (OG/YE)	Electronic Throttle Control (ETC) motor +/-

C1366 (BK)

12B637

Camshaft position sensor 1 (6B288)



FEMALE

Circuit function
sensor 1, signal

100% SATISFACTION GUARANTEED

BUY IT NOW!

Click Here To Order

C1439

12A581

Daytime Running Lamps (DRL) enable relay

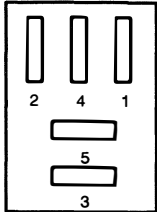

FEMALE

Pin	Circuit	Circuit function
1	57 (BK)	Ground
2	295 (LB/PK)	Voltage supplied in Start and Run (overload protected)
3	2017 (WH/RD)	Voltage supplied at all times (overload protected)
4	-	not used
5	1731 (RD/BK)	Daytime Running Lamps (DRL) enable relay switched power

C1440

12A581

Clockwise (CW) motor 4x4 relay

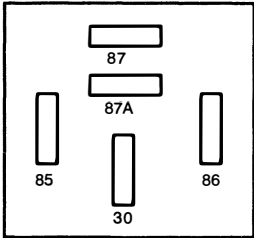

FEMALE

Pin	Circuit	Circuit function
30	786 (RD)	Clockwise (CW) motor 4x4 relay switched power
85	975 (BN/YE)	Clockwise (CW) motor 4x4 relay control
86	704 (DG/LG)	Voltage supplied at all times (overload protected)
87	704 (DG/LG)	Voltage supplied at all times (overload protected)
87A	57 (BK)	Ground

SATISFACTORY 100% GUARANTEED

BUY IT NOW!

Click Here To Order

C1441

12A581

Counterclockwise (CCW) motor 4x4 relay

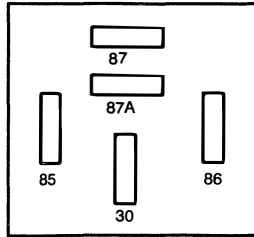

FEMALE

Pin	Circuit	Circuit function
30	785 (BK/LG)	Counterclockwise (CCW) motor 4x4 relay switched power
85	976 (OG)	Counterclockwise (CCW) motor 4x4 relay control
86	704 (DG/LG)	Voltage supplied at all times (overload protected)
87	704 (DG/LG)	Voltage supplied at all times (overload protected)
87A	57 (BK)	Ground

C1451 (BK)

12B637

Variable Camshaft Timing (VCT) valve 1 (6B297)

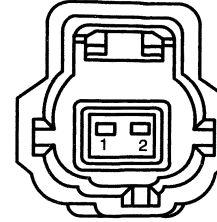

FEMALE

Pin	Circuit	Circuit function
1	391 (RD/YE)	PCM power relay switched power
2	642 (DG/OG)	Variable Camshaft Timing (VCT) valve 1 control

C1452 (BK)

12B637

Variable Camshaft Timing (VCT) valve 2 (6B297)

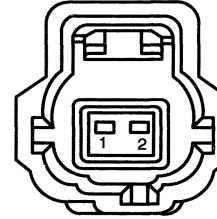

FEMALE

Pin	Circuit	Circuit function
1	391 (RD/YE)	PCM power relay switched power
2	641 (VT/LB)	Variable Camshaft Timing (VCT) valve 2 control

C1442 (BK)

12B637

Charge Motion Control Valve (CMCV)

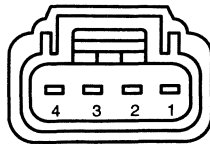

FEMALE

Pin	Circuit	Circuit function
	391 (RD/YE)	PCM power relay switched power
		Control Valve (CMCV) control
		Control Valve (CMCV) monitor

100% SATISFACTION GUARANTEED

BUY IT NOW!

Click Here To Order

C1454 (BK)

12A690-4.6L

12B637-5.4L

Mass Air Flow/Intake Air Temperature (MAF/IAT) sensor

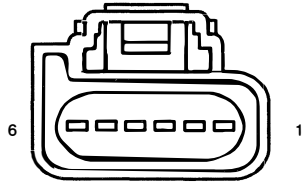

FEMALE

Pin	Circuit	Circuit function
1	743 (GY)	Intake Air Temperature (IAT) sensor, signal
2	359 (GY/RD)	Signal return
3	967 (LB/RD)	Mass Air Flow (MAF) sensor signal
4	968 (TN/LB)	Mass Air Flow (MAF) sensor, Signal return
5	570 (BK/WH)	Ground
6	391 (RD/YE)	PCM power relay switched power

C2003 (GY) * with memory

14A005

Adjustable pedal motor (2C429)

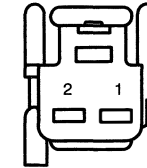

FEMALE

Pin	Circuit	Circuit function
1	1495 (WH)	Adjustable pedal motor, Forward +/-
	*1489 (LB/BK)	Adjustable pedal motor, Forward +/-
2	1494 (RD)	Adjustable pedal motor, Rearward +/-
	*1490 (LB/OG)	Adjustable pedal motor, Rearward +/-

C2004 (BK)

18B574

Front blower motor (19805)

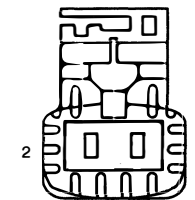

FEMALE

Pin	Circuit	Circuit function
1	399 (BN/YE)	Front blower motor relay switched power
2	755 (BN/WH)	Front blower motor control

100% SATISFACTION GUARANTEED

BUY IT NOW!

Click Here To Order

C2008 (GY)

14A320

Brake shift interlock
(3Z719)

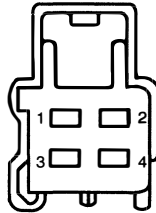

MALE

Pin	Circuit	Circuit function
1	57 (BK)	Ground
2	599 (PK/LG)	Brake pedal position switch, switched power
3	3410 (YE)	Key removal inhibit solenoid control
4	57 (BK)	Ground

C2021

14A067

Rear window defrost
relay

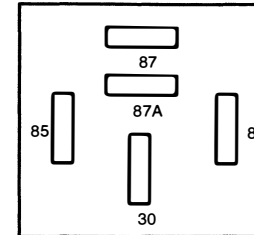

Pin	Circuit	Circuit function
30	-	Voltage supplied at all times (overload protected)
85	1009 (OG/YE)	Rear window defrost relay control
86	-	Voltage supplied in Start and Run (overload protected)
87	186 (BN/LB)	Rear window defrost relay switched power
87A	-	not used

C2015 (BK)

12A581

Parking brake
switch (15852)

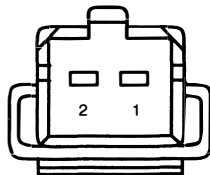

FEMALE

Circuit function
ch signal

100% SATISFACTION GUARANTEED

BUY IT NOW!

Click Here To Order

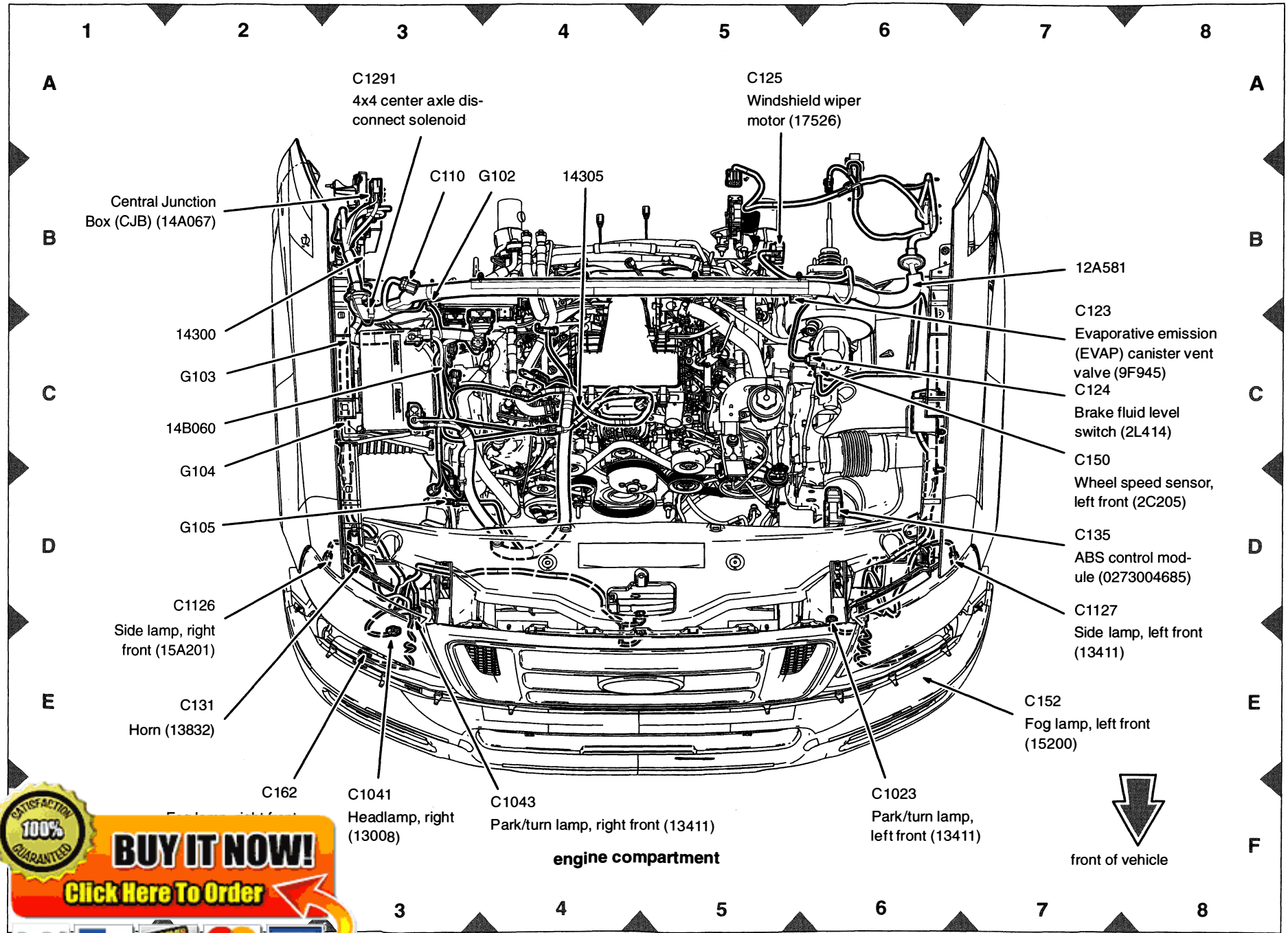

SATISFACTION 100% GUARANTEED

BUY IT NOW!

Click Here To Order

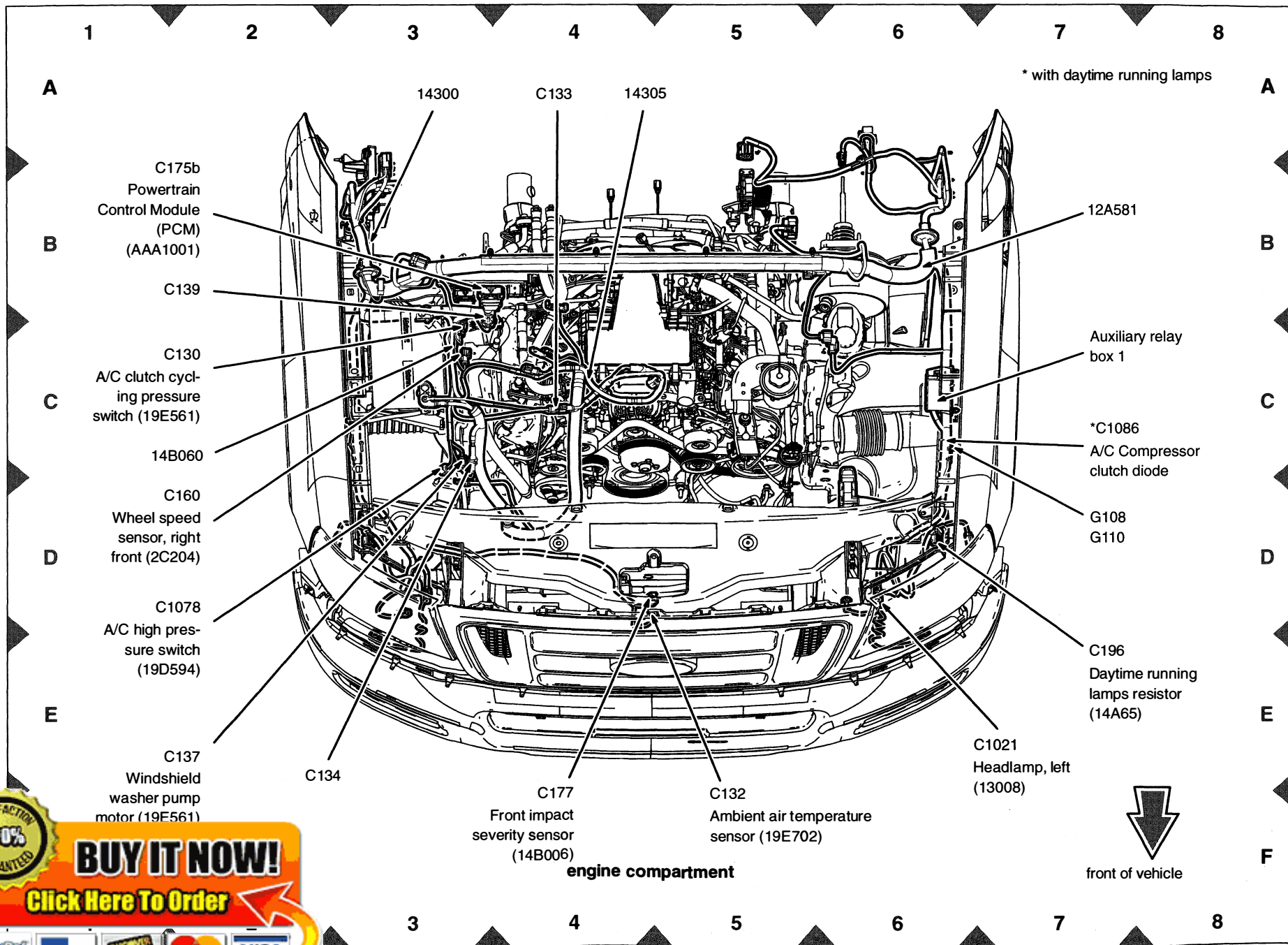

100% SATISFACTION GUARANTEED

BUY IT NOW!

Click Here To Order

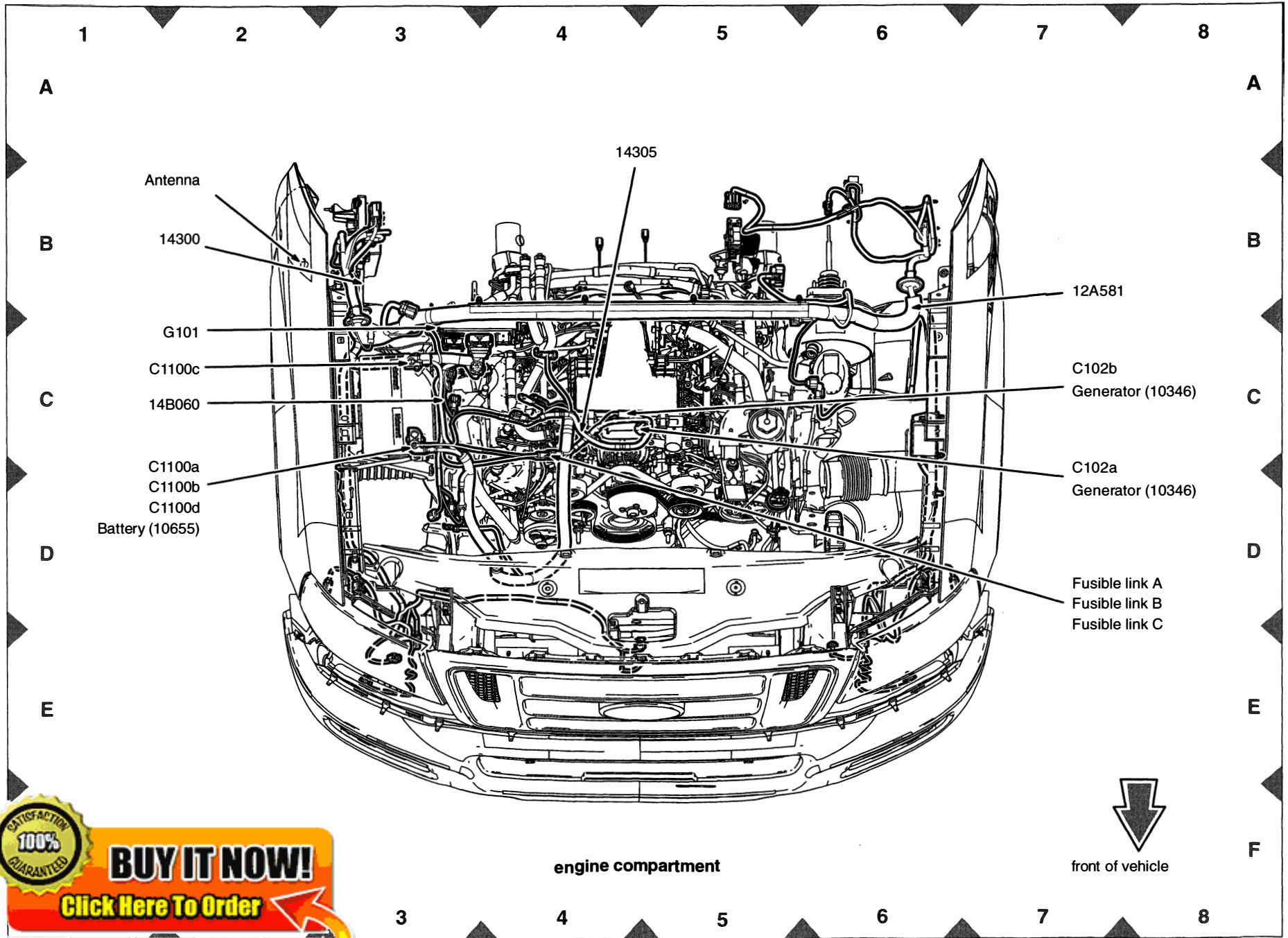

BUY IT NOW!

Click Here To Order





**TECHNICAL
SUPPORT OPERATIONS**
Ford Customer Service Division

DECEMBER 2003

LITHO IN U.S.A.
AD-376



FCS-13791-04