

**100% MONEY BACK GUARANTEE**

**BUY IT NOW!**

**Click Here To Order**



**Buy Now**

# 1996 F150-450

FIX IT RIGHT THE FIRST TIME ON TIME

### DEMO

This DEMO contains only a few pages of the entire manual/product.

Not all Bookmarks work on the Demo, but they do on the full version.

#### Features:

- Searchable text
- Printable pages
- Bookmarked for easy navigation
- High Resolution images
- Zoom to see exact details
- Money back Guarantee
- Available on USB and eBook download



# EVTM

**Official  
Licensed  
Product**

License #84356800

Copyright © 2024, Forel Publishing Company, LLC, Woodbridge, Virginia

All Rights Reserved. No part of this book may be used or reproduced in any manner whatsoever without written permission of Forel Publishing Company, LLC. For information write to Forel Publishing Company, LLC, Woodbridge, VA 22192

**1996 F150-F450/F-Super Duty Electrical & Vacuum  
Trouble-Shooting Manual (EVTM)  
EAN: 978-1-60371-419-8  
ISBN: 1-60371-419-7**

Forel Publishing Company, LLC  
Woodbridge, VA 22192  
Email: [sales@ForelPublishing.com](mailto:sales@ForelPublishing.com)  
<https://www.ForelPublishing.com>



This publication contains material that is reproduced and distributed under a license from Ford Motor Company. No further reproduction or distribution of the Ford Motor Company material is allowed without the express written permission of Ford Motor Company.

---

## Note from the Publisher

This product was created from the original Ford Motor Company's publication. Every effort has been made to use the original scanned images, however, due to the condition of the material; some pages have been modified to remove imperfections.

---

## Disclaimer

Although every effort was made to ensure the accuracy of this book, no representations or warranties of any kind are made concerning the accuracy, completeness or suitability of the information, either expressed or implied. As a result, the information contained within this book should be used as general information only. The author and Forel Publishing Company, LLC shall have neither liability nor responsibility to any person or entity with respect to any loss or damage caused, or alleged to be caused, directly or indirectly by the information contained in this book. Further, the publisher and author are not engaged in rendering legal or other professional services. If legal, mechanical, electrical, or other expert assistance is required, the professional should be sought.



# ELECTRICAL AND VACUUM TROUBLESHOOTING MANUAL

## FCS-12254-96

### FORD CUSTOMER SERVICE DIVISION

## Quality is Job 1

Ford Customer Service Division has continued with the existing format for the 1996 F-SERIES EVTVM. Our goal is to provide accurate and timely electrical and vacuum service information.

### 1996 EVTVM FEATURES

- Schematic pages contain **Component Location** references to full-view illustrations.
- "**COMPONENT TESTING**" procedures (CELL 149) tell the user how to perform diagnostic tests on various circuits.
- **Connector Views** are located at the end of individual cells along with a circuit function chart, and are shown for connectors with five or more cavities.
- **NOTES, CAUTIONS and WARNINGS** contain important safety information.
- Full view "**COMPONENT LOCATION VIEWS**" (CELL 151) help locate on-vehicle components.
- Circuit voltages appear on schematic pages to help simplify troubleshooting. Nonessential troubleshooting hints have been deleted.
- **Cellular Pagination:** Each section (or cell) in the EVTVM is identified by a unique number and starts with page 1. For example: "**HOW TO USE THIS MANUAL**" is CELL 2 and begins with page 2-1.
- "**IN-LINE CONNECTOR FACES**" (CELL 150) shows in-line connectors with six or more terminals, to aid in servicing electrical wiring.
- "C" numbers are assigned for all electrical connectors. "C" numbers are listed in the "**LOCATION INDEX**" (CELL 152).

**NUMBERS**" (CELL 153) aids in identifying warranty concerns.

contain a suffix to denote connector "gender" type (F—socket, M—

### ORDERING INFORMATION

Information about how to order additional copies of this publication or other Ford publications may be obtained by writing to Helm, Incorporated at the address shown below or by calling 1-800-782-4356. Other publications available include:

- Service Manuals
- Service Specification Books
- Car/Truck Wiring Diagrams
- Powertrain Control/Emissions Diagnosis Manuals

Helm Incorporated  
P.O. Box 07150  
Detroit, Michigan 48207



# 1-1 TABLE OF CONTENTS/INDEX

1996 F-SERIES

## Table Of Contents

How to Use This Manual .....	2-1
Grounds .....	10-1
Fuse Panel/Circuit Protection .....	11-1
Charging System .....	12-1
Power Distribution .....	13-1
Starting System .....	20-1
Ignition System .....	21-1
Engine Controls (4.9L) .....	23-1
Engine Controls (5.0L) .....	24-1
Engine Controls (5.8L) .....	25-1
Engine Controls (5.8L & 7.5L Over 8500 GVW) .....	26-1
Engine Control (7.5L) .....	27-1
Engine Controls (7.3L DI Diesel) .....	28-1
Transmission Controls (4R70W) .....	29-1
Transmission Controls (E4OD) .....	30-1
Speed Control .....	31-1
All-Wheel Drive .....	34-1
Shift Lock .....	37-1
Rear Anti-Lock Brakes .....	42-1
Horn/Cigar Lighter .....	44-1
Air Bags .....	46-1
Fuel Tank Selector .....	49-1
Heater .....	53-1
Air Conditioner/Heater .....	54-1
Instrument Cluster .....	60-1
Vehicle Speed Sensor .....	64-1
Warning Indicators .....	65-1
Warning Chime .....	66-1
Instrument Illumination .....	71-1
Interval Wiper/Washer .....	81-1
Headlamps .....	85-1
Courtesy Lamps .....	89-1
Turn Signal/Hazard Lamps .....	90-1
Front Fog Lamps .....	92-1
Engine Compartment Fuse Panel .....	93-1
Transmission Controls .....	95-1
Daytime Running Lamps .....	97-1
Power Windows .....	100-1
Power Door Locks .....	101-1
Keyless Entry .....	101-1
Power Seats .....	122-1

Power Mirrors .....	124-1
Radio .....	130-1
Vacuum Distribution .....	140-1
Component Testing .....	149-1
In-Line Connector Faces .....	150-1
Component Location Views .....	151-1
Location Index .....	152-1
Harness Causal Part Number .....	153-1
Vehicle Repair Location Codes .....	160-1

### Index

4R70W Transmission .....	29-1
Air Bags .....	46-1
All-Wheel Drive:	
Electronic .....	34-1
Mechanical .....	34-3
Air Conditioner/Heater:	
Electrical .....	54-2
Vacuum .....	54-1
Anti-Lock Brakes (Rear) .....	42-1
Charging System .....	12-1
Cigar Lighter .....	44-1
Component Testing:	
A/C Function Selector Switch .....	149-7
Blower Motor Switch .....	149-8
Heater Function Selector Switch .....	149-6
Ignition Switch .....	149-2
Introduction .....	149-1
Main Light Switch .....	149-1
Multi-function Switch .....	149-3 to 149-5
Park/Neutral Position Switch .....	149-10
Tank Selector Valve .....	149-9
Courtesy Lamps .....	89-1
Daytime Running Lamps .....	97-1
Door Locks .....	110-1, 110-2

E4OD Transmission:	
Diesel .....	30-4
Gas .....	30-1
Engine Compartment Fuse Panel:	
Diesel .....	13-10
Gas .....	13-1
Engine Controls:	
4.9L .....	23-1
5.0L .....	24-1
5.8L (Under 8500 GVW) .....	25-1
5.8L & 7.5L (Over 8500 GVW) .....	26-1
7.3L (DI Diesel) .....	28-1
7.5L .....	27-1
Fuel Tank Selector:	
Diesel .....	49-1
Gas .....	49-2
Fuse Panel:	
Fuse 1 .....	13-18
Fuse 2 .....	13-22
Fuse 4 .....	13-21
Fuse 5 .....	13-15
Fuse 6 .....	13-22
Fuse 7 .....	13-18
Fuse 8 .....	13-20
Fuse 9 .....	13-15
Fuse 10 .....	13-23
Fuse 11 .....	13-22
C.B. 12 .....	13-16
Fuse 13 .....	13-15
C.B. 14 .....	13-22
Fuse 15 .....	13-18
Fuse 16 .....	13-16
Fuse 17 .....	13-19
Fuse 18 .....	13-18
Fuse Panel/Circuit Protection .....	11-1
Gauges:	
Coolant Temperature .....	60-2
Fuel .....	60-1
Oil Pressure .....	60-2
Tachometer .....	60-5

**BUY IT NOW!**  
Click Here To Order

PayPal American Express Discover MasterCard VISA

# TABLE OF CONTENTS/INDEX 1-2

1996 F-SERIES

Voltmeter .....	60-1	Plugged Fuel Filter .....	65-1	Diesel .....	20-3
Grounds:		Turn .....	60-4, 90-1	Gas .....	20-1
G100 .....	10-1,10-5	Wait-to-Start .....	65-1	Trailer/Camper Adapter .....	95-1
G101 .....	10-3,10-8	Water-in-Fuel .....	65-1	Vacuum Distribution .....	140-1
G103 .....	10-3	Instrument Cluster .....	60-1	Vehicle Speed Sensor .....	64-1
G104 .....	10-3,10-5	Instrument Illumination .....	71-1	Warning Chime .....	66-1
G106 .....	10-8	Interval Wiper/Washer .....	81-1	Warning Indicators .....	65-1
G107 .....	10-8	Keyless Entry .....	111-1	Windows .....	100-1
G200 .....	10-9,10-11	Lamps (Exterior):		Wiper/Washer (Interval) .....	81-1
G201 .....	10-13	Backup .....	93-3		
G401 .....	10-7	Engine Compartment ....	89-6, 111-5, 92-4		
Headlamps .....	85-1	Hazard .....	90-1		
Heater .....	53-1	License .....	92-3		
Horn .....	44-1	Marker .....	92-1, 92-2, 92-4		
Ignition Switch:		Park .....	92-1, 92-3		
Diesel .....	13-12	Stop .....	90-3, 90-4		
Gas .....	13-3	Turn:			
Ignition System .....	21-1	Front .....	90-1		
Indicators:		Rear .....	90-3, 90-4		
4 x 4 .....	60-3	Lamps (Interior):			
Air Bags .....	46-2, 60-3	Dome/Map/Cargo ....	89-2, 89-5, 89-6, 111-5		
Anti-lock Brake .....	42-1, 60-3	Courtesy Lamps ....	89-2, 89-4, 89-6, 111-4		
Brake Fluid Level .....	60-6	Lumbar Seats:			
Brake Warning .....	60-6	Bench .....	122-2		
Charge:		Captain's Chairs .....	122-1, 122-3		
Diesel .....	12-2, 12-3, 60-4	Main Light Switch .....	13-23		
Gas .....	12-1, 60-4	Mega Fuse .....	13-10		
Engine Warning .....	65-1	Mirrors .....	124-1		
Fasten Seat Belt .....	60-4, 66-1	Power Distribution .....	13-1		
Hi Beam .....	60-4, 85-1	Programmable Speedometer/ Odometer Module .....	60-7, 64-1		
Low Range .....	60-3	Radio .....	130-1		
Malfunction:		Shift Lock .....	37-1		
4.9L .....	23-7, 60-3	Speed Control Servo/Amplifier Assembly .....	31-1, 31-2		
5.0L .....	24-7, 60-3	Starting System:			
5.8L .....	25-5, 60-3				
5.8L & 7.5L (Over 8500 GVW) ..	26-5, 60-3				
	28-2, 60-3				
	27-7, 60-3				

## IMPORTANT SAFETY NOTICE

*Appropriate service methods and proper repair procedures are essential for the safe, reliable operation of all motor vehicles, as well as the personal safety of the individual doing the work. This Manual provides general directions for accomplishing service and repair work with tested, effective techniques. Following them will help assure reliability.*

*There are numerous variations in procedures, techniques, tools, and parts for servicing vehicles, as well as in the skill of the individual doing the work. This Manual cannot possibly anticipate all such variations and provide advice or cautions as to each. Accordingly, anyone who departs from the instructions provided in this Manual must first establish that they compromises neither their personal safety nor the vehicle integrity by their choice of methods, tools or parts.*



# 2-1 HOW TO USE THIS MANUAL

1996 F-SERIES

The purpose of this manual is to show electrical and vacuum circuits in a clear and simple fashion to make troubleshooting easier. **NOTES, CAUTIONS** and **WARNINGS** contain important information.

- **NOTES** describe how switches and other components operate to help complete a particular procedure.
- **CAUTIONS** provide information that could prevent making an error that may damage the vehicle.
- **WARNINGS** provide information to prevent personal injury.

The **WARNINGS** list on page 2-2 contains general warnings to follow when servicing a vehicle.

Components that work together are shown together. All electrical components used in a specific system are shown on one diagram. The circuit breaker or fuse is shown at the top of the page. All wires, connectors, components and splices are shown in the flow of current to ground at the bottom of the page. If a component is used in several different systems, it is shown in several places. For example, the Main Light Switch is electrically a part of many systems and is repeated on many pages.

In some cases, a component may seem (by its name) to belong to a system where it has no electrical connection. For example, Radio Illumination is electrically part of Instrument Illumination, but because it has no electrical connection to the Radio system, it is not shown on

text blocks located next to each component and connector and refer the user to the appropriate illustration page and zone. The description notes describe the operation of the component.

Schematic pages contain circuit voltages to help simplify troubleshooting hints. 12V is used to imply battery voltage on a component connector terminal, and 0V is used to show that there should be continuity to ground on that particular terminal. Conditional voltages such as "12V with the ignition switch in RUN" will also be provided. Troubleshooting hints that can't be simplified with circuit voltages will be shown at the end of each cell.

Component connector face information specific to a certain cell is found at the end of that cell. A Connector Face Reference List is provided to locate connector faces that are shown in different cells. Component connectors with five or more terminals are illustrated and are accompanied by a pinout chart that lists the function of all circuitry associated with that component.

**"GROUNDS"** (Cell 10) contains ground circuitry shown in complete detail. This information is useful for checking interconnections of the ground circuits of different systems.

**"POWER DISTRIBUTION"** (Cell 13) contains power distribution circuitry shown in complete detail. This section displays how the various fuses are powered and, in turn, how each system is powered.

**"COMPONENT TESTING"** (Cell 149) contains testing procedures for various switches. This information includes schematics, component terminal locations and step-by-step procedures.

**"IN-LINE CONNECTOR FACES"** (Cell 150) contains illustrations of all the in-line connectors that have 6 or more terminals. The terminals have pin numbers assigned to them.

**"COMPONENT LOCATION VIEWS"** (Cell 151) contains full-view illustrations which show the location of all components and connectors in the vehicle.

The **"LOCATION INDEX"** (Cell 152) provides the base part numbers, locations, connector face references and illustration references for all components, connectors, splices and grounds.

## HELPFUL REMINDERS

Before using the EVTM for troubleshooting, refer to these HELPFUL REMINDERS:

1. The abbreviation T/O, for take out, used in the Location Index (Cell 152), refers to the point at which a group of wires branch off the harness trunk. Refer to the wiring harness illustration.

100% SATISFACTION GUARANTEED

**BUY IT NOW!**

Click Here To Order

PayPal American Express Discover MasterCard VISA

Wiring harness at back of Instrument Panel, showing typical T/O (Take Out) locations

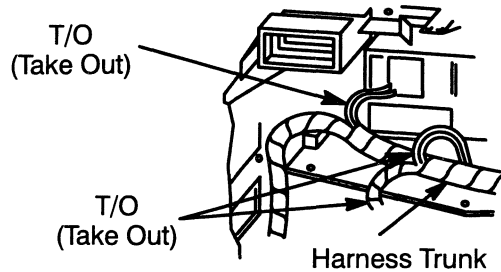

- If a connector serves the same purpose in two separate versions (e.g., Automatic/Manual), but is physically different, two connector numbers are used. However, if a connector serves the same purpose in two separate versions (e.g., Automatic/Manual) and is physically the same, but the wire colors are different, only *one* connector number is used. If the same physical connector is used more than once, then more than *one* connector number is used.
- Wiring schematics provide a picture of how and under what conditions the circuit is powered, of the current path to circuit components, and of how a circuit is grounded. Each circuit component is named (underlined titles). Wire and connector colors are listed as follows (standard Ford color abbreviations are used):

## COLOR ABBREVIATIONS

BL	Blue	N	Natural
BK	Black	O	Orange
BR	Brown	PK	Pink
DB	Dark Blue	P	Purple
DG	Dark Green	R	Red
GN	Green	T	Tan
GY	Gray	W	White
LB	Light Blue	Y	Yellow
LG	Light Green		

**Note:** Whenever a wire is labeled with two colors, the first color listed is the basic color of the wire, and the second color listed is the stripe marking of the wire.

- When reporting Vehicle Repair Location Codes to Ford Customer Service Division, refer to Cell 160 (beginning on page 160-1). Note: Do *not* use the illustrations in Cell 151 (beginning on page 151-1) for reporting Vehicle Repair Location Codes.

## 5. WARNINGS

- Always wear safety glasses for eye protection.
- Use safety stands whenever a procedure requires being under a vehicle.
- Be sure that the Ignition Switch is always in the OFF position, unless otherwise required by the procedure.
- Set the parking brake when working on any vehicle. An automatic transmission should be in PARK. A manual transmission should be in NEUTRAL.
- Operate the engine only in a well-ventilated area to avoid danger of carbon monoxide.

- Keep away from moving parts, especially the fan and belts, when the engine is running.
- To prevent serious burns, avoid contact with hot metal parts such as the radiator, exhaust manifold, tail pipe, catalytic converter and muffler.
- Do not allow flame or sparks near the battery. Gases are always present in and around the battery cell. An explosion could occur.
- Do not smoke when working on a vehicle.
- To avoid injury, always remove rings, watches, loose hanging jewelry and avoid wearing loose clothing.

## HOW TO FIND ELECTRICAL CONCERNS

### TROUBLESHOOTING STEPS

These six steps present an orderly method of troubleshooting.

#### Step 1. Verify the concern.

- Operate the complete system to check the accuracy and completeness of the customer's complaint.

#### Step 2. Narrow the concern.

- Using the EVT/M, narrow down the possible causes and locations of the concern to pinpoint the exact cause.
- Read the description notes at the components and study the wiring schematic. You should then know enough about the circuit operation to determine where to check for the trouble. Further information can be found by referring to the Service Manual pages listed in the box at the top of the page.

**100% SATISFACTION GUARANTEED**

**BUY IT NOW!**

**Click Here To Order**

# 2-3 HOW TO USE THIS MANUAL

1996 F-SERIES

## Step 3. Test the suspected cause.

- Use electrical test procedures to find the specific cause of the symptoms.
- The component location reference bars and the pictures will help you find components. The Location Index (at the end of the manual) gives component location information for connectors, diodes, resistors, splices and grounds.

## Step 4. Verify the cause.

- Confirm that you have found the correct cause by connecting jumper wires and/or temporarily installing a known good component and operating the circuit.

## Step 5. Make the repair.

- Repair or replace the inoperative component.

## Step 6. Verify the repair.

- Operate the system as in Step 1 and check that your repair has removed all symptoms without creating any new symptoms.

Some engine circuits may need special test equipment and special procedures. See the *Service Manual* and other service books for details. You will find the circuits in this manual to be helpful with those special test procedures.

## TROUBLESHOOTING TOOLS

### JUMPER WIRE

This is a test lead used to connect two points of a circuit. A Jumper Wire can bypass an open to complete a circuit.

**100% SATISFACTION GUARANTEED**

**BUY IT NOW!**

**Click Here To Order**

PayPal   American Express   Discover   MasterCard   VISA

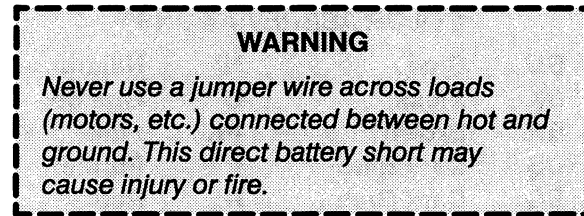

### VOLTMETER

A DC Voltmeter measures circuit voltage. Connect negative (- or black) lead to ground, and positive (+ or red) lead to voltage measuring point.

### OHMMETER

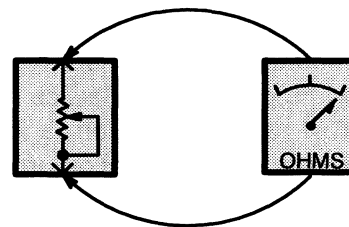

Figure 1—Resistance Check

An Ohmmeter shows the resistance between two connected points (Figure 1).

### TEST LAMP

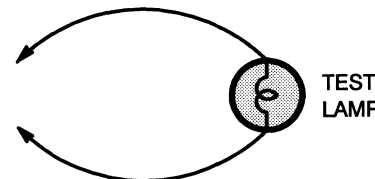

Figure 2—Test Lamp

A Test Light is a 12-volt bulb with two test leads (Figure 2).

Uses: Voltage Check, Short Check.

### SELF-POWERED TEST LAMP

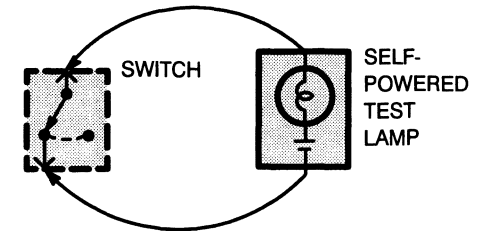

Figure 3—Continuity Check

The Self-Powered Test Lamp is a bulb, battery and set of test leads wired in series (Figure 3). When connected to two points of a continuous circuit, the bulb glows.

Uses: Continuity Check, Ground Check.

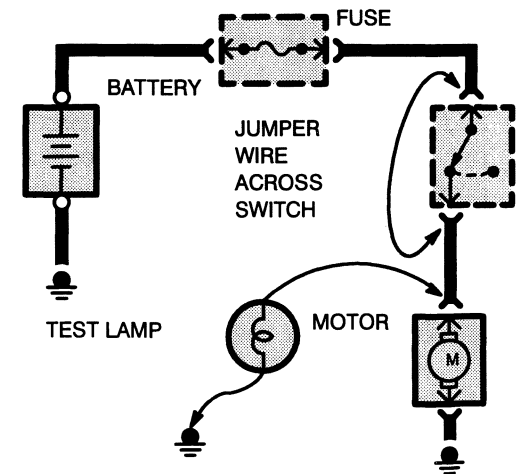
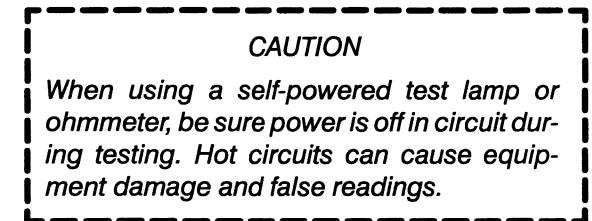

Figure 4—Switch Circuit Check and Voltage Check

In an inoperative circuit with a switch in series with the load, jumper the terminals of the switch to power the load. If jumpering the terminals powers the circuit, the switch is inoperative (Figure 4).

## CONTINUITY CHECK (Locating open circuits)

Connect one lead of Self-Powered Test Lamp or Ohmmeter to each end of circuit (Figure 3). Lamp will glow if circuit is closed. Switches and fuses can be checked in the same way.

## VOLTAGE CHECK

Connect one lead of test lamp to a known good ground or the negative (-) battery terminal. Test for voltage by touching the other lead to the test point. Bulb goes on when the test point has voltage (Figure 4).

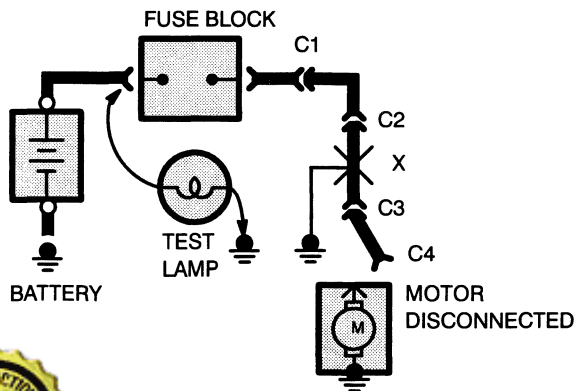

A fuse that repeatedly blows is usually caused by a short to ground. It's important to be able to locate such a short quickly (Figure 5).

1. Turn off everything powered through the fuse.
2. Disconnect other loads powered through the fuse:
  - Motors: disconnect motor connector (Connector C4 in Figure 5).
  - Lights: remove bulbs.
3. Turn Ignition Switch to RUN (if necessary) to power fuse.
4. Connect one Test Lamp lead to hot end of blown fuse. Connect other lead to ground. Bulb should glow, showing power to fuse. *(This step is just a check to be sure you have power to the circuit.)*
5. Disconnect the test lamp lead that is connected to ground, and reconnect it to the load side of the fuse at the connector of the disconnected component. (In Figure 5, connect the test lamp lead to connector C4.)
  - If the Test Lamp is off, the short is in the disconnected component.
  - If the Test Lamp goes on, the short is in the wiring. You must find the short by disconnecting the circuit connectors, one at a time, until the Test Lamp goes out. For example, in Figure 5 with a ground at X, the bulb goes out when C1 or C2 is disconnected, but not after disconnecting C3. This means the short is between C2 and C3.

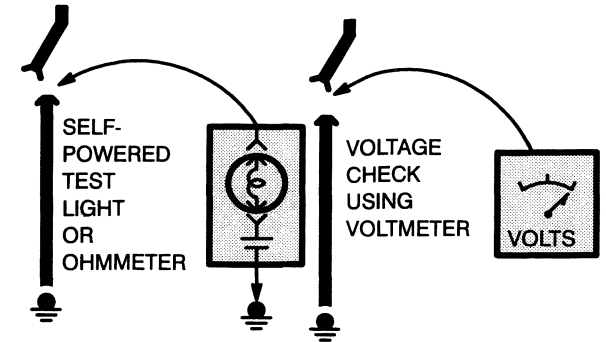

**Figure 6—Ground Check**

Turn on power to the circuit. Perform a Voltage Check between the suspected inoperative ground and the frame. Any indicated voltage means that the ground is inoperative (Figure 6).

Turn off power to the circuit. Connect one lead of a Self-Powered Test Lamp or Ohmmeter to the wire in question and the other lead to a known ground. If the bulb glows, the circuit ground is OK (Figure 6).

The circuit schematics in this manual make it easy to identify common points in circuits. This knowledge can help narrow the concern to a specific area. For example, if several circuits fail at the same time, check for a common power or ground connection (see *Power Distribution* or *Grounds*). If part of a circuit fails, check the connections between the part that works and the part that doesn't work.

For example, if the lo beam headlights work, but the high beams and the indicator lamp don't work, then power and ground paths must be good. Since the dimmer switch is the component that switches this power to the high beam lights and indicator, it is most likely the cause of failure.

**100% SATISFACTION GUARANTEED**

**BUY IT NOW!**

**Click Here To Order**

# 2-5 HOW TO USE THIS MANUAL

1996 F-SERIES

## TROUBLESHOOTING WIRING HARNESS AND CONNECTOR HIDDEN CONCERNS

The following illustrations are known examples of wiring harness, splices and connectors that will create intermittent electrical concerns. The concerns are hidden and can only be discovered by a physical evaluation as shown in each illustration.

**NOTE:** When servicing gold plated terminals in a connector, only replace with the gold plated terminals designed for that connector.

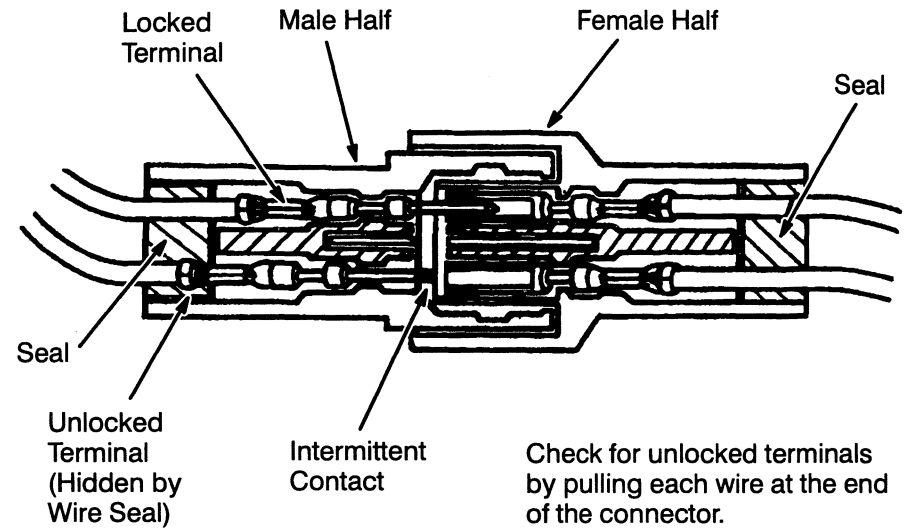

### TERMINAL NOT PROPERLY SEATED

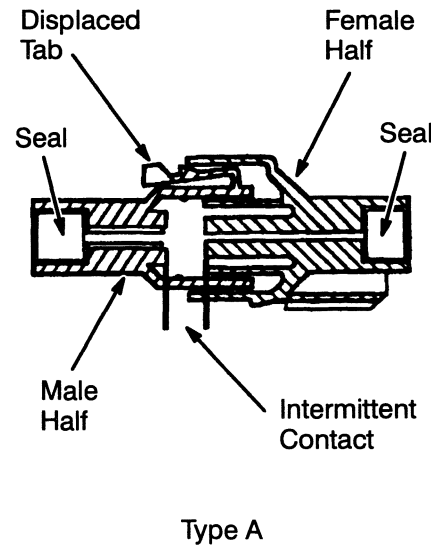
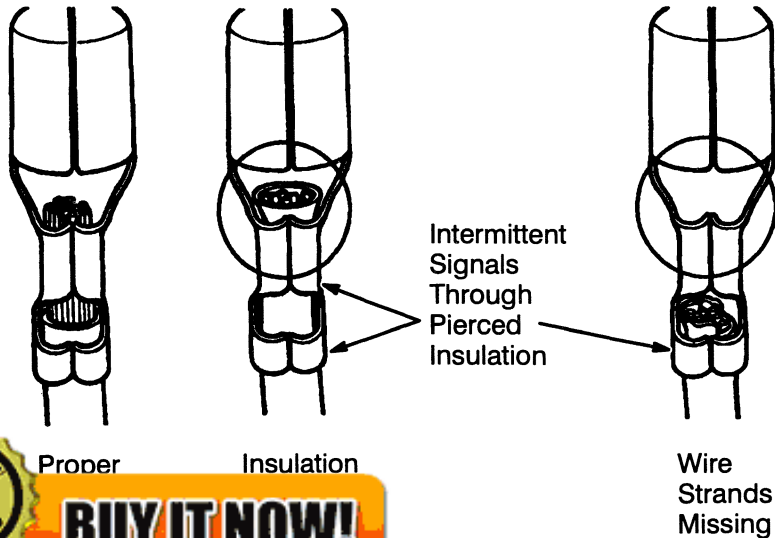

Lock may be displaced into an unlocked position; pull on the connector to verify the lock.

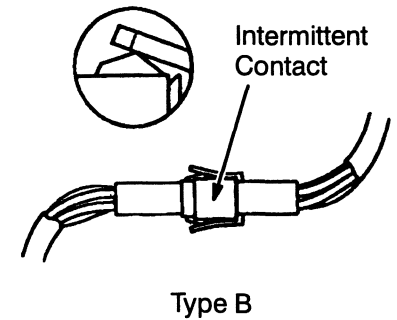

### PARTIALLY MATED CONNECTORS

**100% SATISFACTION GUARANTEED**

**BUY IT NOW!**

**Click Here To Order**

PayPal, American Express, Discover, MasterCard, VISA

ATION STRIPPING

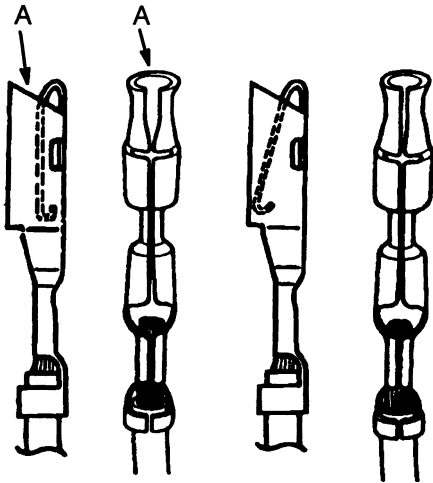

Enlarged

Normal

Any probe entering the terminal may enlarge the contact spring opening creating an intermittent signal. Insert the correct mating terminal (Location A) from the service kit and feel for a loose fit.

## DEFORMED (ENLARGED) FEMALE TERMINALS

Solder Coated Wire to Ground

Solder coated wire pierced through the insulation of another circuit.

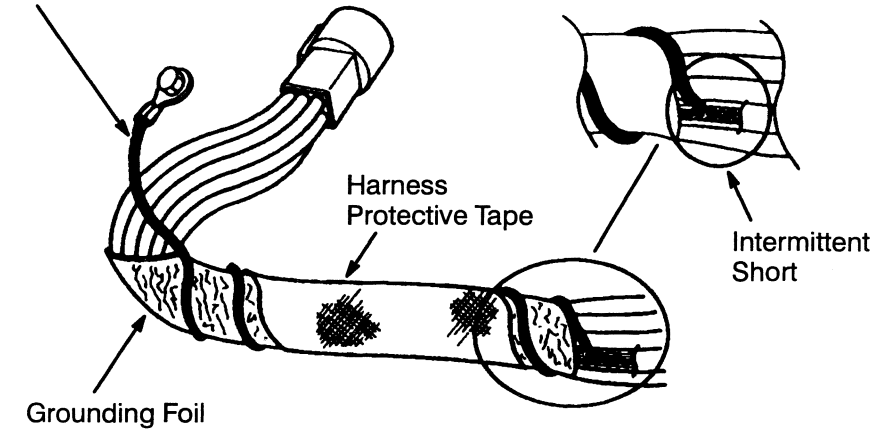

## ELECTRICAL SHORT INSIDE THE HARNESS

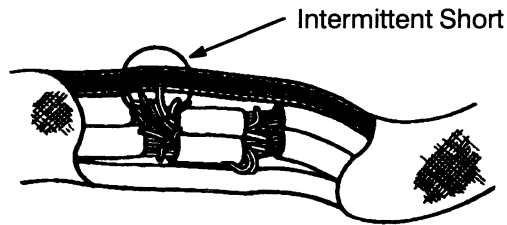

Intermittent Short

Operate the system and flex the harness at splice location noted in Section 152.

Splice Tape Removed

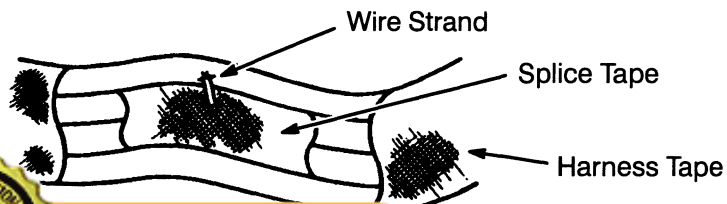

Wire Strand

Splice Tape

Harness Tape

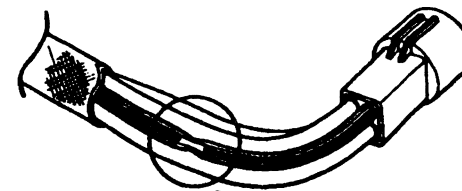

Remove the tape and flex/feel each circuit for a reduction in diameter at break.

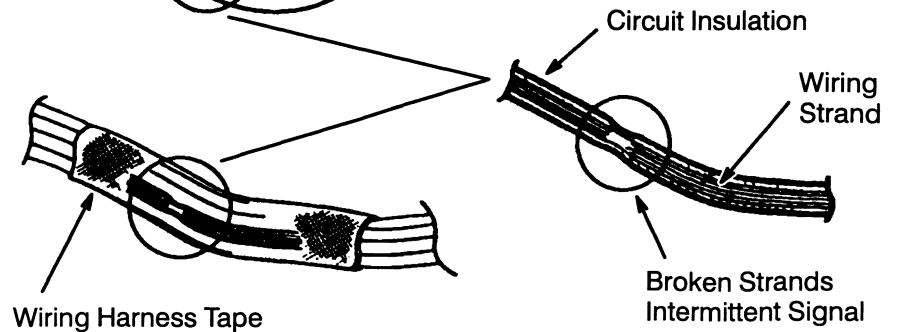

Wiring Harness Tape

Circuit Insulation

Wiring Strand

Broken Strands Intermittent Signal

## BROKEN WIRE STRANDS IN HARNESS



**BUY IT NOW!**

**Click Here To Order**

WITHIN THE HARNESS



# 2-7 HOW TO USE THIS MANUAL

1996 F-SERIES

## HOW TO FIND THE VACUUM CONCERNS

These six steps present an orderly method of troubleshooting.

### Step 1. Verify the concern.

- Operate the system and observe all symptoms to check the accuracy and completeness of the customer's complaint.

### Step 2. Narrow the concern.

- Narrow down the possible causes and locations of the concern to pinpoint the exact cause.

### Step 3. Test the suspected cause.

- Use test procedures to find the specific cause of the symptoms.

### Step 4. Verify the cause.

- Confirm that you have found the right cause by operating the parts of the circuit you think are good.

### Step 5. Make the repair.

- Repair or replace the inoperative component.

### Step 6. Verify the repair.

- Operate the system as in Step 1. Check that your repair has removed all symptoms without creating any new symptoms.

**NOTE: Vacuum system problems fall into three groups.**

1. Leaks in hoses, connectors or motor diagrams.



**BUY IT NOW!**

**Click Here To Order**

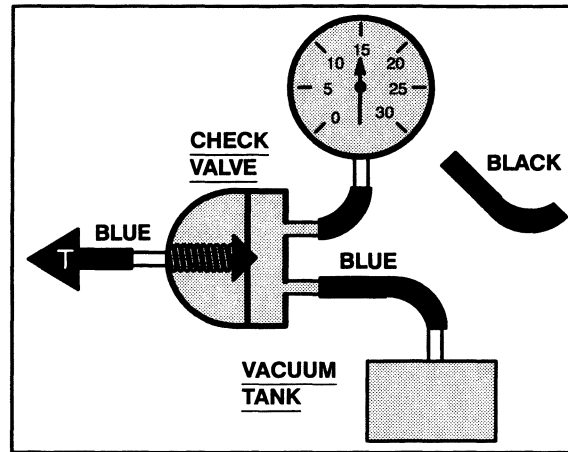

Figure 1 – System Supply Test

### Vacuum Supply Test

1. Connect Vacuum Tester to system side of Check Valve (Figure 1).
2. Start engine. Gauge should show approximately 15 inches of vacuum.
3. Turn off engine, and observe gauge:
  - If vacuum holds, supply OK.
  - If vacuum fails, replace Check Valve or Tank.

### Leak Test

1. Connect Vacuum Gauge and Vacuum Pump (Figure 2) to system hose in place of tank.
2. Open valve and start pump. Operate control in all modes.
3. Listen for hiss and observe gauge.

**NOTE: Hissing is normal at Function Control when changing modes.**

If system hisses or loses vacuum, find system leak as follows:

1. Turn on Vacuum Pump and check vacuum build-up.
2. Stop pump; vacuum should drop.
3. Clamp supply hoses with needlenose pliers, one at a time, until vacuum stops dropping (Figure 2).
4. Check vacuum schematic to find components in that line.
5. Clamp hoses through circuit to find leak.

### Component Test

1. Connect Vacuum Tester to component.
2. Pump Vacuum Tester. Check that all components operate correctly and vacuum holds.
3. Replace component if vacuum does not hold.

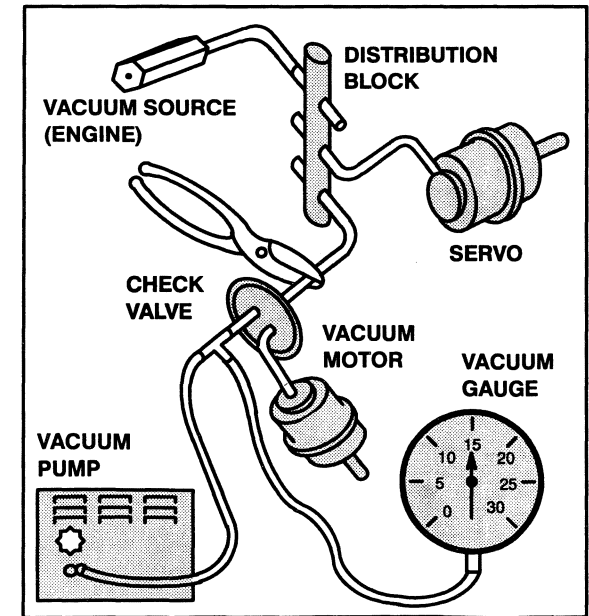
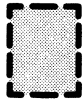
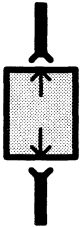

Figure 2 – Testing For Leaks In Typical Vacuum System

## ELECTRICAL SYMBOLS



**DASHED COMPONENT BOX**  
ONLY PART OF THE COMPONENT IS SHOWN ON THE PAGE; THE COMPONENT IS SHOWN COMPLETE IN ANOTHER LOCATION



**COMPONENT WITH CONNECTORS**

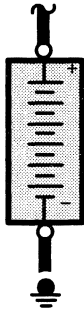

**BATTERY**

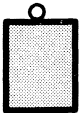

**SCREW TERMINAL ON COMPONENT**

**SOLID STATE**

**SEALED ELECTRONIC COMPONENT**  
ANY CIRCUITRY SHOWN INSIDE THE BOX IS A FUNCTIONAL

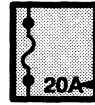

**FUSE**

CURRENT RATING

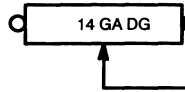

**FUSIBLE LINK**

WIRE SIZE AND COLOR



**MAXI-FUSE or FUSIBLE LINK CARTRIDGE**

CURRENT RATING

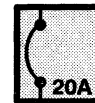

**CIRCUIT BREAKER**

CURRENT RATING

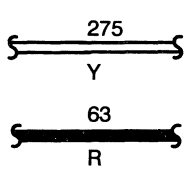

**SOLID WIRES**

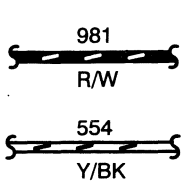

**STRIPED WIRES**

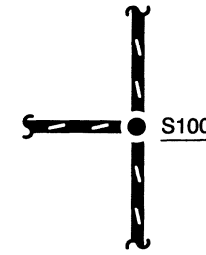

**SPLICE OR CRIMP TERMINAL**

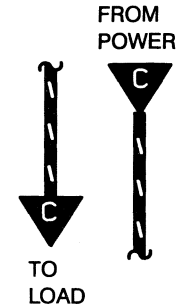

**"CUT" WIRES REFERENCED BETWEEN PAGES**  
ARROWS SHOW CURRENT FLOW FROM POWER TO GROUND



**BACKUP LIGHTS**

**"REFERENCE" WIRES**  
COMPLETE WIRING SHOWN ON ANOTHER PAGE

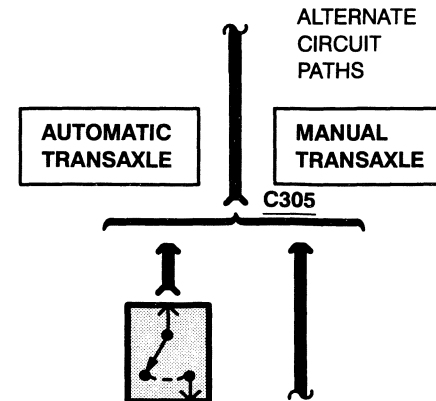

**BUY IT NOW!**

**Click Here To Order**



# 2-9 HOW TO USE THIS MANUAL

1996 F-SERIES

## ELECTRICAL SYMBOLS

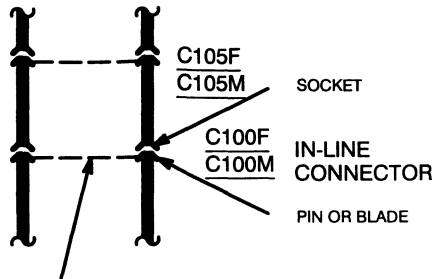

SINGLE DASHED LINE INDICATES THAT WIRE ON LEFT ALSO PASSES THROUGH THE SAME CONNECTOR

SEE GROUNDS  
PAGES 10-1,  
10-2



DASHED WIRE CIRCUITRY IS NOT SHOWN IN COMPLETE DETAIL, BUT IS COMPLETE ON ANOTHER PAGE

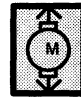
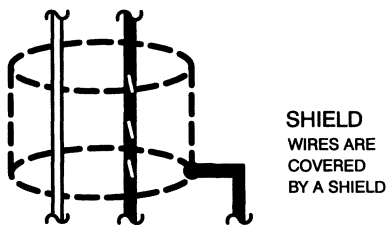

MOTOR



HEATING ELEMENT



THERMISTOR



RHEOSTAT OR POTENTIOMETER



SOLENOID

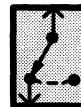

SWITCH

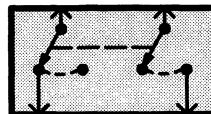

GANGED SWITCHES  
CONTACTS MOVE AT THE SAME TIME



DIODES  
CURRENT FLOWS IN DIRECTION OF ARROW ONLY

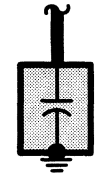

CAPACITOR



TRANSISTOR



GAUGE



LIGHT EMITTING DIODE (LED)



LIGHT BULB

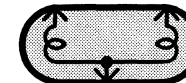

DUAL FILAMENT LIGHT BULB

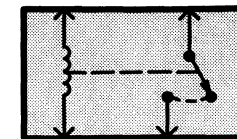

RELAY  
CONTACTS CHANGE POSITION WITH CURRENT THROUGH COIL

FIELD COIL

**100% SATISFACTION GUARANTEED**

**BUY IT NOW!**

Click Here To Order

PayPal   American Express   Discover   MasterCard   VISA

## VACUUM SYMBOLS

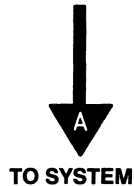
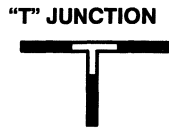

"CUT" HOSES REFERENCED BETWEEN PAGES  
ARROW SHOWS FROM MANIFOLD FITTING TO COMPONENT

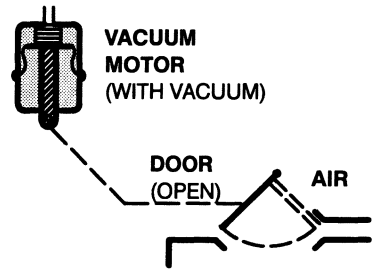
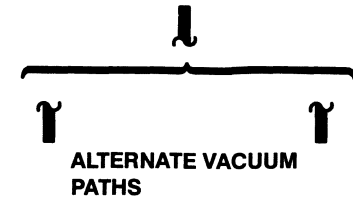

VACUUM ON VACUUM MOTOR PULLS DOOR OPEN TO LET AIR PASS THROUGH

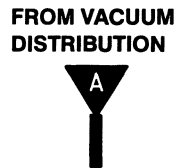

**NOTE**  
OTHER VACUUM SYMBOLS USED ON VACUUM SYSTEM DIAGRAMS ARE FULLY EXPLAINED ON THE PAGES WHERE THEY APPEAR.

## VACUUM MOTOR OPERATION

### SINGLE DIAPHRAGM MOTOR

NO VACUUM

VACUUM



### SERVO MOTOR

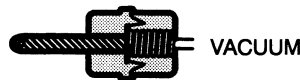

Some vacuum motors can position the actuating arm at any position between fully extended and fully retracted. The Servo is operated by a control valve that applies varying amounts of vacuum to the motor. The higher the vacuum level, the greater the retraction of the motor arm. Servo Motors work nearly the same way as two-position motors, except for the way the vacuum is applied. Servo Motors are generally larger and provide a calibrated control.

### DOUBLE DIAPHRAGM MOTOR

NO VACUUM

NO VACUUM

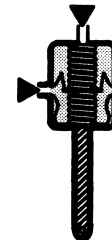

VACUUM

NO VACUUM

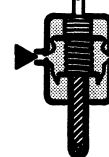

VACUUM

VACUUM



A double diaphragm motor has three positions (it is actually two motors in one housing). When the top port gets vacuum, the shaft pulls halfway in. When both ports get vacuum, the shaft pulls all the way in.



Vacuum motors operate like electrical solenoids, mechanically pushing or pulling a shaft. Vacuum is applied to the motor, and the shaft moves in or out the way out.

**BUY IT NOW!**

Click Here To Order



# 10-1 GROUNDS

1996 F-SERIES

All circuits are 57 (BK) unless otherwise noted.

**GASOLINE**

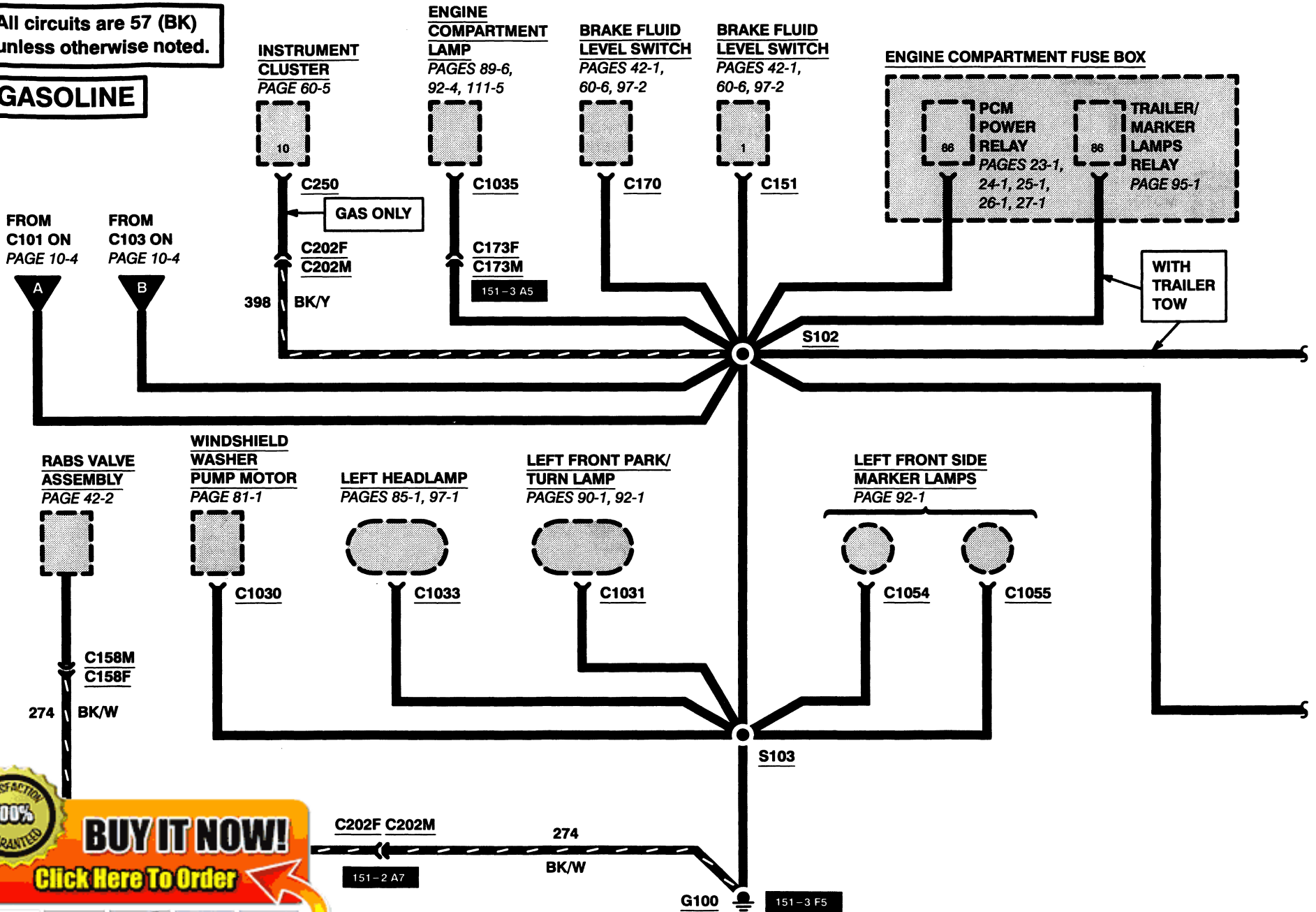

**100% SATISFACTION GUARANTEED**

**BUY IT NOW!**

[Click Here To Order](#)

PayPal    American Express    Discover    MasterCard    VISA

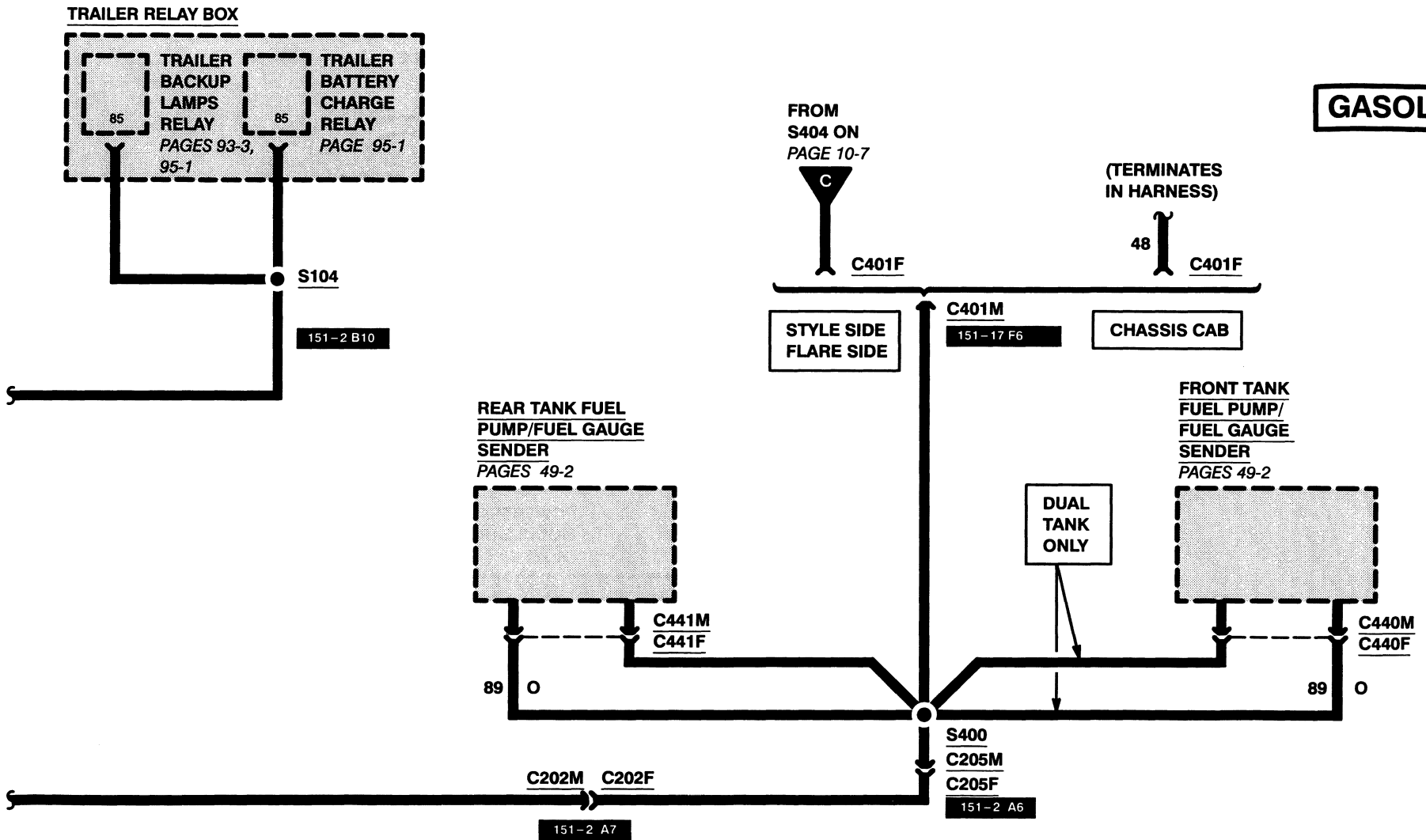

**100% SATISFACTION GUARANTEED**

**BUY IT NOW!**

**Click Here To Order**

PayPal, American Express, Discover, MasterCard, VISA



## GASOLINE

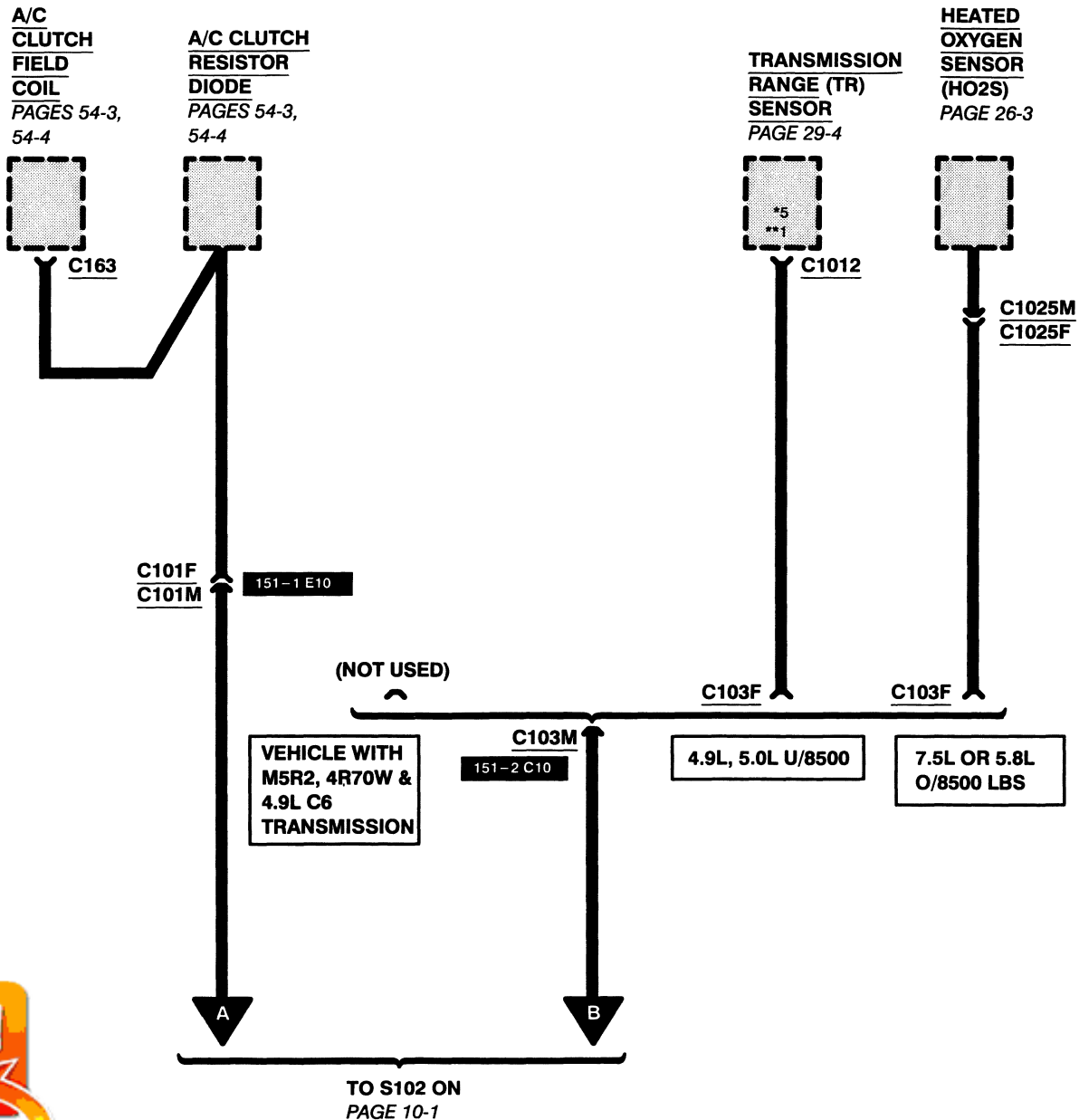

**100% SATISFACTION GUARANTEED**

**BUY IT NOW!**

[Click Here To Order](#)

PayPal

Discover Cards

AMERICAN EXPRESS

MasterCard

VISA



**DIESEL**

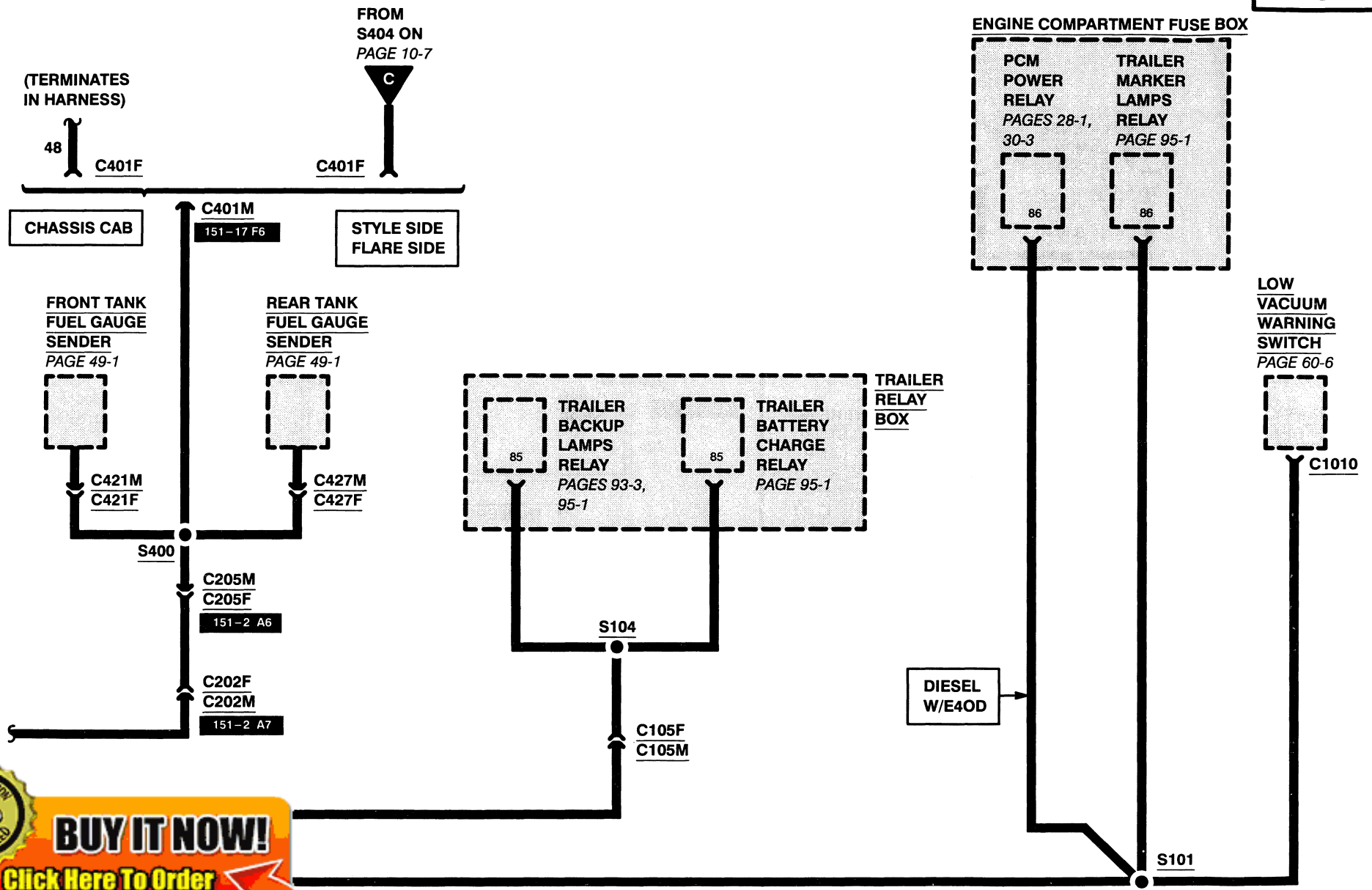

**100% SATISFACTION GUARANTEED**

**BUY IT NOW!**

Click Here To Order

PayPal | American Express | Discover | MasterCard | VISA

# 10-7 GROUNDS

1996 F-SERIES

All circuits are 57 (BK) unless otherwise noted.

**STYLE SIDE  
FLARE SIDE**

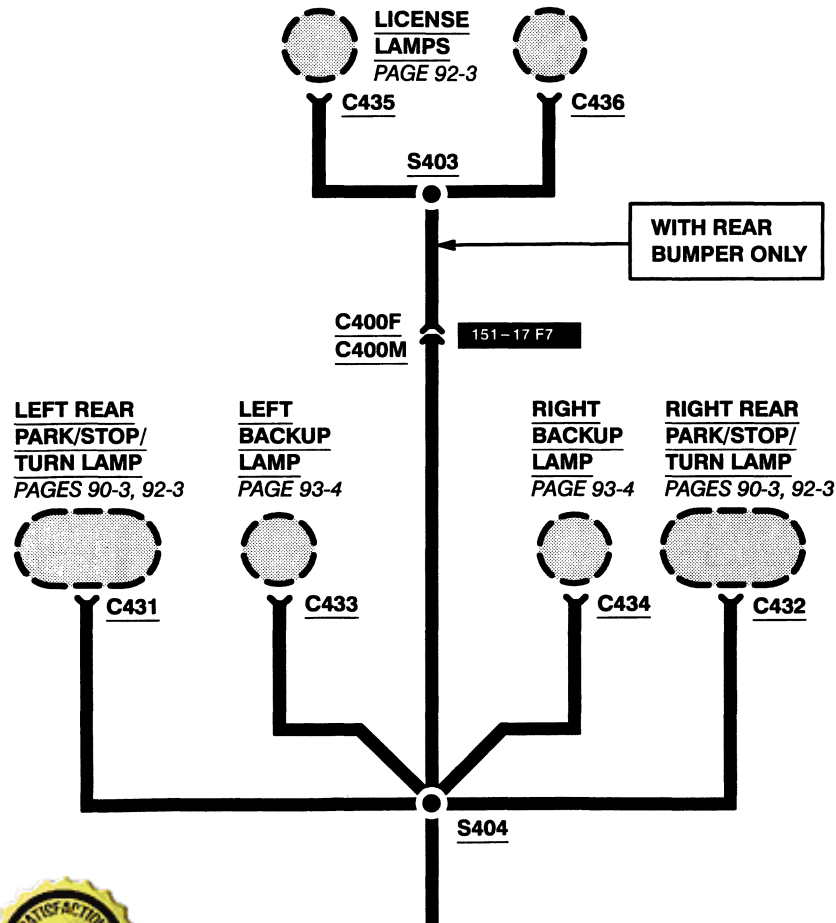

**F350 DUAL REAR WHEEL**

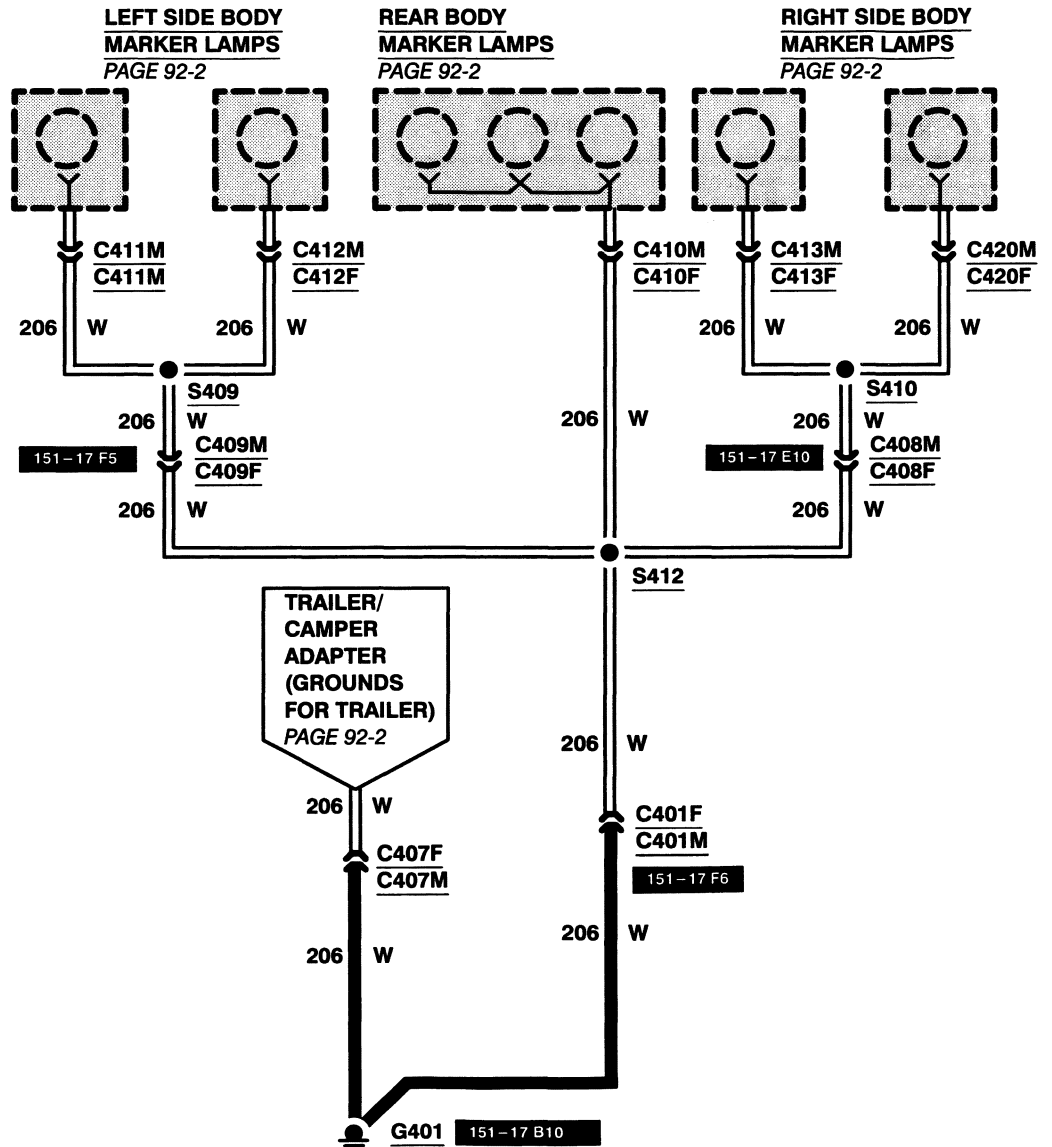

**BUY IT NOW!**

Click Here To Order

(COLINE)

Pages 10-8 with (L)



**DIESEL**

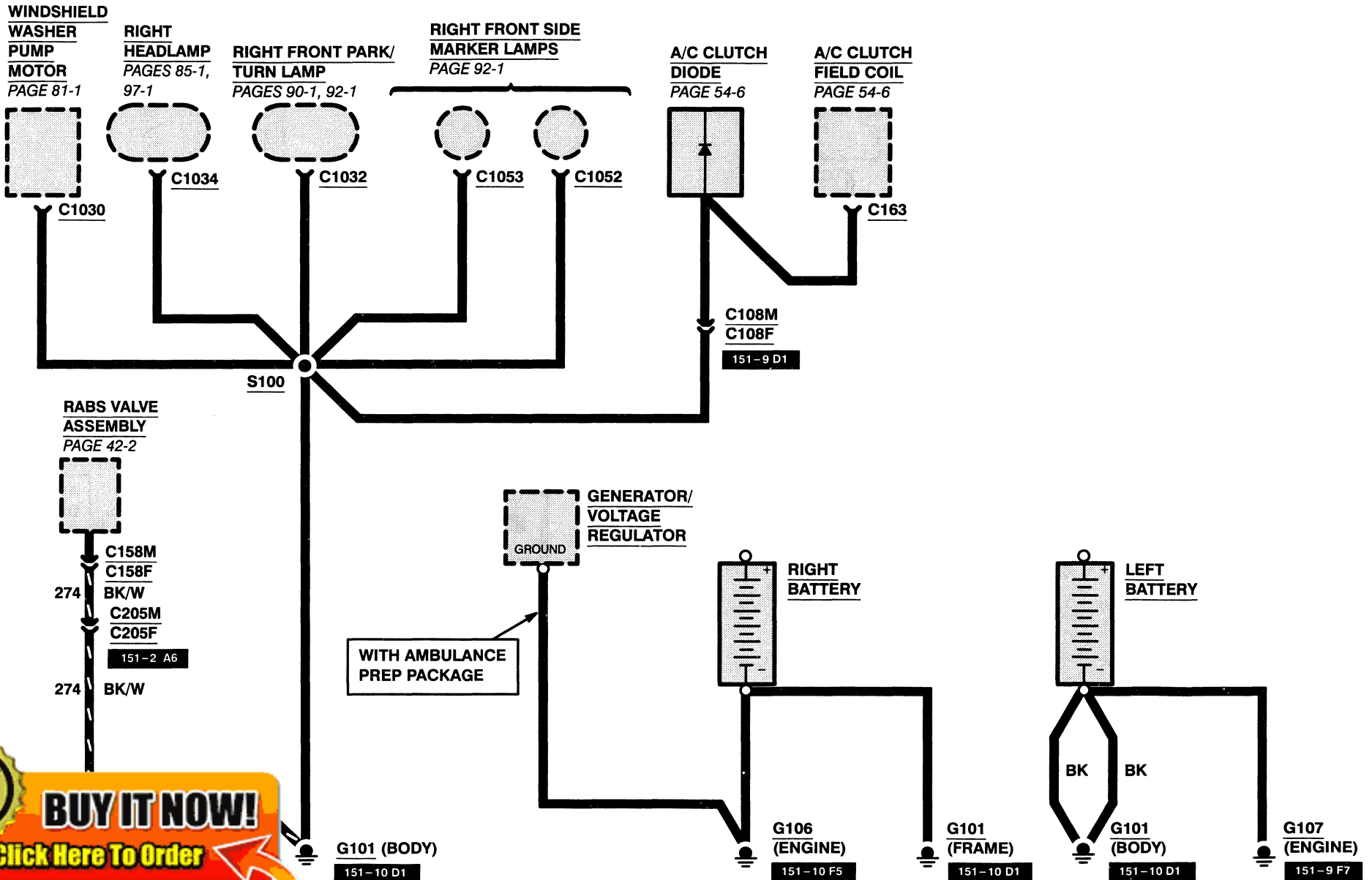

**100% SATISFACTION GUARANTEED**

**BUY IT NOW!**

[Click Here To Order](#)

PayPal American Express Discover Novus MasterCard VISA

# 10-9 GROUNDS

1996 F-SERIES

## ALL GAS/DIESEL WITHOUT TRACTION ASSIST

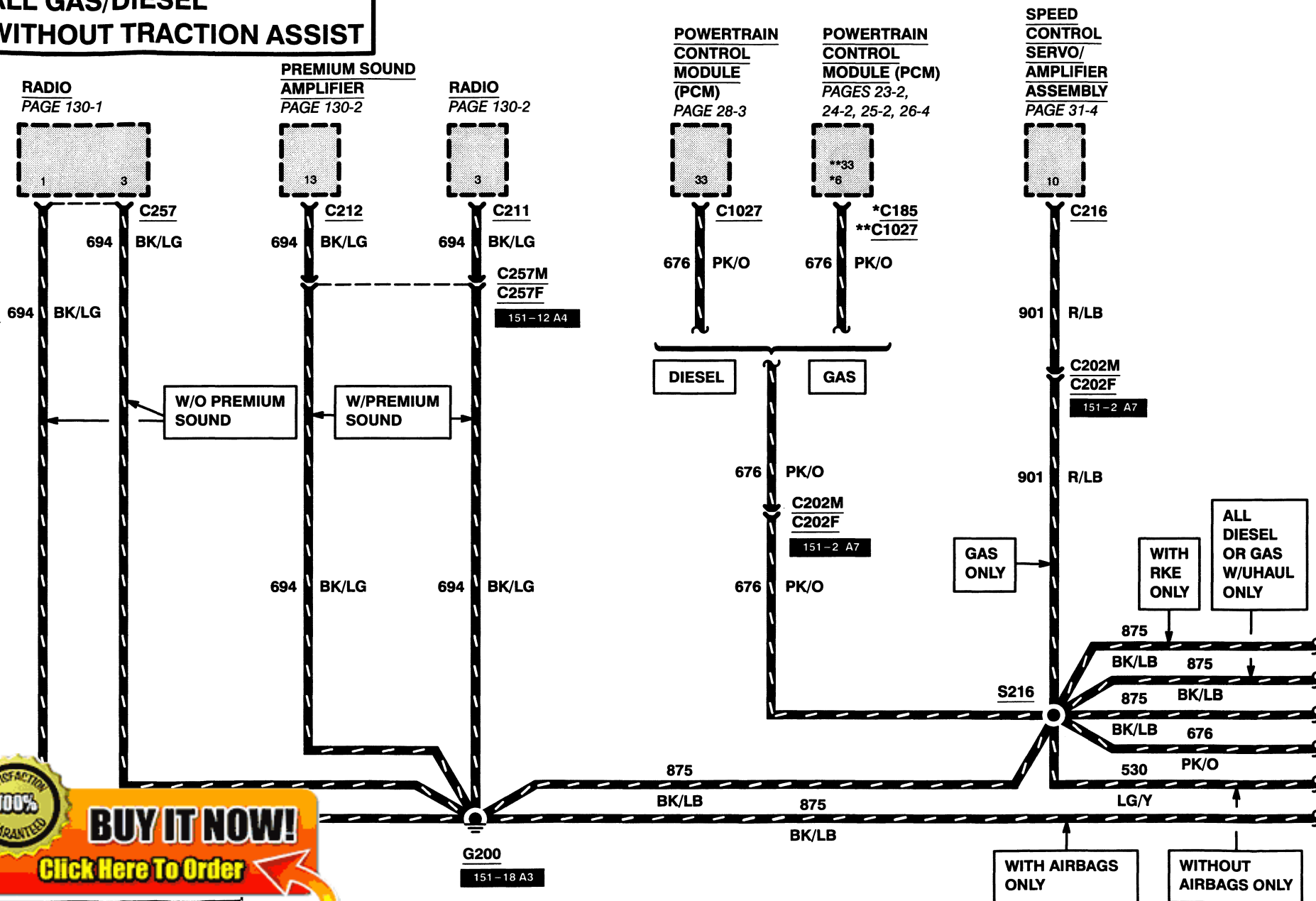

**100% SATISFACTION GUARANTEED**

**BUY IT NOW!**

**Click Here To Order**

**REMOTE  
KEYLESS  
ENTRY  
MODULE**  
PAGE 111-1

**INSTRUMENT  
CLUSTER**  
PAGES 60-1, 60-3, 60-7, 64-1

**REAR ANTI-  
LOCK BRAKES  
(RABS)  
MODULE**  
PAGE 42-1

**ELECTRONIC  
SHIFT  
CONTROL  
MODULE**  
PAGE 34-1

**AIR BAG DIAGNOSTIC MONITOR**  
PAGE 46-1

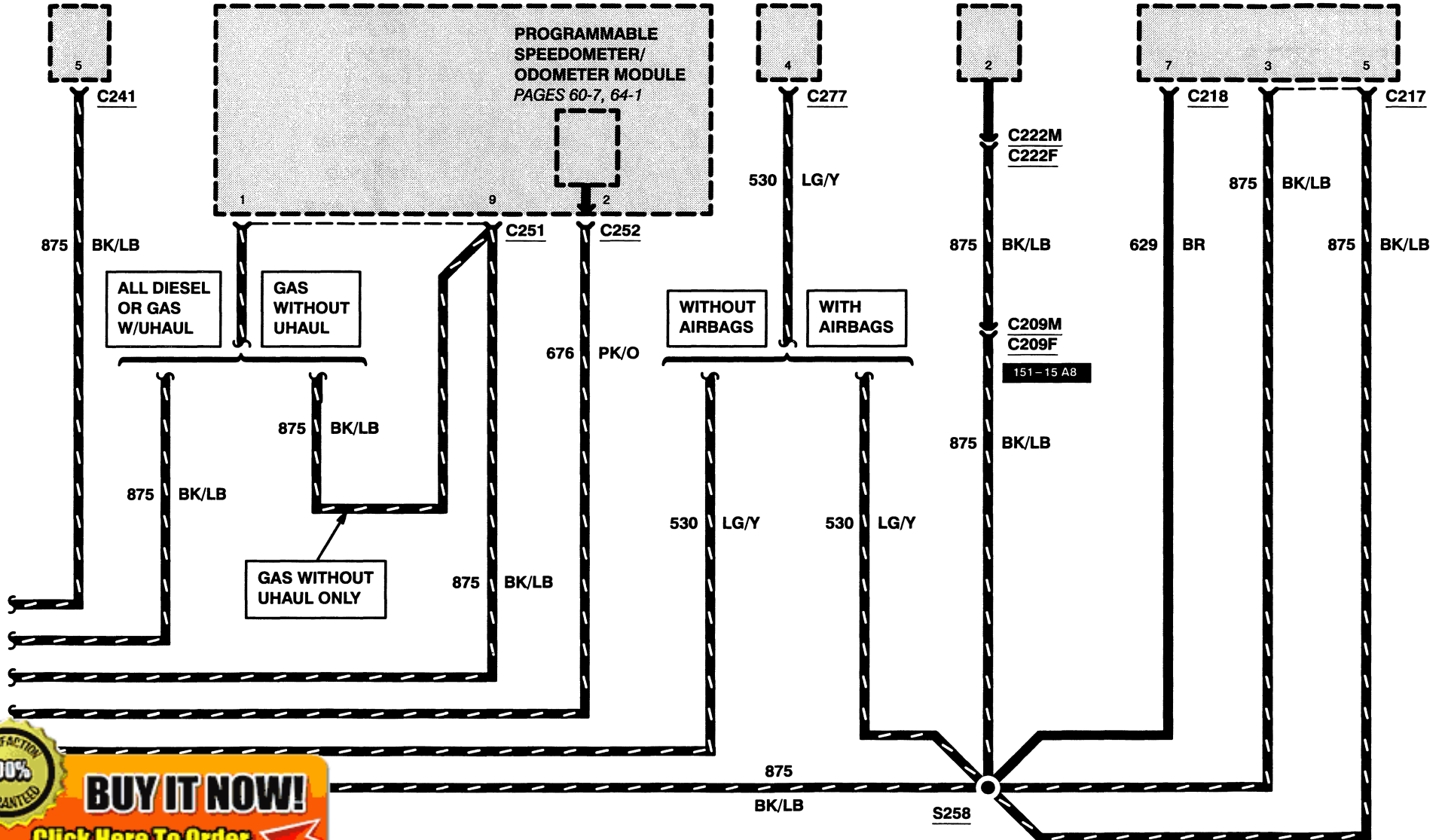

**100% SATISFACTION GUARANTEED**

**BUY IT NOW!**

**Click Here To Order**

PayPal    American Express    Discover    MasterCard    VISA

# 10-11 GROUNDS

1996 F-SERIES

**ALL DIESEL WITH  
TRACTION ASSIST**

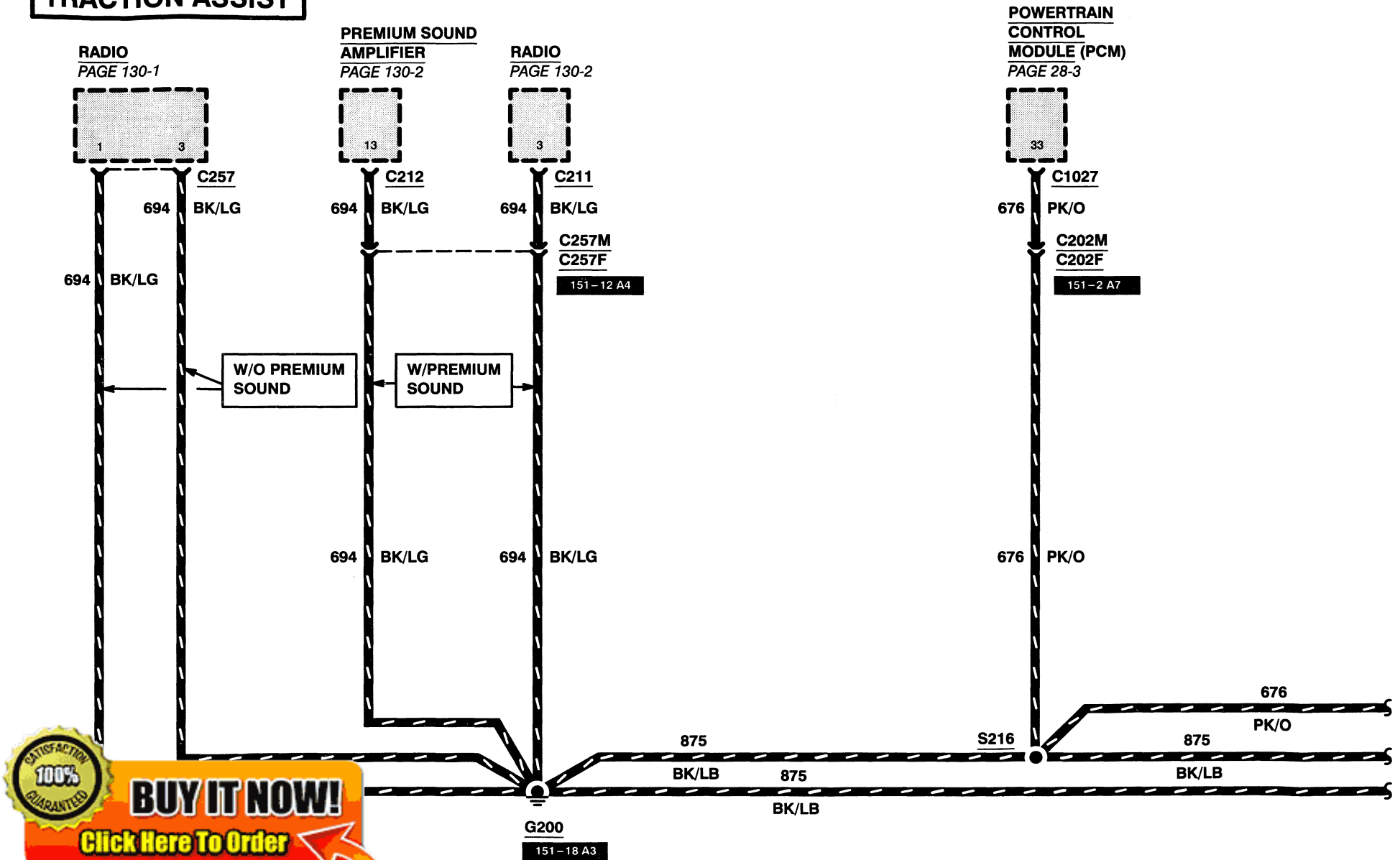

**BUY IT NOW!**

[Click Here To Order](#)



**INSTRUMENT CLUSTER**  
PAGES 60-1, 60-3, 60-7, 64-1

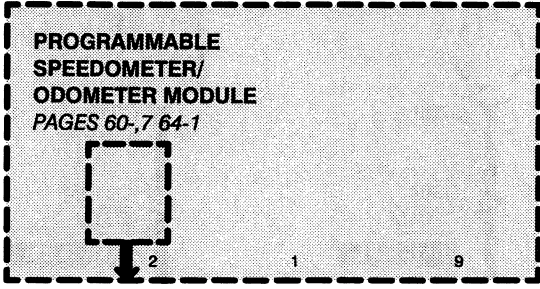

**REMOTE KEYLESS ENTRY MODULE**  
PAGE 111-4

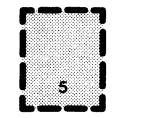

**REAR ANTI-LOCK BRAKES (RABS) MODULE**  
PAGE 42-1

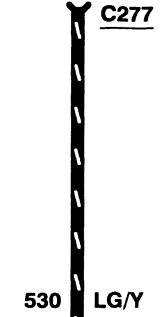
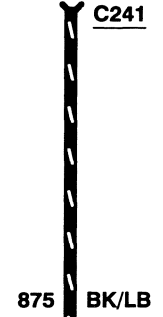
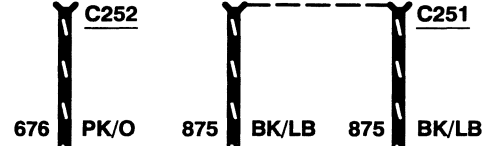
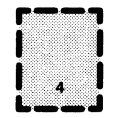

**100% SATISFACTION GUARANTEED**

**BUY IT NOW!**

Click Here To Order

PayPal, American Express, Discover, MasterCard, VISA

# 10-13 GROUNDS

1996 F-SERIES

All circuits are 57 (BK) unless otherwise noted.

SEAT BELT SWITCH  
PAGE 66-1

CARGO/HIGH MOUNT STOP LAMPS  
PAGES 89-2, 89-5

RIGHT REAR DOOR COURTESY LAMP  
PAGES 89-2, 89-5

LEFT REAR DOOR COURTESY LAMP  
PAGES 89-2, 89-5

LEFT POWER LUMBAR COMPRESSOR MOTOR  
PAGE 122-1

RIGHT POWER LUMBAR COMPRESSOR MOTOR  
PAGE 122-1

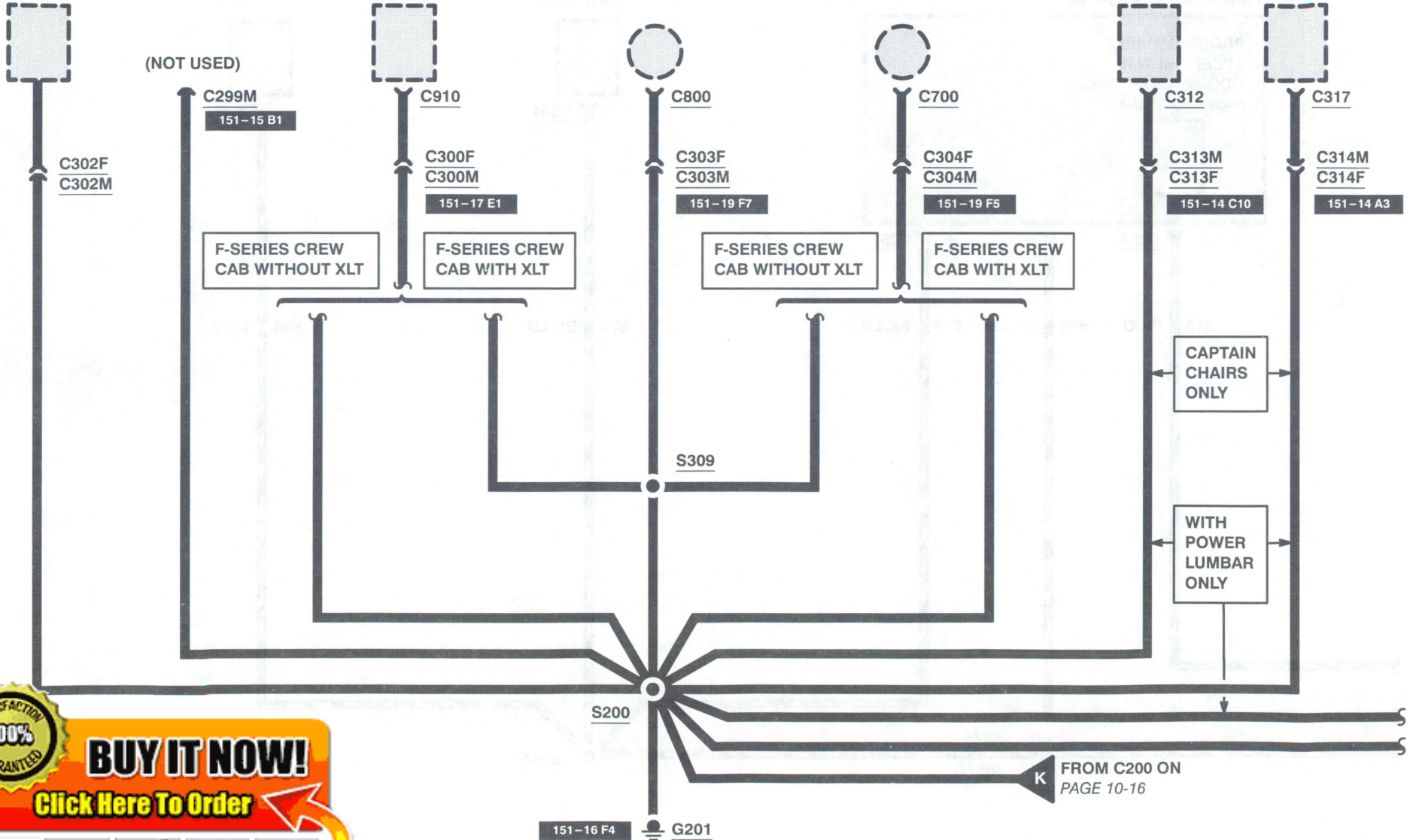

**BUY IT NOW!**

Click Here To Order



**LEFT POWER  
LUMBAR/  
BOLSTER  
COMPRESSOR  
MOTOR**  
PAGE 122-3

**RIGHT POWER  
LUMBAR/  
BOLSTER  
COMPRESSOR  
MOTOR**  
PAGE 122-3

**MASTER WINDOW/  
DOOR LOCK  
CONTROL SWITCH**  
PAGES 100-1, 100-2,  
110-1, 110-2, 111-1

\* WITHOUT CREW CAB  
\*\* WITH KEYLESS ENTRY

**LEFT FRONT DOOR  
COURTESY LAMP**  
PAGES 89-1, 89-5

**POWER  
MIRROR  
SWITCH**  
PAGE 124-1

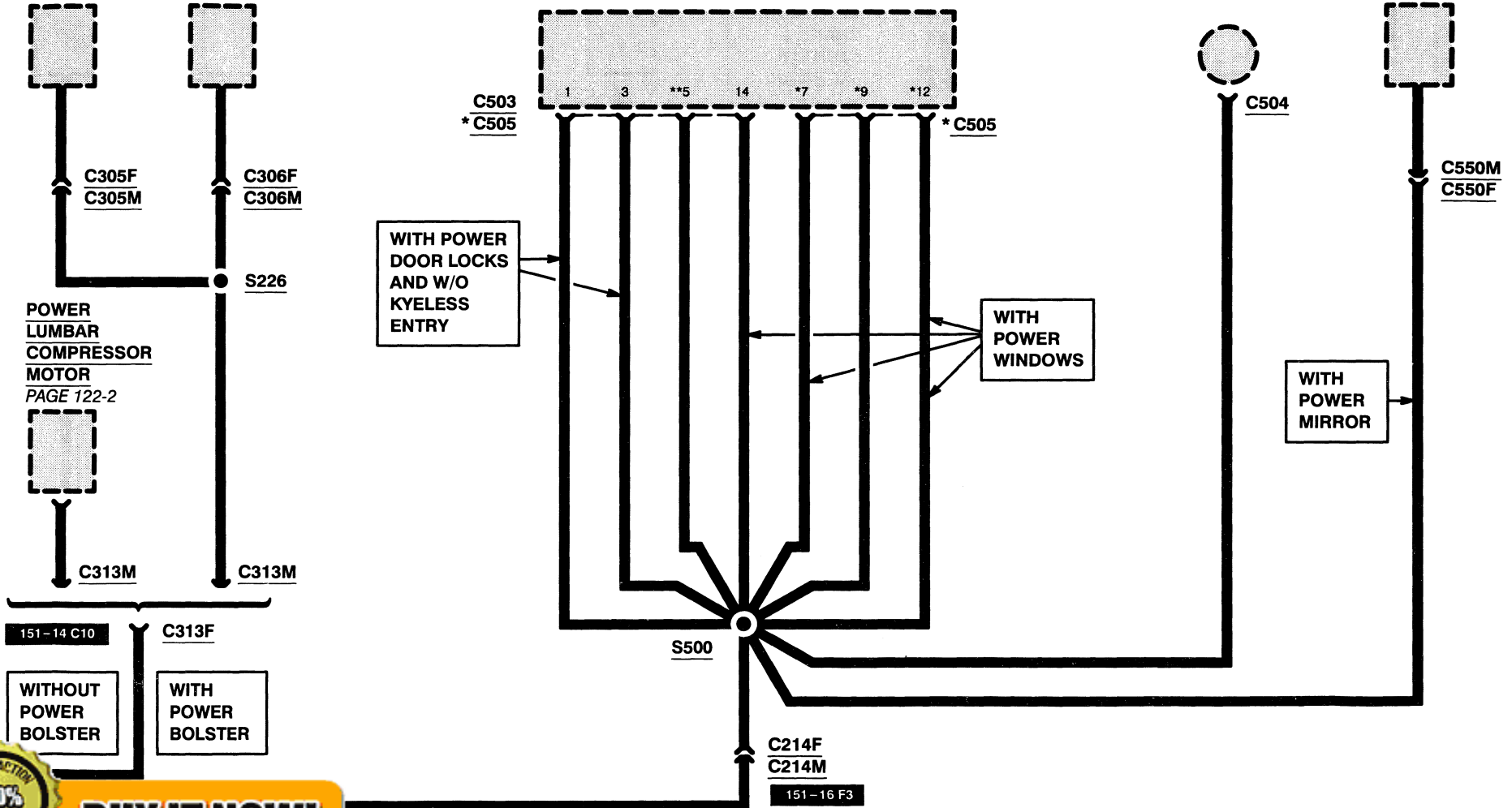

**100% SATISFACTION GUARANTEED**

**BUY IT NOW!**

**Click Here To Order**

# 10-15 GROUNDS

1996 F-SERIES

All circuits are 57 (BK) unless otherwise noted.

**CAB MARKER LAMPS**  
PAGE 92-4

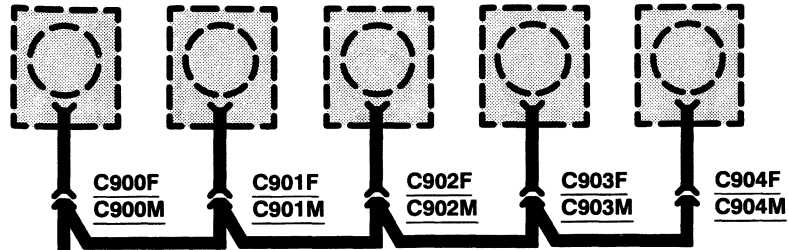

C201F  
C201M  
151-16 F6

**WIPER CONTROL MODULE**  
PAGE 81-1

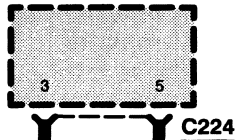

**RIGHT DOOR LOCK CONTROL SWITCH**  
PAGE 111-1

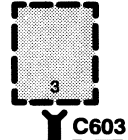

**RIGHT FRONT DOOR COURTESY LAMP**  
PAGES 89-1, 89-4



W/REMOTE KEYLESS ENTRY ONLY

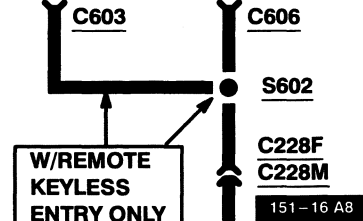

**TRAILER ELECTRONIC BRAKE CONTROL**  
PAGE 95-3

206 W

C210F  
C210M  
151-12 F2

WITH TRAILER TOW ONLY

DIESEL ONLY

**CIGAR LIGHTER**  
PAGE 44-1

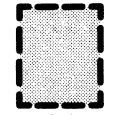

**AUXILIARY POWER SOCKET**  
PAGE 44-1

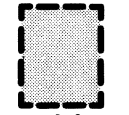

**ASHTRAY ILLUMINATION**  
PAGE 71-1

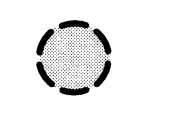

**BLOWER MOTOR RESISTOR**  
PAGES 53-2, 54-2, 54-5

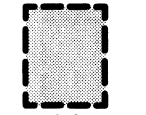

**ELECTRONIC SHIFT CONTROL MODULE**  
PAGE 34-1

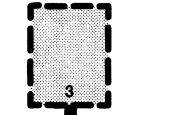

C222M  
C222F

C209M  
C209F  
151-15 A8

WITH ELECTRONIC SHIFT CONTROL

C204M  
C204F

C203F  
C203M  
151-16 A7

**DATA LINK CONNECTOR (DLC)**  
151-12 E1

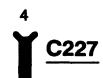

**GLOVE COMPARTMENT LAMP**  
PAGES 89-1, 89-6, 111-5

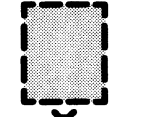

S203



**BUY IT NOW!**

Click Here To Order



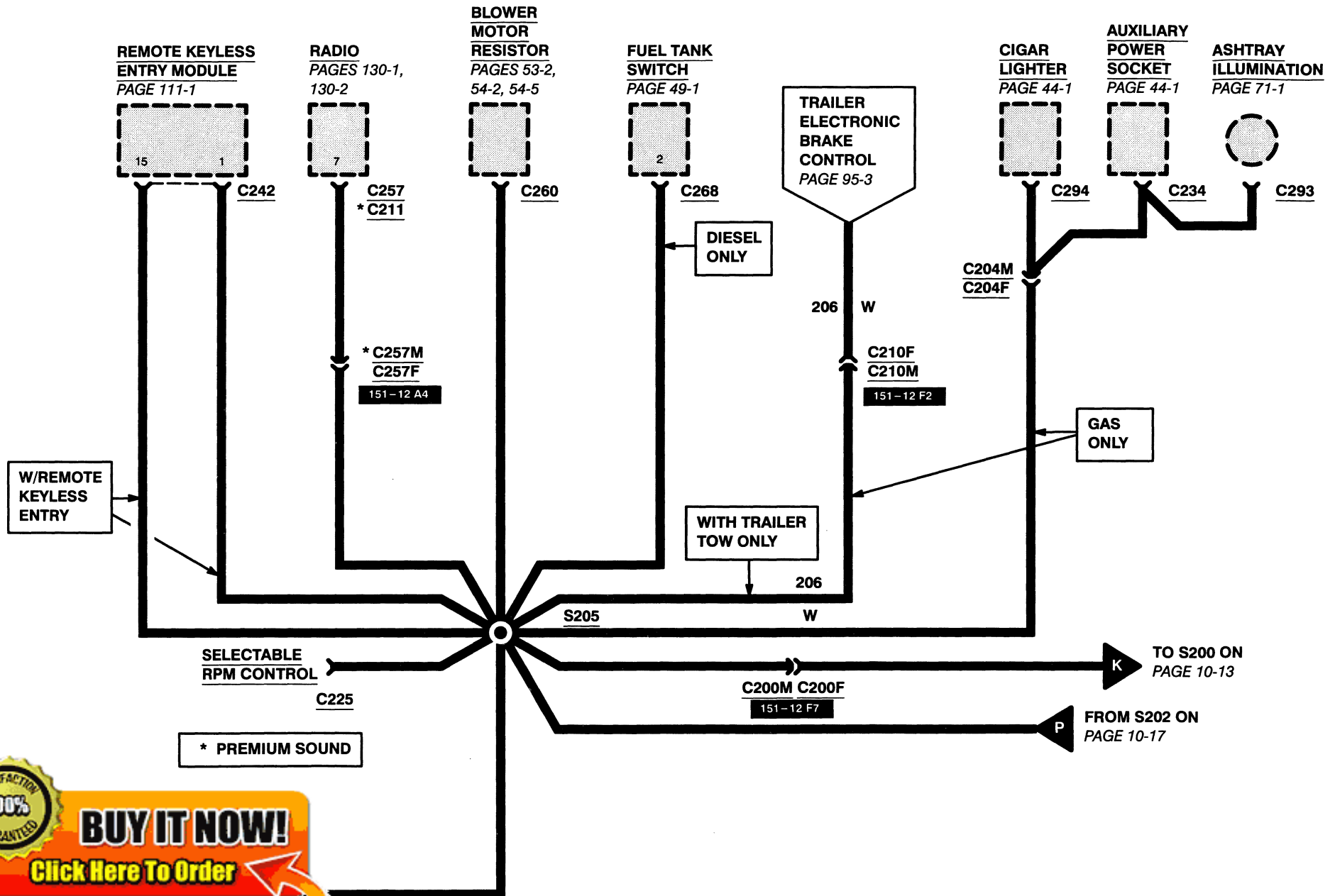

**100% SATISFACTION GUARANTEED**

**BUY IT NOW!**

Click Here To Order

PayPal

Discover

MasterCard

VISA

# 10-17 GROUNDS

1996 F-SERIES

All circuits are 57 (BK)  
unless otherwise noted.

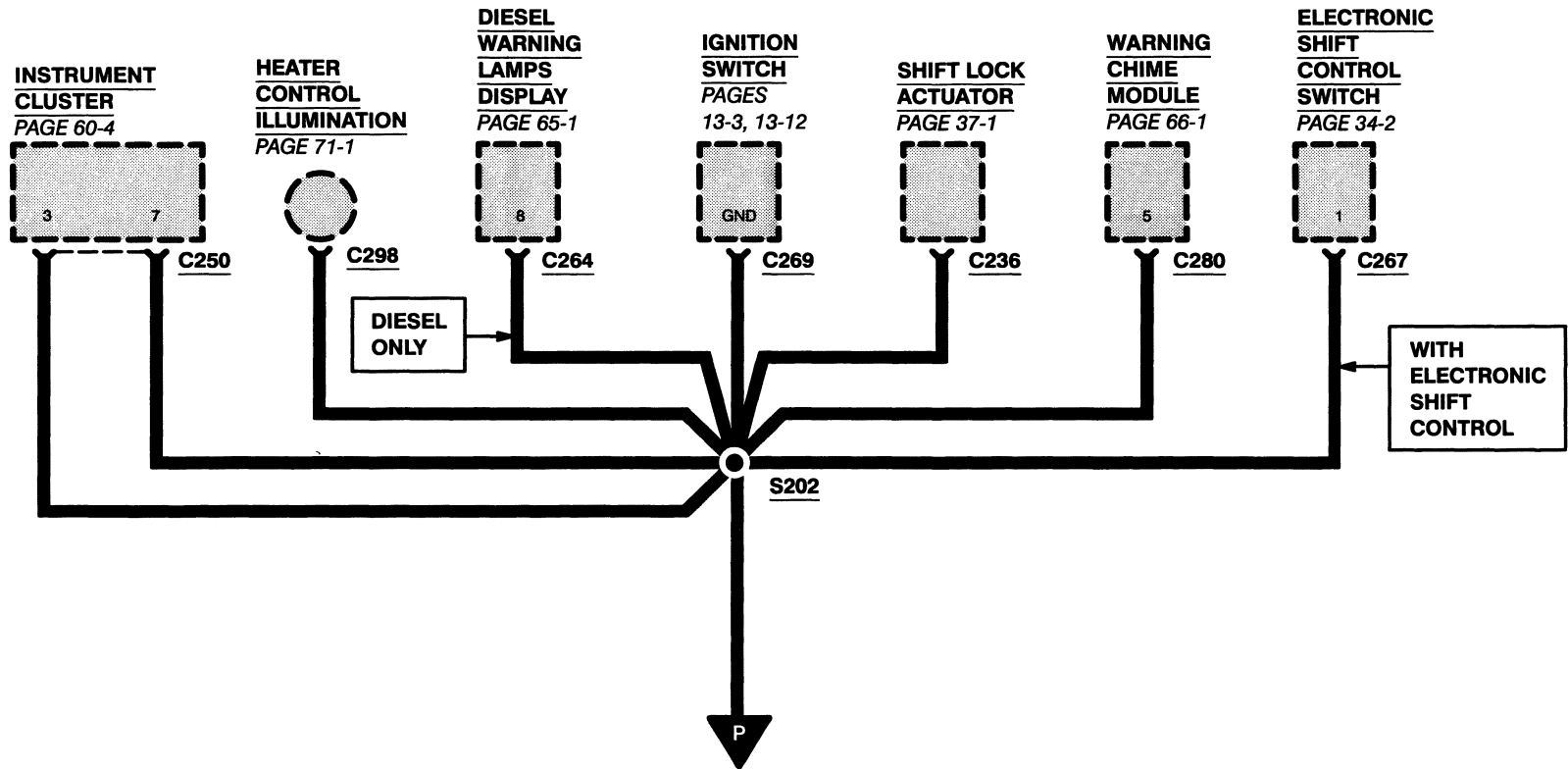

TO S205  
ON  
PAGE 10-16

Refer to Location Index, Cell 152, for  
Component, Connector, Splice, Ground and  
Base Part Number descriptions and locations.

**100% SATISFACTION GUARANTEED**

**BUY IT NOW!**

Click Here To Order

PayPal   American Express   Discover   MasterCard   VISA

# 152-39 LOCATION INDEX

1996 F-SERIES

<u>Splice</u>	<u>Location</u>
S404 (With Flare Side) .....	Rear lamp connector harness, near T/O to C401
S404 (Without Flare Side) .....	Rear lamp connector harness, near T/O to C400
S405 .....	Left lamp connector harness, near T/O to left backup lamp
S406 .....	Right rear lamp connector harness, near T/O to right backup lamp
S409 .....	Left marker lamp harness, near T/O to C412
S410 .....	Right marker lamp harness, near T/O to C420
S412 .....	Rear lamp connector harness, near T/O to C410
S417 (With Chassis Cab) .....	Rear lamp connector harness, near T/O to C448
S417 (With Flare Side) .....	Rear lamp connector harness, near T/O to C401
S417 (Without Flare Side) .....	Rear lamp connector harness, near T/O to C400
S418 .....	Rear license lamp harness, near T/O to C400
S419 .....	Rear lamps harness, near T/O to C401
S420 .....	Rear lamp connector harness, near T/O to C410
S421 .....	Left marker harness, in T/O to C412
S422 .....	Right marker lamp harness, in T/O to C420
S423 .....	Rear window regulator control harness, near T/O to tailgate window switch
S424 .....	Rear lamps harness, near T/O to license lamps
S426 .....	Rear lamp connector harness, near T/O to C401
S428 .....	Rear lamps harness, near T/O to output shaft speed sensor
S429 .....	Rear lamps harness, near T/O to output shaft speed sensor
S500 .....	Window regulator left front door harness, near T/O to master window control switch
S501 .....	Window regulator left front door harness, near T/O to C214
S502 .....	Window regulator left front door harness, near T/O to C500
S503 .....	Door window regulator control harness, near T/O to power mirror motor
S600 .....	Window regulator right front door harness, near T/O to right window control switch
S601 .....	Window regulator right front door harness, near T/O to C600
S602 .....	Window regulator right front door harness, near T/O to right window control switch
S900 .....	Rear view inside mirror harness, in windshield header
S901 .....	Rear view inside mirror harness, in windshield header
S902 .....	Rear view inside mirror harness, in windshield header



**BUY IT NOW!**  
Click Here To Order





# 153-1 HARNESS CAUSAL PART NUMBER

1996 F-SERIES

## HOW TO IDENTIFY A BASIC HARNESS NUMBER BY USING A "C" NUMBER

Understand these symbols before using the following listing:

### HARNESS TO HARNESS CONNECTION

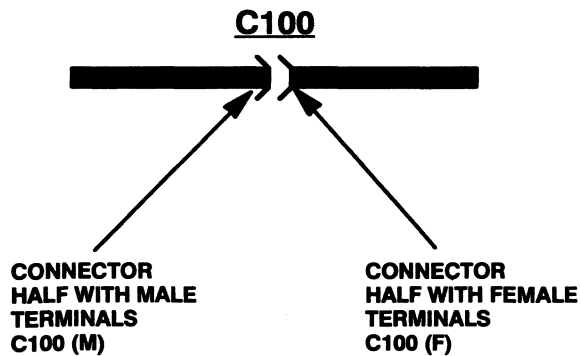

### DASHED LINES INDICATE TERMINALS OF SAME CONNECTOR

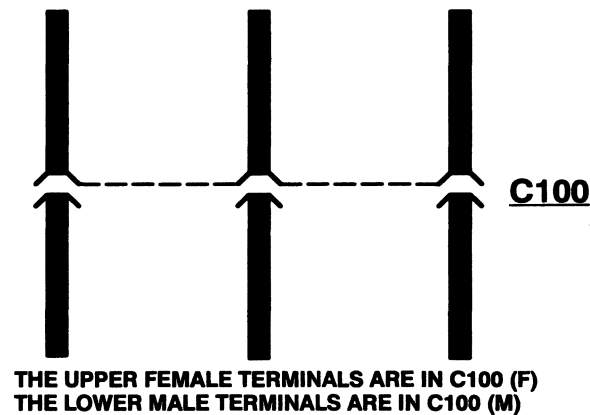

### COMPONENT CONNECTION

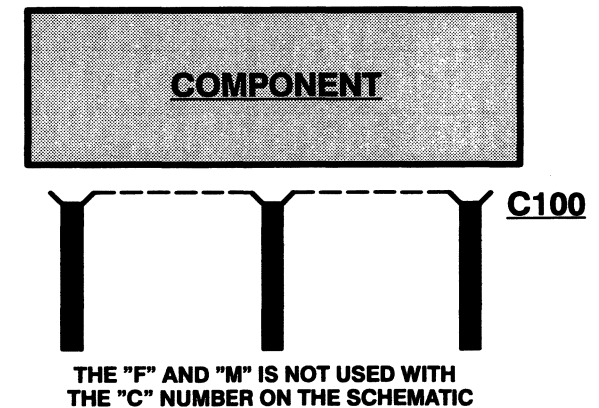

Identify the basic harness part number by:

1. Find the connector "C" number in the EVTM schematics. Then locate the "C" number in the following listing and

2. Find the connector (such as a short or a broken wire), then choose a connector located on the same harness that has the problem. Then find the connector in the following listing and read the base part number of the harness that has the problem.

# HARNES CAUSAL PART NUMBER

# 153-2

1996 F-SERIES

<u>Connector Number</u>	<u>Wire Assembly</u>	<u>Connector Number</u>	<u>Wire Assembly</u>	<u>Connector Number</u>	<u>Wire Assembly</u>	<u>Connector Number</u>	<u>Wire Assembly</u>
C101 (F)	9D930	C143 DIESEL	14401	C180 4.9L	14289	C211	19B113
C101 (M)	12A581	C143 GAS	12A581	C180	9D930	C212	19B113
C101 (F) 4.9L	14289	C144	PIA	C181	9D930	C213 (F)	14A265
C102	12A581	C145	PIA	C182	9D930	C213 (M)	14A509
C103 (F)	15525	C146	PIA	C182 4.9L	14289	C214 (F)	14A509
C103 (M)	12A581	C149 (F)	14A346	C183	9D930	C214 (F) **	19A123
C104	12A581	C149 (M)	14405	C184	14305	C214 (M)	14A504
C105 (F)	14A346	C150	9D930	C185	12A581	C215 (F)	14A509
C105 (M)	12A581	C151	12A581	C186	PIA	C215 (M)	14A504
C106 (F)	12A581	C153	14305	C187	14305	C216	12A581
C106 (M)	18A586	C154	14305	C188	PIA	C217	14401
C107	12A581	C155	PIA	C190	9D930	C218	14401
C108 (F)	12A581	C156	PIA	C191	9D930	C219 (F)	14401
C108 (M)	14305	C158	14405	C192	9D930	C219 (M)	9C899
C110 (F)	15525	C159 (F)	14401	C193	9D930	C220 (F)	14B095
C110 (M)	12A581	C159 (M)	14401	C194	9D930	C220 (M)	PIA
C111	12A581	C161	14K067	C195	9D930	C221	14B095
C115 (F)	12A581	C162	18A586	C196	9D930	C222 (F)	14B095
C115 (M)	14305	C163	9D930	C197	9D930	C222 (M)	PIA
C116	*	C163 4.9L	14289	C198	12A581	C223	14B095
C117 (F)	14K067	C163 DIESEL	14305	C199	12A581	C224	14401
C117 (M)	15525	C164	9D930	C200 (F)	14A504	C225	14401
C118	14305	C165	14305	C200 (M)	14401	C226	14401
C125 (F)	14289	C166	15525	C201 (F)	15460	C227	14401
C125 (M)	9D930	C168	18A586	C201 (M)	14401	C228 (F)	14A265
C126 4.9L	14289	C169	18A586	C203 (F)	18A586	C228 (M)	14401
C126	9D930	C170	12A581	C203 (M)	14401	C229 (F)	14A504
C127	15525	C171	9D930	C204 (F)	14401	C229 (M)	14401
C128	12A581	C172	14305	C204 (M)	13A726	C230	14401
C130	12A581	C173 (F)	15A702	C205 (F)	14401	C231	14401
C131	12A581	C173 (M)	12A581	C205 (M)	14405	C232	14401
C135 4.9L	14289	C174	PIA	C207	14401		
	9D930	C175	PIA	C208	14401		
		C176	12A581	C209 (F)	14B095		
		C177	12A581	C209 (M)	14401		
		C178 4.9L	14289	C210 (F)	14A348		
		C178	9D930	C210 (M)	14401		

\* No Figure Available  
 \*\* W/O Power Windows

**100% SATISFACTION GUARANTEED**

**BUY IT NOW!**

**Click Here To Order**

PayPal American Express Discover MasterCard VISA

# 153-3 HARNESS CAUSAL PART NUMBER

1996 F-SERIES

Connector Number	Wire Assembly	Connector Number	Wire Assembly	Connector Number	Wire Assembly	Connector Number	Wire Assembly
C234	13A726	C295	13A726	C400 (F)	13412	C434	13A409
C235 (F)	14A504	C296	14401	C400 (M)	13A409	C435 ****	13412
C235 (M)	14401	C298	14401	C401 (F)	13A409	C435 *	13A409
C240	14401	C299 (F)	17K745	C401 (M)	14405	C436 ****	13412
C241	14401	C299 (M)	14A504	C404	14405	C436 *	13A409
C242	14401	C300 (F)	14334	C406 (F) *	14405	C440	14405
C243	14401	C300 (M)	14A504	C406 (M) *	13A409	C441 *****	14406
C244	14401	C302	14A504	C407 (F)	13A576	C441	14405
C250	14401	C303 (F)	14632	C407 (M)	14405	C446 *****	13412
C251	14401	C303 (M)	14A504	C408 (F)	13A409	C447 *****	13A409
C252	14401	C304 (F)	14632	C408 (M)	15A411	C448 *****	13A409
C257	14401	C304 (M)	14A504	C409 (F)	13A409	C500	14A509
C258	14401	C305	14B084	C409 (M)	15A411	C502	14A509
C260	14401	C306	14B084	C410 (F)	13A409	C503	14A509
C261	14401	C307 (F)	14632	C410 (M)	15425	C504	14A509
C262	14401	C307 (M)	14A504	C411	15A411	C505	14A509
C263	14A504	C308 (F)	14632	C412	15A411	C507	14A509
C264	14401	C308 (M)	14A504	C413	15A411	C507 *****	19A123
C267	14401	C310	14086	C417 (F)	12964	C508	14A509
C268	14401	C311	14086	C417 (M)	13A576	C509 (F)	14A265
C269	14401	C312	14B084	C418 (F)	14405	C509 (M)	14A509
C271	14401	C313 (F)	14A504	C418 (M)	14086	C510	14A509
C273	14401	C313 (M)	14B084	C420	15A411	C550	14A509
C274	14401	C314 (F)	14A504	C421	14405	* W/Flareside	
C275	14401	C314 (M)	14B084	C423	14405	**W/Flareside	
C276	14401	C315 (F)	14335	C424 (F)	13A576	*** W/O Flareside Chassis Cab	
C277	14401	C315 (M)	14A504	C424 (M)	14405	**** W/O Flareside W Rear	
C278	14401	C317	14B084	C427	14405	Bumper	
C279	14401	C321	14334	C428	14086	**** Chassis Cab & 185	
C280	14401	C322	14334	C429	14086	Wheelbase	
C280	AUDIO CABLE	C326	14A504	C431 **	13A409	***** W/O Flareside	
		C327	14A504	C431 ***	13A409	W/O Rear Bumper	
		C328	14B095	C432	13A409	***** Chassis Cab	
		C329	14401	C433	13A409	***** Custom & XL Trim	
		C330	12A581				

**100% SATISFACTION GUARANTEED**

**BUY IT NOW!**

**Click Here To Order**

# HARNES CAUSAL PART NUMBER

# 153-4

1996 F-SERIES

<u>Connector Number</u>	<u>Wire Assembly</u>	<u>Connector Number</u>	<u>Wire Assembly</u>	<u>Connector Number</u>	<u>Wire Assembly</u>	<u>Connector Number</u>	<u>Wire Assembly</u>
C600	14A256	C907	14334	C1017	9D930	C1037	9D930
C602	14A256	C908	14334	C1017 4.9L	14289	C1038	9D930
C603	14A256	C910	14334	C1018	PIA	C1047	PIA
C606	14A256	C911	17K745	C1019	12A581	C1048	7C078
C607	14A256	C912	17K745	C1020	15525	C1049	15525
C608	14A256	C913	17K745	C1021	12A581	C1052	12A581
C609	14A256	C1000	PIA	C1022	9D930	C1053	12A581
C700	14632	C1001	PIA	C1022 4.9L	14289	C1054	12A581
C701	14632	C1002	PIA	C1023	9D930	C1055	12A581
C702	14632	C1003 (F)	12A690	C1023 4.9L	14289	C1056	PIA
C703	14632	C1003 (M)	12A581	C1024	9D930	C1057 (F)	PIA
C704 (F)	14632	C1004	PIA	C1025	9D930	C1057 (M)	PIA
C704 (M)	14632	C1005	12A581	C1025	12A690	C1058 (F)	PIA
C800	14632	C1006	12A581	C1025 *	15525	C1058 (M)	PIA
C801	14632	C1007	9D930	C1026	9D930	C1059 (F)	PIA
C802	14632	C1007 4.9L	14289	C1026 4.9L	14289	C1059 (M)	PIA
C803	14632	C1008	9D930	C1027	12A581	C1060 (F)	PIA
C804 (F)	14632	C1008 4.9L	14289	C1029	14305	C1060 (M)	PIA
C804 (M)	14632	C1009	9D930	C1030	12A581	C1061 (M)	15525
C900	15460	C1009 4.9L	14289	C1031	12A581	C1061 (F)	7C078
C901	15460	C1010	12A581	C1032	12A581	C2000	14401
C902	15460	C1011	12A581	C1033	12A581	C2001	14401
C903	15460	C1012	15525	C1034	12A581		
C904	15460	C1013	PIA	C1035	15A702		
C905	14334	C1014	PIA	C1036	9D930		
C906	14334	C1015	PIA				

\* All 7.5L Except F450 & 5.8L over 8500 LBS

**100% SATISFACTION GUARANTEED**

**BUY IT NOW!**

**Click Here To Order**

PayPal American Express Discover MasterCard VISA

# 160-1 VEHICLE REPAIR LOCATION CODES

1996 F-SERIES

## VEHICLE REPAIR LOCATION CODES

TO PINPOINT THE ACTUAL VEHICLE LOCATION OF A REPAIR, THE VEHICLE REPAIR LOCATION CODE IS REQUIRED.

FOR EXAMPLE, AN "X" HAS BEEN PLACED IN THE QUADRANT OF THE VEHICLE DIAGRAMS INDICATING THE LOCATION OF THE REPAIR. SEE DIAGRAMS.

LOCATION CODE, FOR THE EXAMPLE: A5/FU – (UNDER THE FLOOR OF DRIVER'S LEFT FOOT.)

FRONT/REAR DIRECTION

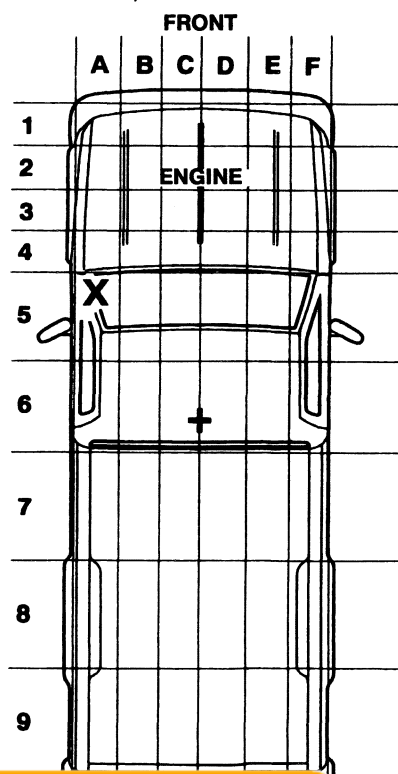

OVER/UNDER DIRECTION

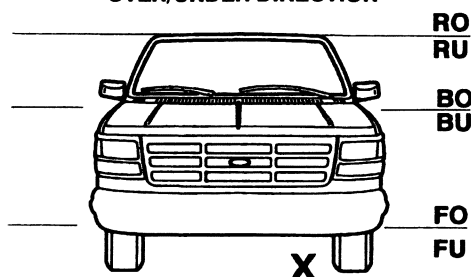

- R = ROOF LINE
- RO = ROOF OVER
- RU = ROOF UNDER
- B = BELT LINE
- BO = BELT OVER
- BU = BELT UNDER
- F = FLOOR PAN
- FO = FLOOR OVER
- FU = FLOOR UNDER

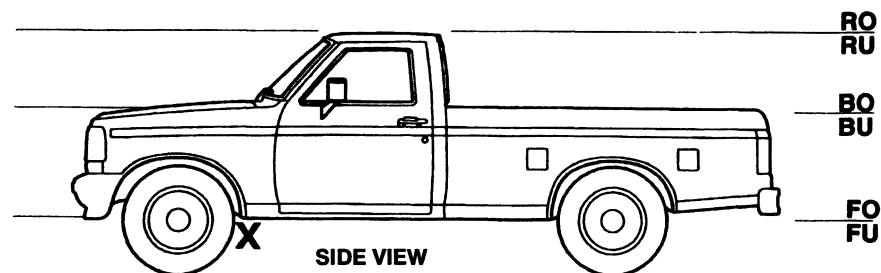

F-SERIES  
FCS-12254-96



**BUY IT NOW!**

Click Here To Order





TECHNICAL  
PUBLICATIONS DEPARTMENT  
Ford Customer Service Division



FCS-12254-96

COPYRIGHT © 1995  
FORD MOTOR COMPANY

JUNE 1995

LITHO IN U.S.A.