

1981 BRONCO / F100 / 350 / COURIER

electrical & vacuum trouble- shooting manual

DEMO

This DEMO contains only a few pages of the entire manual/product.

Not all Bookmarks work on the Demo, but they do on the full version.

Features:

- Searchable text
- Printable pages
- Bookmarked for easy navigation
- High Resolution images
- Zoom to see exact details
- Money back Guarantee
- Available on USB and eBook download

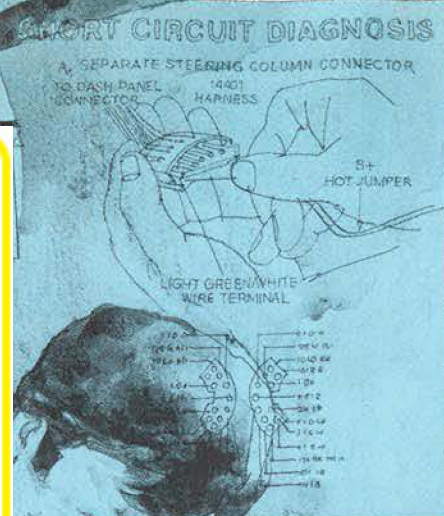

1981 BRONCO F100/350 COURIER



100% SATISFACTION GUARANTEED

BUY IT NOW!

[Click Here To Order](#)

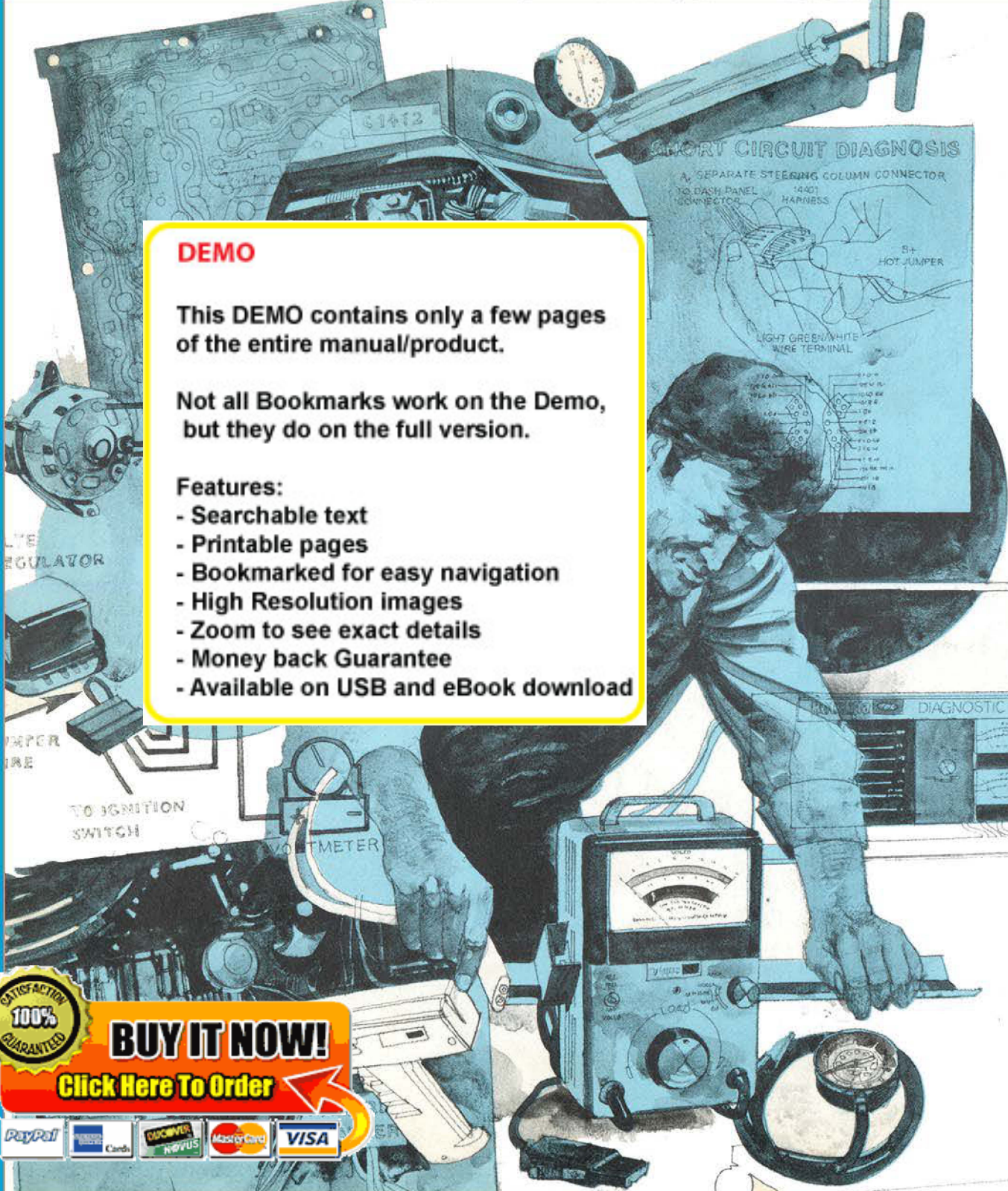

Copyright © 2023, Forel Publishing Company, LLC, Woodbridge, Virginia

All Rights Reserved. No part of this book may be used or reproduced in any manner whatsoever without written permission of Forel Publishing Company, LLC. For information write to Forel Publishing Company, LLC, Woodbridge, VA 22192

1981 Bronco F-100/F-350 Courier Electrical & Vacuum Trouble-Shooting Manual (EVTM)

EAN: 978-1-60371-404-4

ISBN: 1-60371-404-9

Forel Publishing Company, LLC
Woodbridge, VA 22192
Email: sales@ForelPublishing.com
<https://www.ForelPublishing.com>



License #84356800

This publication contains material that is reproduced and distributed under a license from Ford Motor Company. No further reproduction or distribution of the Ford Motor Company material is allowed without the express written permission of Ford Motor Company.

Note from the Publisher

This product was created from the original Ford Motor Company's publication. Every effort has been made to use the original scanned images, however, due to the condition of the material; some pages have been modified to remove imperfections.

Disclaimer

Although every effort was made to ensure the accuracy of this book, no representations or warranties of any kind are made concerning the accuracy, completeness or suitability of the information, either expressed or implied. As a result, the information contained within this book should be used as general information only. The author and Forel Publishing Company, LLC shall have neither liability nor responsibility to any person or entity with respect to any loss or damage caused, or alleged to be caused, directly or indirectly by the information contained in this book. Further, the publisher and author are not engaged in rendering legal or other professional services. If legal, mechanical, electrical, or other expert assistance is required, the assistance of a professional should be sought.



CONTENTS

How to Use This Manual	2
Symbols (Electrical)	3
(Vacuum)	94
How to Find the Electrical Problem ...	4
How to Find the Vacuum Problem	93
Component Testing (Bronco/F Series Only)	
Introduction	95
Light Switch	95
Ignition Switch	96
Turn Switch	97
Windshield Wiper/Washer Switch ..	98
Interval Wiper/Washer Switch	99
A/C-Heat Function Control	100
A/C-Heat Blower Switch	101

.....

BRONCO, F100-F350 INDEX

A/C-Heat	82
Auxiliary Battery	17
Auxiliary Heater	80
Brake Warning Indicator	56
Camper	88
Carburetor Circuits	21
Charge (With Alternator Warning Indicator)	12
Charge (With Ammeter)	14
Choke Heater	21
Cigar Lighter	68
Clock	70
Comfort Vent Heater	84
Coolant Temperature Gage	58
Digital Clock	70
Electronic Engine Control	32
Feedback Carburetor Control (EEC)	32
Feedback Carburetor Control (MCU)	30
Four-Wheel Drive Indicator	90
Fuel Gage	58
Fuel Tank Selector	58
Fuse Block	10
Gages Cluster	58
Grounds	6
Headlights	38
Heater	80
Horn	66
Ignition	18
Instrument Cluster	54
Instrument Illumination	54
Lights On Warning	52
Lights	
Backup	46
Brake Warning Indicator	56
Cargo	51
Dome	51
Lights (continued)	
Exterior	40
Fog	43
Hazard	48
Headlights	38
Instrument Illumination	54
License	41
Map	52
Marker	40, 41
Park	40, 41
Radio Illumination	54
Stop	48
Tail (Rear Park)	48, 49
Turn	48
Light Switch	30
MCU	30
Power Distribution	12
Power Door Locks	74
Power Windows	72
Printed Circuit Board Connector	
With Ammeter (C208A)	54
With Indicator (C208)	54
Radio (Mono)	76
(Stereo)	77
Rear Window Deice	64
Seatbelt Warning	56
Speed Control	66
Start	18
Tailgate Power Window	64
Trailer	88
Vacuum Distribution	94
Warning Indicators	56
Windshield Wiper/Washer	60
Wiper/Washer (Interval)	62



BUY IT NOW!
Click Here To Order







COURIER INDEX

A/C-Heat	234	(Lights continued)	
Brake Warning Indicator	230	Hazard	222
Carburetor Circuits	212, 214	Headlights	21
Charge	204	Instrument Illumination	228
Choke Heater	214	License	218
Cigar Lighter	225	Marker	218
Coolant Temperature Gage	230	Park	218
Fuel Gage	230	Radio Illumination	228
Fuse Block	203	Stop	222
Gages Cluster	230	Tail (Rear Park)	218
Grounds	200	Turn	222
Headlights	216	Light Switch	205
Heater	234	Power Distribution	204
Horn	225	Printed Circuit Board Connector	
Ignition	208	With Ammeter (C211)	228
Instrument Cluster	228	With Indicator (C301)	228
Instrument Illumination	228	Radio	232
Lights		Rear Window Deice	232
Backup	220	Seatbelt Warning	220
Brake Warning Indicator	230	Start	208
Dome	225	Trailer	88
Exterior	218	Warning Indicators	230
		Windshield Wiper/Washer	225

IMPORTANT SAFETY NOTICE

Appropriate service methods and proper repair procedures are essential for the safe, reliable operation of all motor vehicles, as well as the personal safety of the individual doing the work. This Manual provides general directions for accomplishing service and repair work with tested, effective techniques. Following them will help assure reliability.

There are numerous variations in procedures, techniques, tools, and parts for servicing vehicles, as well as in the skill of the individual doing the work. This Manual cannot possibly anticipate all such variations and provide advice or cautions as to each. Accordingly, anyone who departs from the instructions provided in this Manual must first establish that he compromises neither his personal safety nor the vehicle integrity by his choice of methods, tools or parts.

100% SATISFACTION GUARANTEED

BUY IT NOW!

Click Here To Order

PayPal American Express Discover MasterCard VISA

2 HOW TO USE THIS MANUAL

The **Purpose** of this manual is to show electrical and vacuum circuits of these vehicles in a clear and simple fashion to make troubleshooting easier. With each circuit is a description of *How the Circuit Works*, and some *Troubleshooting Hints*. A *Component Location* chart lists components, connectors and grounds in that circuit. The chart includes a description of where each item is located, and references to pictures in the manual.

Wiring Diagrams give a schematic picture of when and how the circuit is powered, what the current path is to circuit components, and how the circuit is grounded. Each circuit component is named (underlined titles) and wire colors are listed.

WIRE COLOR ABBREVIATIONS

BL	Blue	N	Natural
BK	Black	O	Orange
BR	Brown	PK	Pink
DB	Dark Blue	P	Purple
DG	Dark Green	R	Red
GR	Green	T	Tan
GY	Gray	W	White
LB	Light Blue	Y	Yellow
LG	Light Green		

Where two colors are shown for a wire, the first color is the basic color of the wire. The second color is the dot, hash, or stripe marking. If **D** or **H** is given, the second color is dots or hash marks. If there is no letter after the second color, the wire has a stripe.

For example:

BO is a brown wire with an orange stripe
BD is a brown wire with orange dots.
BOH is a brown wire with orange dots and a white hash

Components which work together are shown together. For example, all electrical components used in any circuit are shown on one diagram. The circuit breaker or fuse is shown at the top of the page. All wires, connectors, splices, switches, and motors are shown in the flow of current to ground at the bottom of the page. Notes are included which describe how switches and other components work. If a component is used in several different circuits, it is shown in several places. For example, the **Light Switch** is an electrical part of many circuits, and is repeated on many pages. In some cases, however, a component may seem by its name to belong on a page where it has no electrical connection. For example, **Radio Illumination** is electrically part of **Instrument Illumination**. Since it has no electrical connection at all with the actual **Radio** circuit, it is not shown on the **Radio** page.

Troubleshooting Hints point the technician in a general direction, but are not intended as a step-by-step procedure. Ignition troubleshooting is an exception to this. It includes a step-by-step procedure of basic quick checks to locate some of the more common **Ignition System** problems. Read the Shop Manual for more detailed repair procedures.

The **Grounds** pages show detailed views of multiple component ground points. This is useful for checking interconnections among the ground circuits of different diagrams.

Notes, Cautions and **Warnings** appear in boxes on text pages and contain important car and mechanic safety information.

Notes give added information to help complete a particular procedure. Cautions are included to prevent making an error that could damage the vehicle. Warnings highlight areas

where carelessness can cause personal injury. The following list contains some general **Warnings** that should be followed when working on a vehicle.

- Always wear safety glasses for eye protection.
- Use safety stands whenever a procedure requires being under a vehicle.
- Be sure that the **Ignition Switch** is always in the OFF position, unless otherwise required by the procedure.
- Set the parking brake when working on any vehicle. An automatic transmission should be in PARK. A manual transmission should be in NEUTRAL.
- Operate the engine only in a well-ventilated area to avoid the danger of carbon monoxide.
- Keep away from moving parts when the engine is running, especially the fan and belts.
- To prevent serious burns, avoid contact with hot metal parts such as the radiator, exhaust manifold, tail pipe, catalytic converter and muffler.
- Do not allow flame or sparks near the battery. Gases are always present in and around the battery cell. An explosion could occur.
- Do not smoke.
- To avoid injury, always remove rings, watches, loose hanging jewelry, and loose clothing.

100% SATISFACTION GUARANTEED

BUY IT NOW!

Click Here To Order

PayPal American Express Cards Discover Novus MasterCard VISA

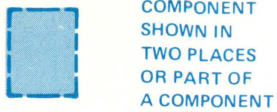

COMPONENT SHOWN IN TWO PLACES OR PART OF A COMPONENT



COMPONENT WITH CONNECTORS

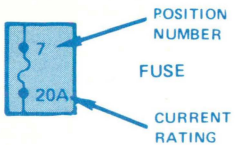

POSITION NUMBER
FUSE
CURRENT RATING

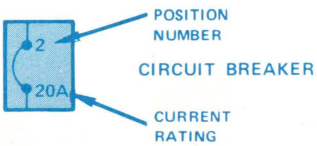

POSITION NUMBER
CIRCUIT BREAKER
CURRENT RATING



SCREW TERMINAL ON COMPONENT

SEALED ELECTRONIC COMPONENT ANY CIRCUITRY SHOWN INSIDE THE

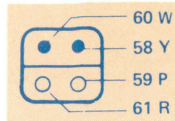

WIRE COLORS ARE LABELED FOR MATING HARNESS CONNECTOR

COMPONENT CONNECTOR END VIEW SHOWS PINS OR SOCKETS ON A COMPONENT TO AID IN BENCH TESTING

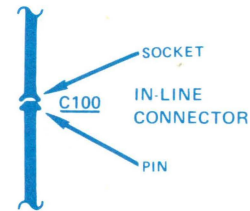

SOCKET
IN-LINE CONNECTOR
PIN



SPLICE OR CRIMP TERMINAL



GROUND CONNECTION



FUSE LINK



SOLID WIRE



STRIPED WIRE



DOTTED WIRE



HASHED WIRE

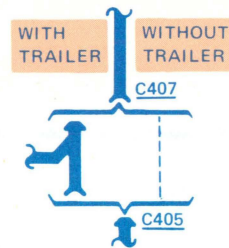

ALTERNATE CIRCUIT PATH OR OPTIONAL WIRING BRACKETS
DASHED LINE MEANS C405 CONNECTS DIRECTLY TO C407 WITHOUT TRAILER



CANDELABRA CONNECTOR ACCEPTS SINGLE-PIN CONNECTORS



JUNCTION BLOCK

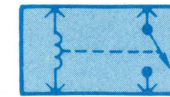

RELAY CONTACTS CLOSE WITH CURRENT THROUGH COIL

DASHED LINE SHOWS MECHANICAL CONNECTIONS



DIODES CURRENT FLOWS IN DIRECTION OF ARROW ONLY

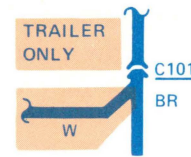

OPTIONAL WIRING RUBY BR WIRE IS ON ALL VEHICLES BUT WIRE W IS NOT

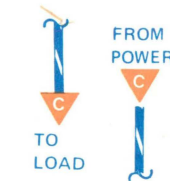

"CUT" WIRES REFERENCED BETWEEN PAGES ARROWS SHOW CURRENT FLOW FROM POWER TO GROUND



"REFERENCE" WIRES COMPLETE WIRING SHOWN ON ANOTHER PAGE

20

REFERENCE NUMBER REPEATED AT EACH POINT CIRCUITRY REPEATS OR OVERLAPS

SEE GROUNDS, PAGE 6 OR 7

A DASHED WIRE INDICATES THAT THE CIRCUITRY IS NOT SHOWN IN COMPLETE DETAIL, BUT IS COMPLETE ON ANOTHER PAGE.

100% SATISFACTION GUARANTEED

BUY IT NOW!

Click Here To Order

4 HOW TO FIND THE ELECTRICAL PROBLEM

TROUBLESHOOTING STEPS

These six steps present an orderly method of troubleshooting:

Step 1. Verify the problem.

- Operate the complete system and see all symptoms for yourself in order to:
 - check the accuracy and completeness of the customer's complaint.
 - learn more that might give a clue to the nature and location of the problem.

Step 2. Narrow the problem.

- Using the EVTM, narrow down the possible causes and locations of the problem in order to more quickly find the exact cause.
- Read the description of *How the Circuit Works* and study the wiring diagram. You should then know enough about the circuit operation to figure out where to check for this trouble.

Step 3. Test the cause.

- Use electrical test procedures to find the specific cause of the symptoms.
- *Troubleshooting Hints* will give some helpful ideas.
- The *Component Location* charts and the pictures will help you find components, grounds, and connectors.

Step 4. Verify the cause.

- Confirm the fact that you have found the correct cause through operating the parts of the circuit you think are good.

Step 5. Make the repair.

- Repair or replace the faulty component.

Step 6. Verify the repair.

Operate the system as in Step 1 and check that your repair has removed all symptoms, and any new

and special test
res. See the
books for

details. You will find the circuits in this manual to be helpful with these special tests:

TROUBLESHOOTING TOOLS

JUMPER WIRE

This is a test lead used to connect two points of a circuit. A **Jumper Wire** can complete a circuit by bypassing an open.

Uses: Bypassing Switches or Open Circuits

WARNING

Never use a jumper wire across loads (motors, etc.) connected between hot and ground. This direct battery short may cause injury or fire.

VOLTMETER

A DC **Voltmeter** measures circuit voltage. Connect negative (- or black) lead to ground, and positive (+ or red) lead to voltage measuring point.

OHMMETER

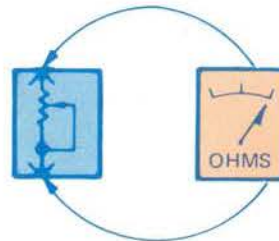

Figure 1— Resistance Check

An **Ohmmeter** shows the resistance between two connected points (Figure 1).

TEST LIGHT

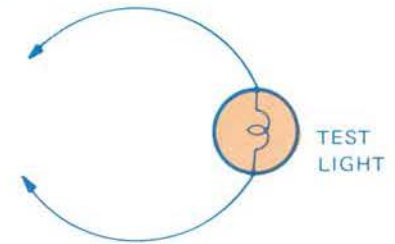

Figure 2— Test Light

A **Test Light** is a 12-volt bulb with two test leads (Figure 2).

Uses: Voltage Check. Short Check

SELF-POWERED TEST LIGHT

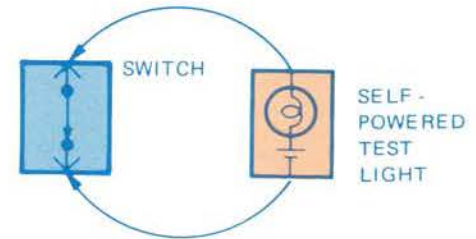

Figure 3— Continuity Check

The **Self-Powered Test Light** is a bulb, battery and set of test leads wired in series (Figure 3). When connected to two points of a continuous circuit, the bulb glows.

Uses: Continuity Check. Ground Check

CAUTION

When using a self-powered test light or ohmmeter, be sure power is off in circuit during testing. Hot circuits can cause equipment damage and false readings.

100% SATISFACTION GUARANTEED

BUY IT NOW!

Click Here To Order

PayPal American Express Discover MasterCard VISA

TROUBLESHOOTING CHECKS

SWITCH CIRCUIT CHECK

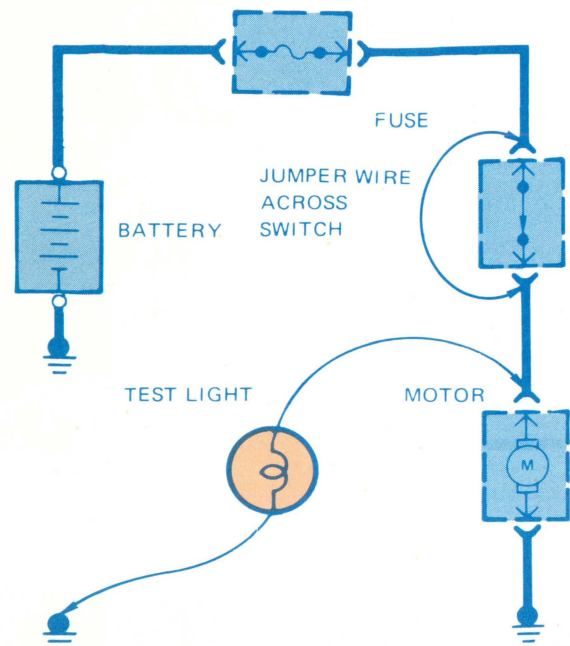

Figure 4—Switch Circuit Check and Voltage Check

In a bad circuit with a switch in series with the load, jumper the terminals of the switch to power the load. If jumping the terminals powers the circuit, the switch is bad (Figure 4).

CONTINUITY CHECK (Locating open circuits)

Connect one lead of **Self-Powered Test Light** or **Ohmmeter** to each end of circuit (Figure 3). Light will glow if circuit is closed. Switches and fuses can be checked in the same way.

VOLTAGE CHECK

to a known
(-) battery
of the other
when the

SHORT CHECK (short to ground)

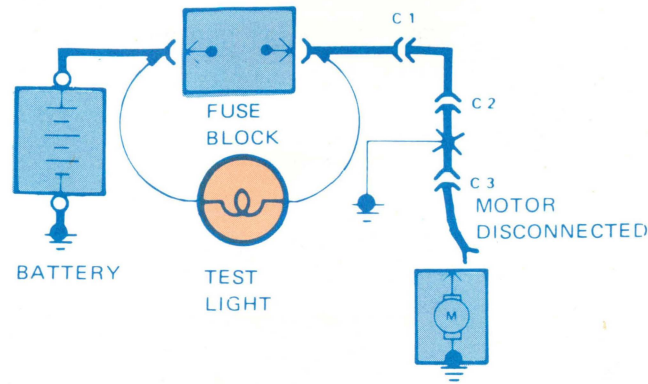

Figure 5—Short Check

A fuse that repeatedly blows is usually caused by a short to ground. It's important to be able to locate such a short quickly (Figure 5).

- 1) Turn off everything powered through the fuse.
- 2) Disconnect other loads powered through the fuse:
 - Motors: disconnect motor connector.
 - Lights: remove bulbs.
- 3) Turn **Ignition Switch** to RUN (if necessary) to power fuse.
- 4) Connect one **Test Light** lead to hot end of blown fuse. Connect other lead to ground. Bulb should glow showing power to fuse. *(This step is just a check to be sure you have power to the circuit.)*
- 5) Disconnect the **Test Light** lead from ground and reconnect it to the load side of the fuse.
 - If the **Test Light** is off, the short is in the disconnected equipment.
 - If the **Test Light** goes on, the short is in the wiring. You must find the short by disconnecting the circuit connectors one at a time until the **Test Light** goes out. For example: with a ground at X, the bulb goes out when C1 or C2 is disconnected, but stays on after disconnecting C3. This

means the ground is between C2 and C3.
"GOOD GROUND" CHECK

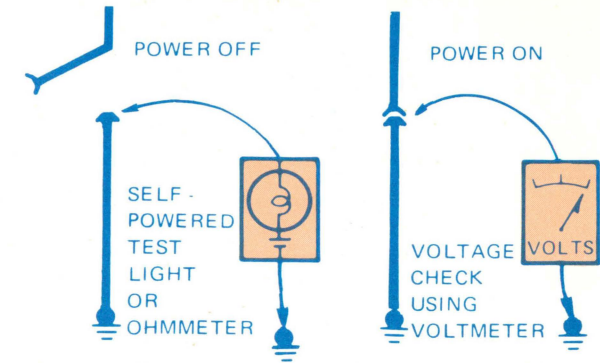

Figure 6 — Grounds Checks

Turn on power to circuit. Perform Voltage Check between suspected bad ground and frame. Any voltage means ground is bad.

Turn off power to circuit. Connect one lead of **Self-Powered Test Light** or **Ohmmeter** to wire in question, and the other to known ground. If bulb glows, circuit ground is OK (Figure 6).

TROUBLESHOOTING HINTS

The circuit schematics in this manual are designed to make it easy to identify common points in circuits. This knowledge can help narrow the problem to a specific area. For example, if several circuits fail at the same time, check for a common power or ground connection. (See *Power Distribution* or *Grounds*). If part of a circuit fails, check the connections between the part that works and the part that doesn't work.

For example, if low beam headlights work, but high beams and the indicator light don't work, then power and ground paths must be good. Since the dimmer switch is the component which switches this power to the high beam lights and indicator, it is most likely the cause of failure.

100% SATISFACTION GUARANTEED

BUY IT NOW!

Click Here To Order

PayPal, American Express, Discover, MasterCard, VISA

INSTRUMENT PANEL GROUND

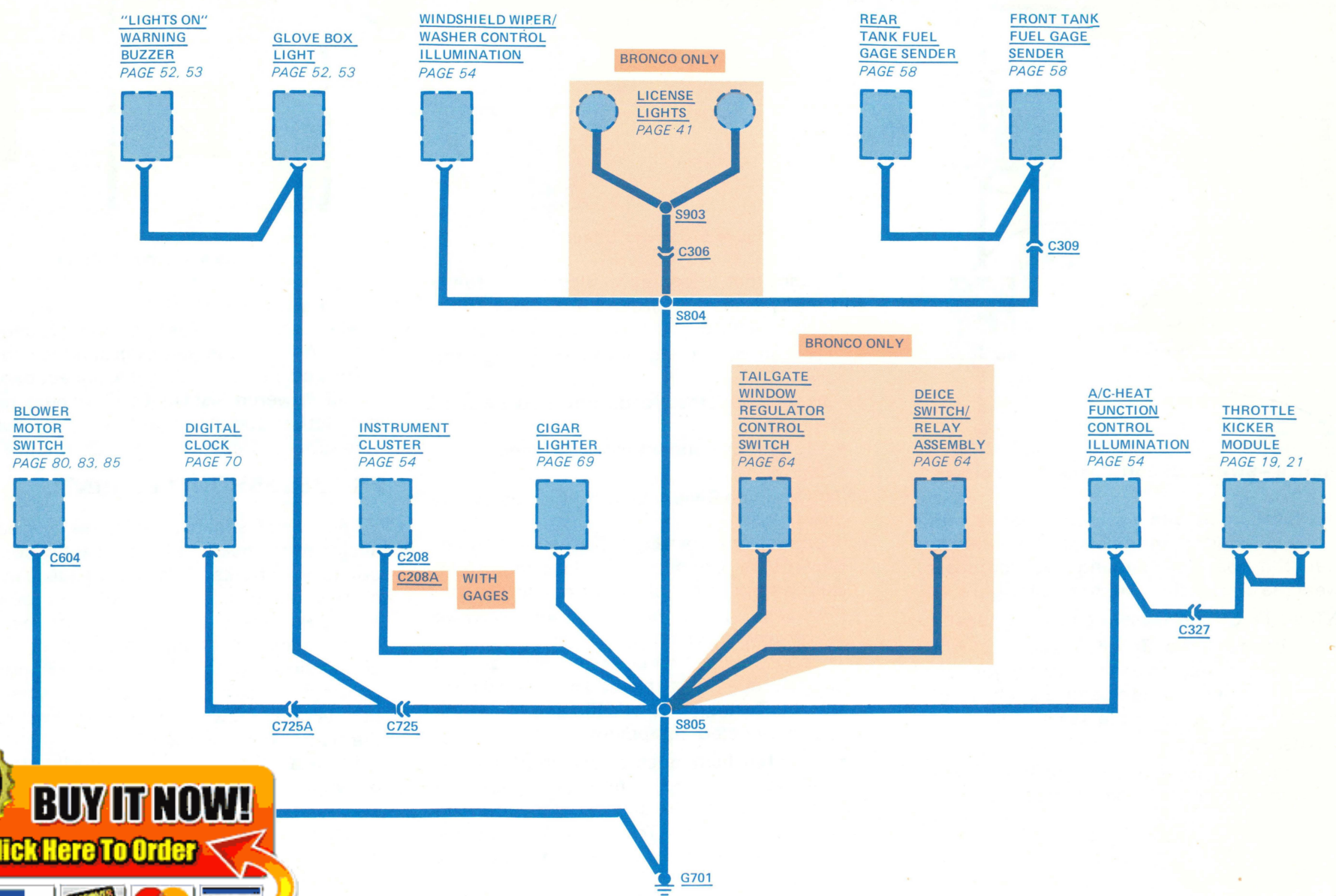

100% SATISFACTION GUARANTEED

BUY IT NOW!

Click Here To Order

FRONT LIGHTS GROUNDS

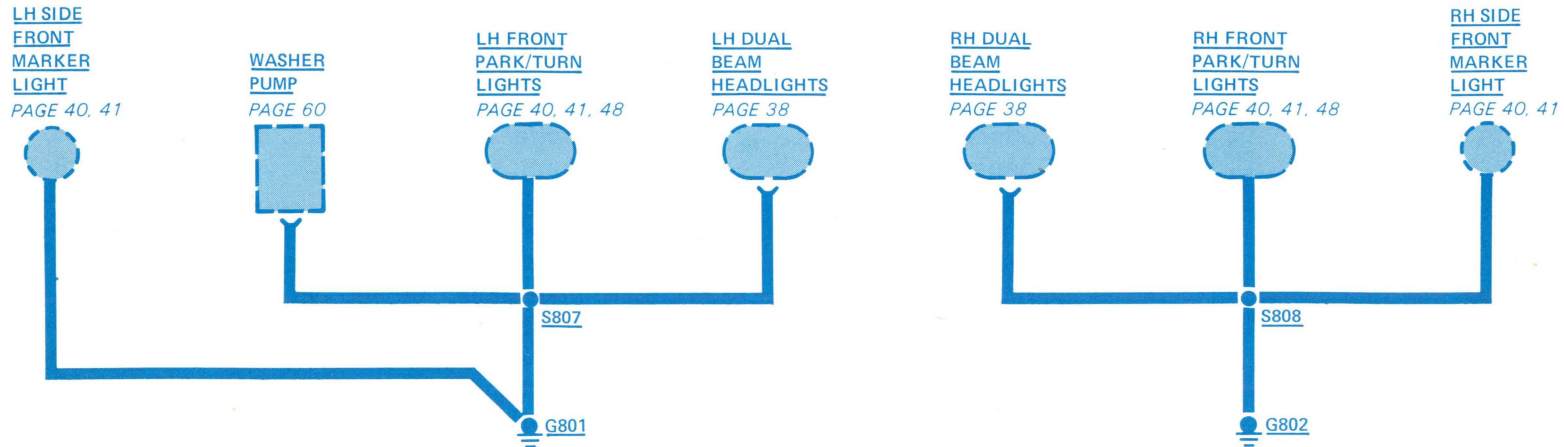

BRONCO REAR LIGHTS GROUNDS



F100-F350 REAR LIGHTS GROUNDS

WITHOUT REAR BUMPER

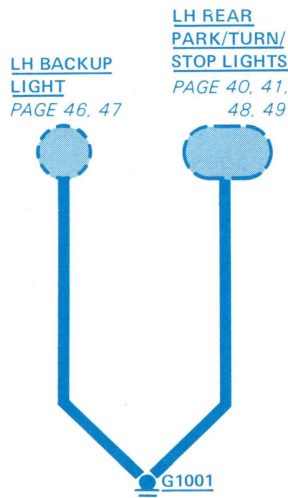

WITH REAR BUMPER

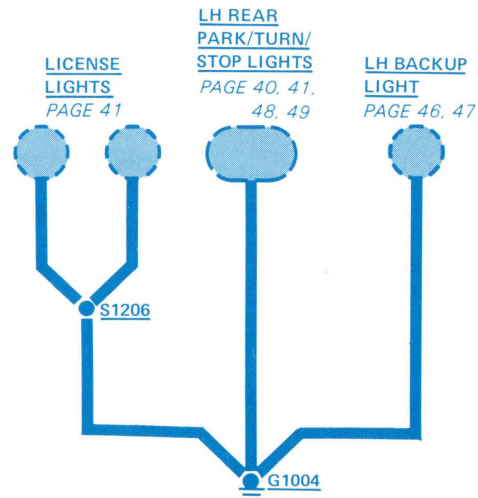

WITH OR WITHOUT REAR BUMPER

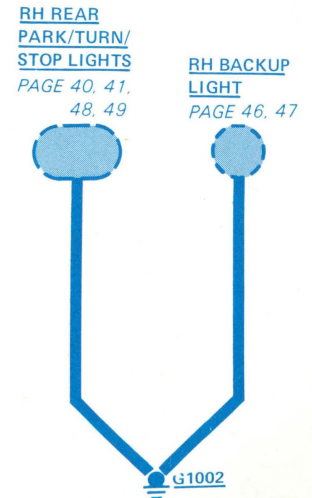

100% SATISFACTION GUARANTEED

BUY IT NOW!

Click Here To Order

PayPal, American Express, Discover, MasterCard, VISA

ENGINE GROUND 6 CYL WITH MCU

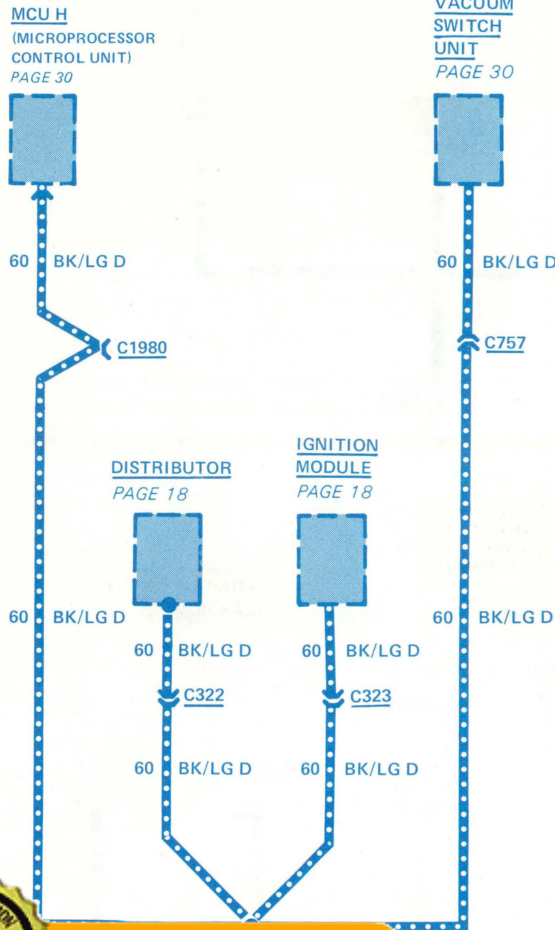

COMPONENT LOCATION

		Page-Figure	Color	Terminals
Connector C208	Attached to instrument cluster	55-1	GY	14
Connector C208A	Attached to instrument cluster	55-1	GY	18
Connector C306	At LH side of dash panel	44-1	GY	11
Connector C322	At distributor	28-1	BK	3
Connector C323	At ignition module	9-3	BK	4
Connector C327	Behind center of I/P	55-1	GY	3
Connector C604	At blower resistors	83-1		
Connector C725	Behind center of I/P	55-1	GY	4
Connector C725A	Behind center of I/P	55-1	GY	4
Connector C757	Near vacuum switch unit	28-1		
Connector C1980	Near ignition module	9-3		
Ground G701	Behind I/P near RH side of radio	55-1		
Ground G754	LH side of engine near oil filter	28-1		
Ground G801	On LH inner fender behind headlights	38-2		
Ground G802	On RH inner fender behind headlights	38-1		
Ground G804	On frame forward of LH rear light assembly	47-2		
Ground G805	On frame forward of RH rear light assembly	47-1		
Ground G1001	On frame forward of LH rear light assembly	47-2		
Ground G1002	On frame forward of RH rear light assembly	47-1		
Ground G1004	On frame forward of LH rear light assembly	45-1		

The ground circuits shown here are complete, and connect several components together to screw terminal ground points. On other pages only parts of these circuits may be shown. Partial ground circuits are shown dashed on those pages.

All simple or component ground circuits are shown on the individual circuit pages, and are complete on those pages.

All wires are 57 BK unless otherwise noted.

100% SATISFACTION GUARANTEED

BUY IT NOW!

Click Here To Order

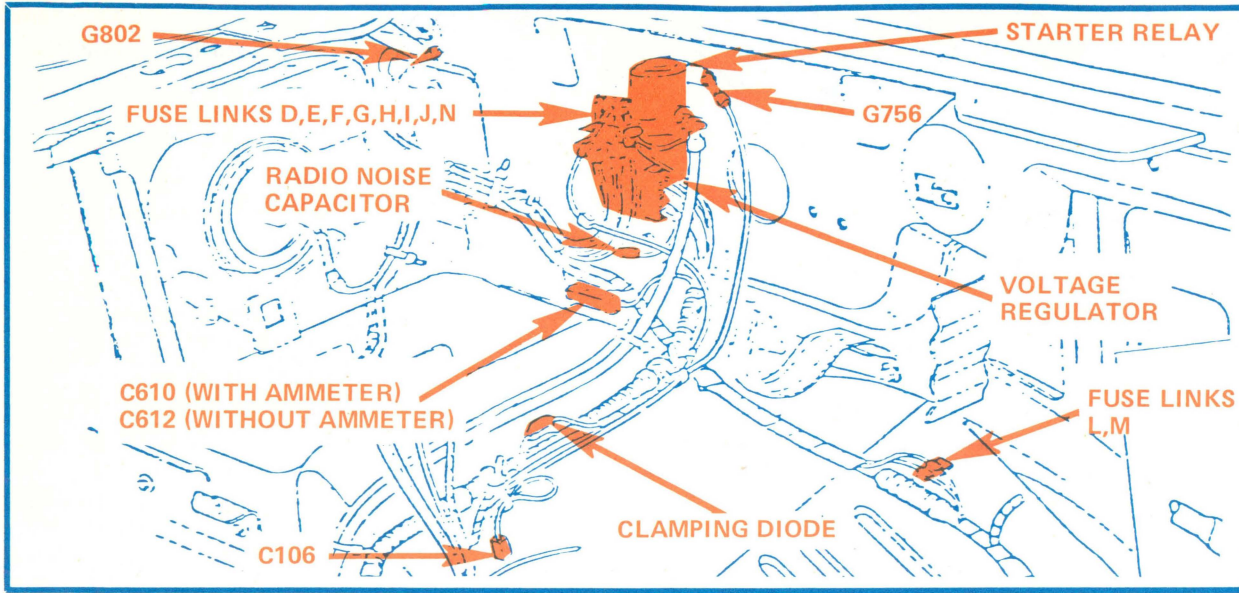

Figure 1 - RH Front Fender Apron

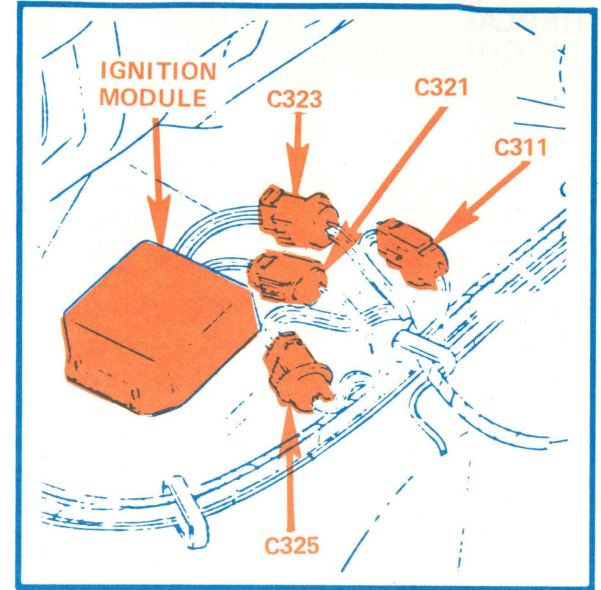

Figure 2 - At LH Inner Fender Well

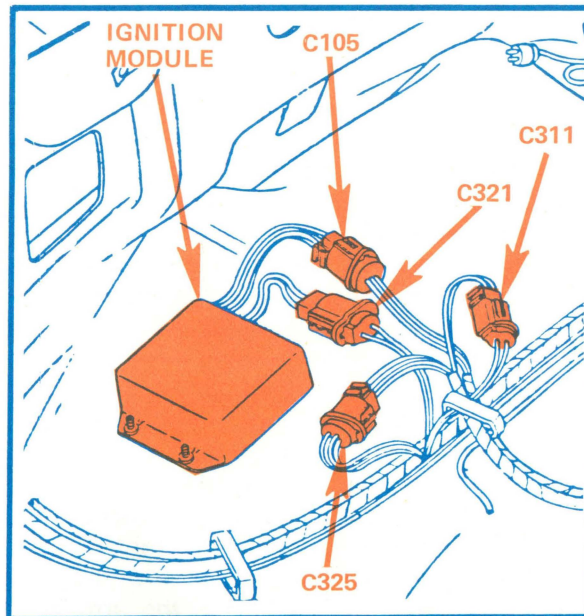

Figure 4 - LH Inner Fender Well (With EEC)

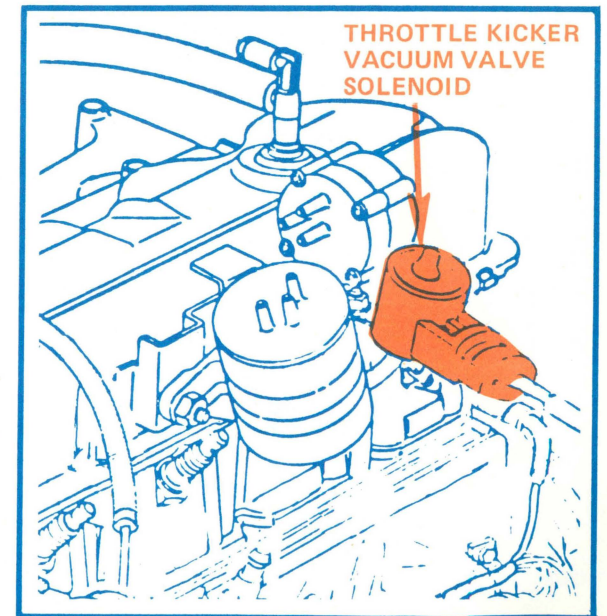
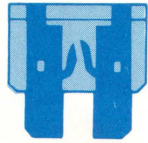

Figure 5 - LH Rear Of 4.9 L Engine

REPLACEMENT OF FUSES/ CIRCUIT BREAKERS



GOOD FUSE



BLOWN FUSE

Fuses are mounted either in the **Fuse Block** or in-line. They are identified by the numbered value in amperes, and by a color code. Some positions may have either a fuse with adapter or a circuit breaker. Be sure to replace a fuse or circuit breaker with the same kind of unit and with the same ampere rating. Remove fuses in order to check them.

CIRCUIT BREAKER OPERATION

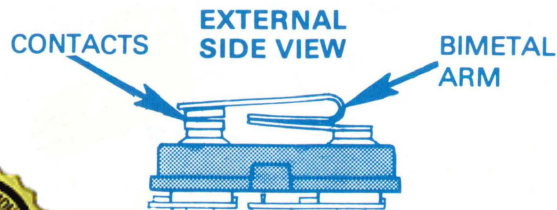
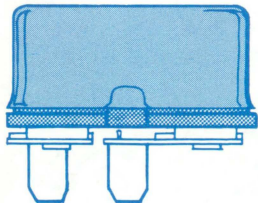

Some circuits are protected by circuit breakers. (Abbreviated "c.b." in fuse chart.) They can be **Fuse Block** mounted or in-line. Like fuses, they are rated in amperes.

Each circuit breaker conducts current through an arm made of two types of metal fastened together (bimetal arm). If the arm starts to carry too much current, it heats up. As one metal expands faster than the other the arm bends, opening the contacts. Current flow is broken. In the cycling type, the arm cools and straightens out. This closes the circuit again. This cycle repeats as long as the overcurrent exists, with power applied.

In the non-cycling type, there is also a coil wrapped around the bimetal arm. When an overcurrent exists and the contacts open, a small current passes through the coil. This current through the coil is not large enough to operate a load, but it does heat up both the coil and bimetal arm. This keeps the arm in the open position until power is removed.

CONTACTS BIMETAL ARM COIL

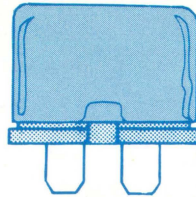

**EXTERNAL
SIDE VIEW**

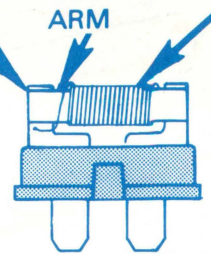

**INTERNAL
SIDE VIEW**

Non-Cycling Fuse Block Type

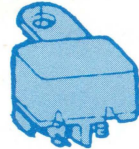

Cycling In-Line Type

FUSE LINKS

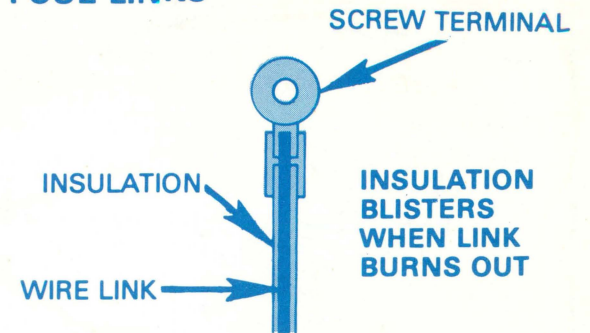

The fuse link is a short length of wire smaller in gage than the wire in the protected circuit. The wire is covered with a thick non-flammable insulation. An overload causes the link to heat and the insulation to blister. If the overload remains, the link will melt, causing an open circuit. The links are color coded for wire size as follows:

COLOR CODE

BLUE	20 GA
RED	18 GA
ORANGE	16 GA
GREEN	14 GA

When replacing, make tight crimp joints or hot solder joints for good connections.

DIODES



Diodes are electrical devices that permit current to flow in one direction only. The current flows in the direction indicated by the arrow.

100% SATISFACTION GUARANTEED

BUY IT NOW!

Click Here To Order

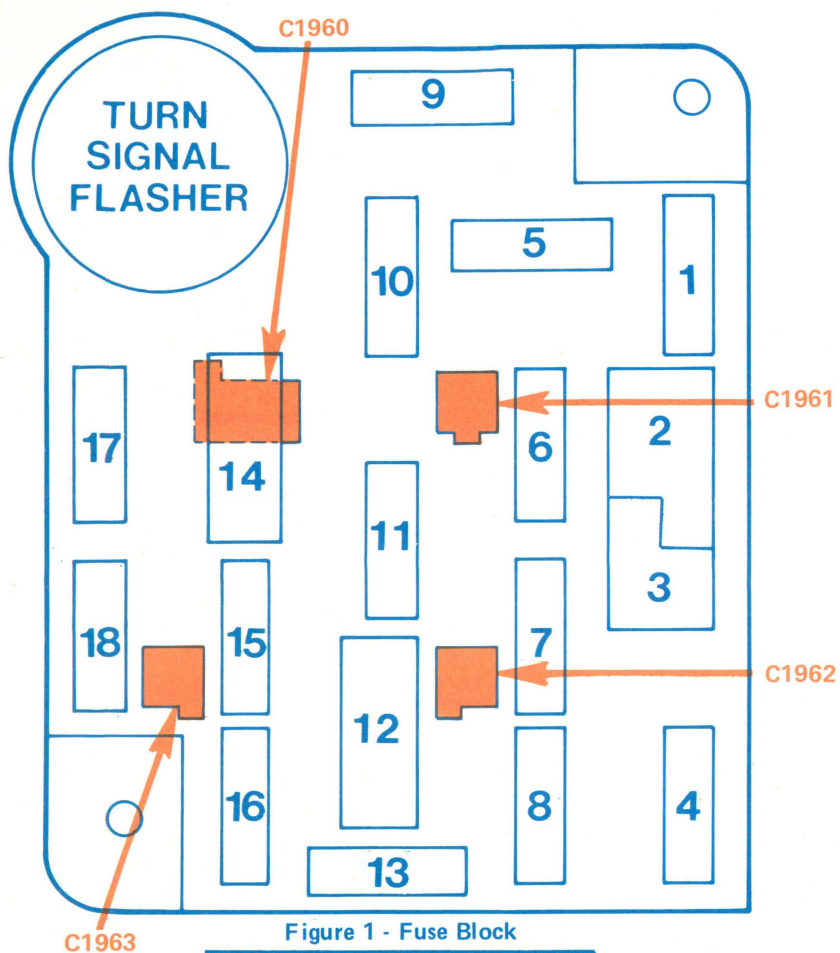

Fuse Position	Amps	Circuits Protected
1	20	Stop/Hazard Lights; Speed Control
2	--	(Not used)
3	--	(Not used)
4	15	Exterior Lights; Instrument Illumination
5	15	Turn Lights; Backup Lights
6	15	Speed Control; 4-Wheel Drive Indicator; Auxiliary Battery Control; Digital Clock; Auxiliary Heater
7	--	(Not used)
8	15	Courtesy, Dome, Cargo Lights; CB Radio Memory
9	30	Heater; A/C-Heat
10	--	(Not used)
11	15	Radio; CB Radio
12	25	Tailgate Power Window
13	30 c.b.	Power Door Locks
14	--	(Not used)
15	25	Tailgate Power Window
16	20 c.b.	Power Windows
17	10	Auxiliary Fuel Tank Selector
18	20	Horn; Cigar Lighter
	5	Instrument Illumination
	15	Seatbelt Buzzer; Warning Indicators; Carburetor Circuits; Feedback Carburetor Control; Tachometer; Choke Heater

Fuse Value Amps	Color Code
4	Pink

100% SATISFACTION GUARANTEED

BUY IT NOW!

Click Here To Order

PayPal Discover Cards American Express MasterCard VISA

Power Distribution

The **Alternator** and **Battery** are connected together at the **Starter Relay** hot terminal. Other circuits originate at the **Starter Relay** hot terminal and are protected by fuse links. Low power circuits are also protected by fuses.

The **Ignition Switch** and **Light Switch** are powered at all times as are **Fuses 1, 4, 8, 10, and 16**. The other fuses are powered through the **Ignition Switch** or the **Light Switch**.

12 CHARGE/POWER DISTRIBUTION (WITH ALTERNATOR WARNING INDICATOR)

**BRONCO
F100-F350**

WITH ALTERNATOR WARNING INDICATOR

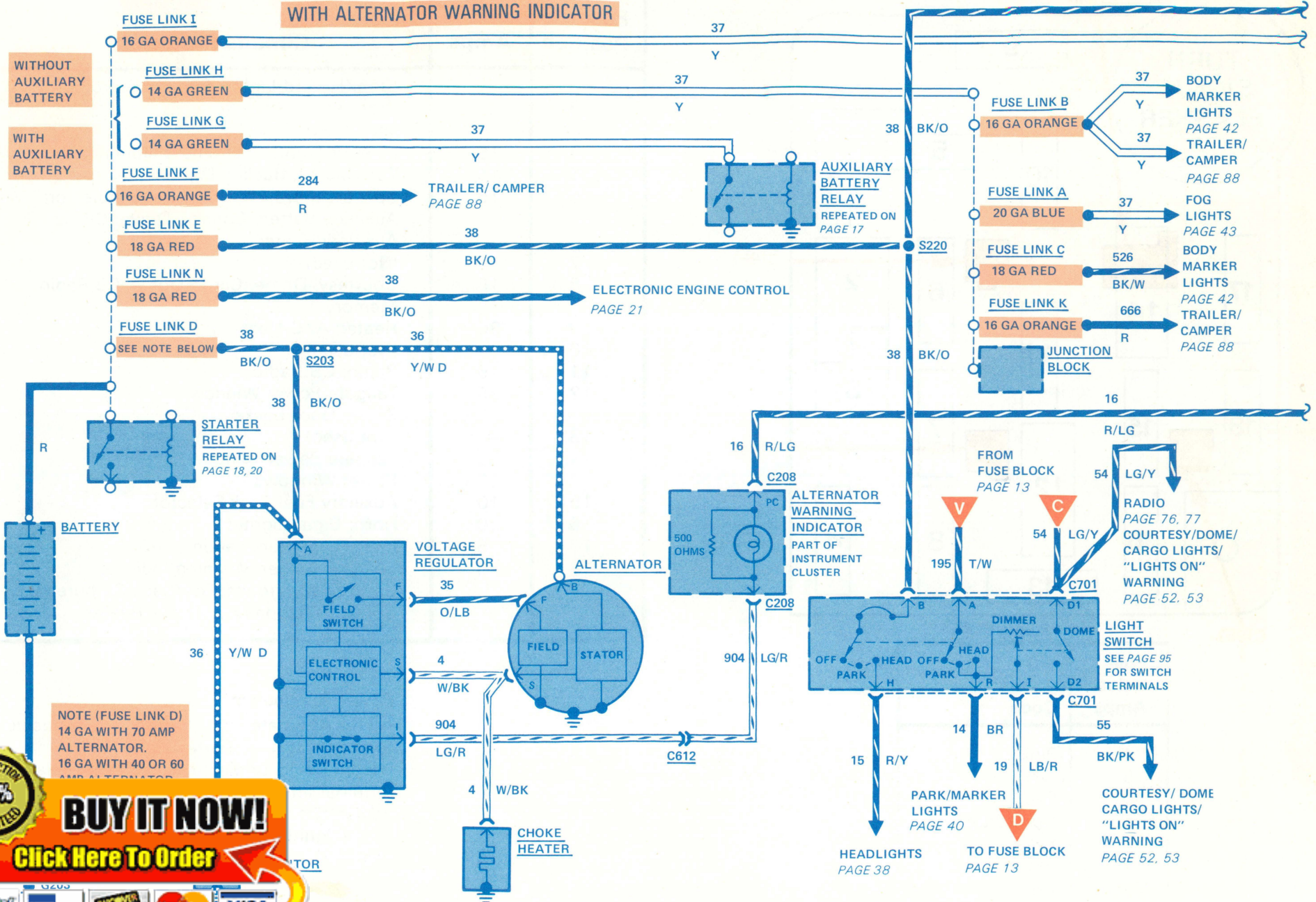

100% SATISFACTION GUARANTEED

BUY IT NOW!

Click Here To Order

PayPal, Discover, MasterCard, VISA

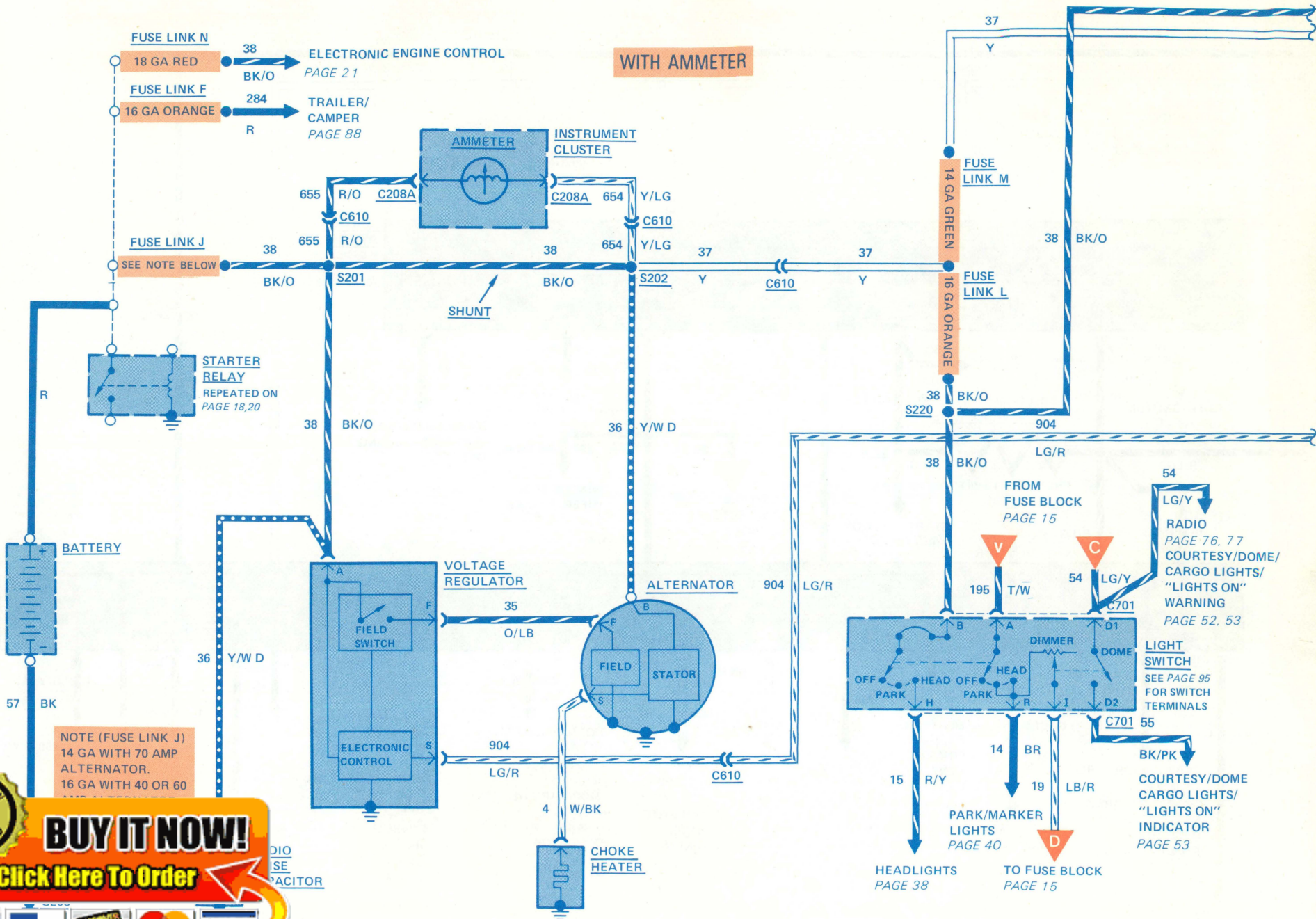

100% GUARANTEED

BUY IT NOW!

Click Here To Order

PayPal, American Express, Discover, MasterCard, VISA

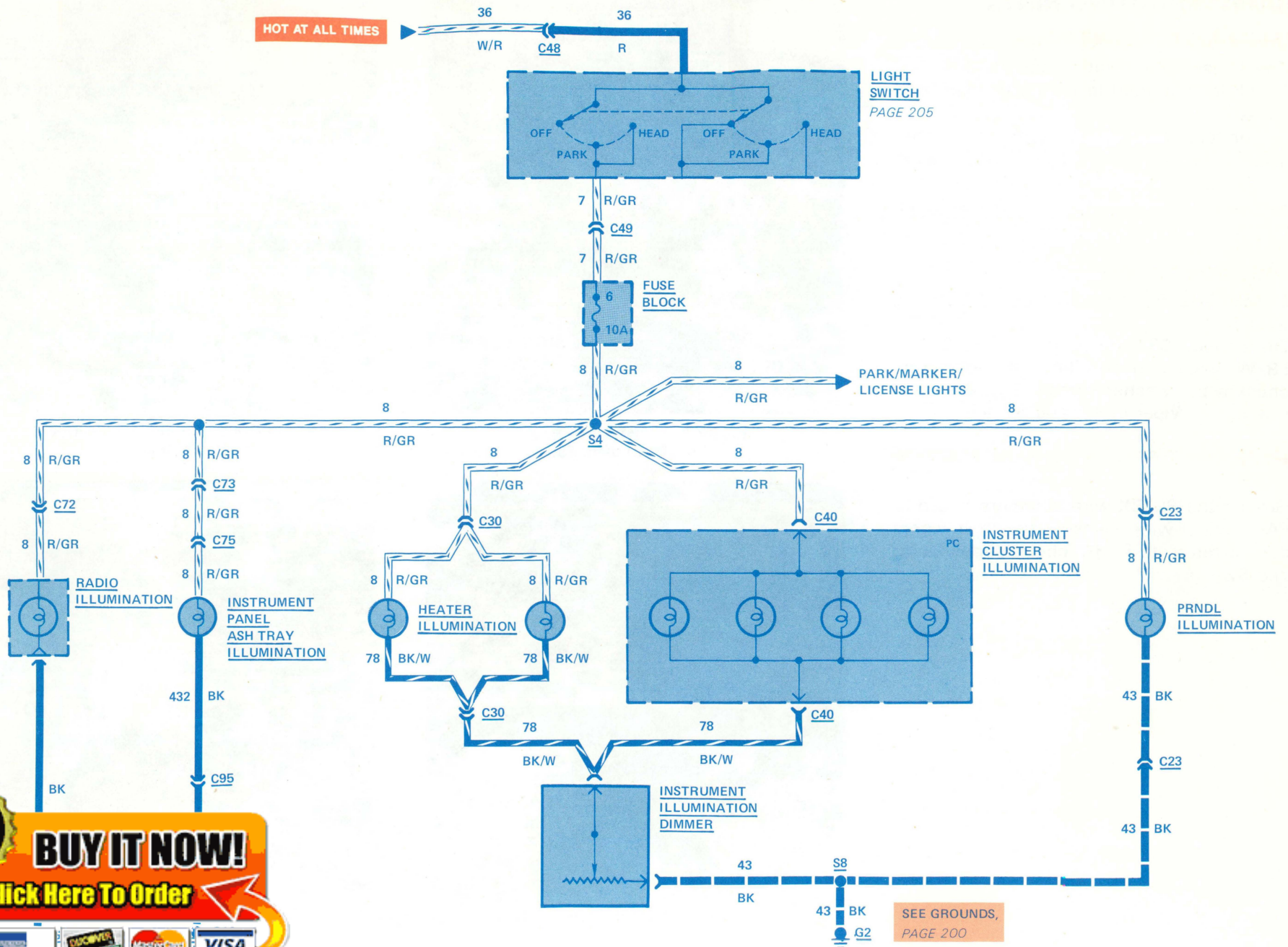

100% SATISFACTION GUARANTEED

BUY IT NOW!

Click Here To Order

TROUBLESHOOTING HINTS

NO INSTRUMENT ILLUMINATION WORKS

- Check **Fuse 6** by operating **Park Lights**.
- Check **Light Switch** if **Park Lights** also don't work but **Fuse 6** is OK.

DIMMER DOESN'T WORK

- Remove connectors from **Instrument Illumination Dimmer** and check resistance of dimmer.
- Check in-line connectors.

ONE LIGHT NOT WORKING

- Check bulb and socket.
- Check continuity to ground.

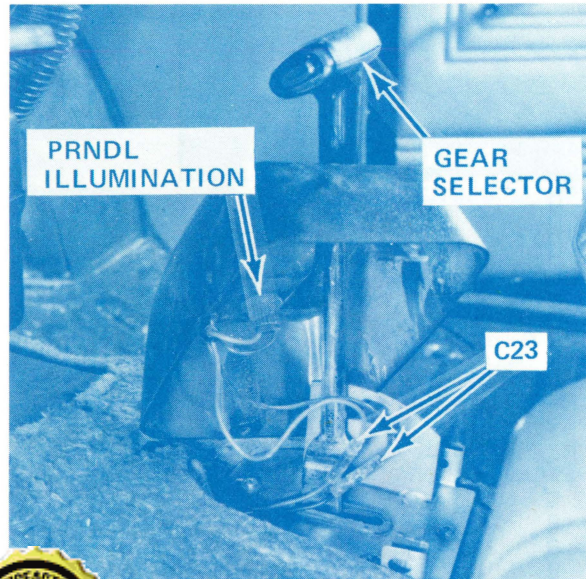

COMPONENT LOCATION

		Page-Figure	Color	Terminals
Light Switch.....	Top LH side of steering column.....			
Connector C23.....	Under shifter lever trim cover.....	229-1	clear	1
Connector C30.....	Behind RH side of instrument cluster below heater controls.....	229-2	W	2
Connector C40.....	Attached behind instrument cluster.....	229-2	W	12
Connector C48.....	Under LH side of instrument panel near steering column.....	227-3	W/BLK	1
Connector C49.....	Under LH side of instrument panel near steering column.....	227-3	W/BLK	6
Connector C72.....	Behind center of instrument panel attached to radio assembly.....	229-2	BLK	2
Connector C73.....	Behind LH side of instrument panel taped to harness if not used.....	229-2	W	3
Connector C95.....	Behind center of instrument panel above ash tray assembly.....	229-2	BLK	3
Ground G2.....	Under LH side of instrument panel at turn signal mounting bracket.....	227-1		
Ground G10.....	Behind center of instrument panel			
Ground G13.....	At antenna mounting on fender			

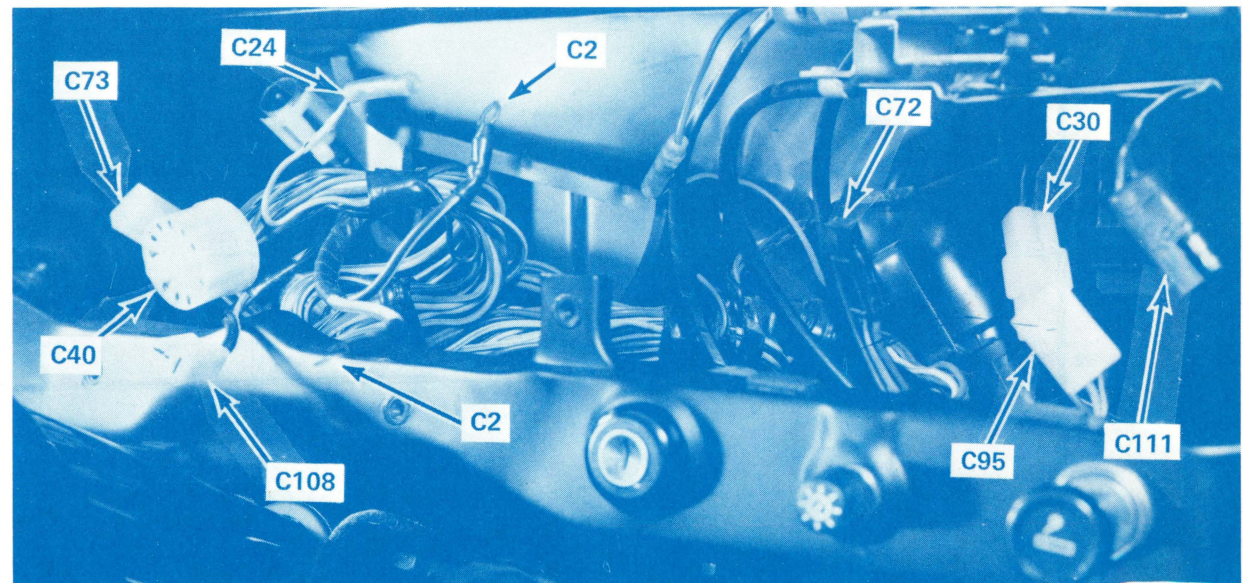
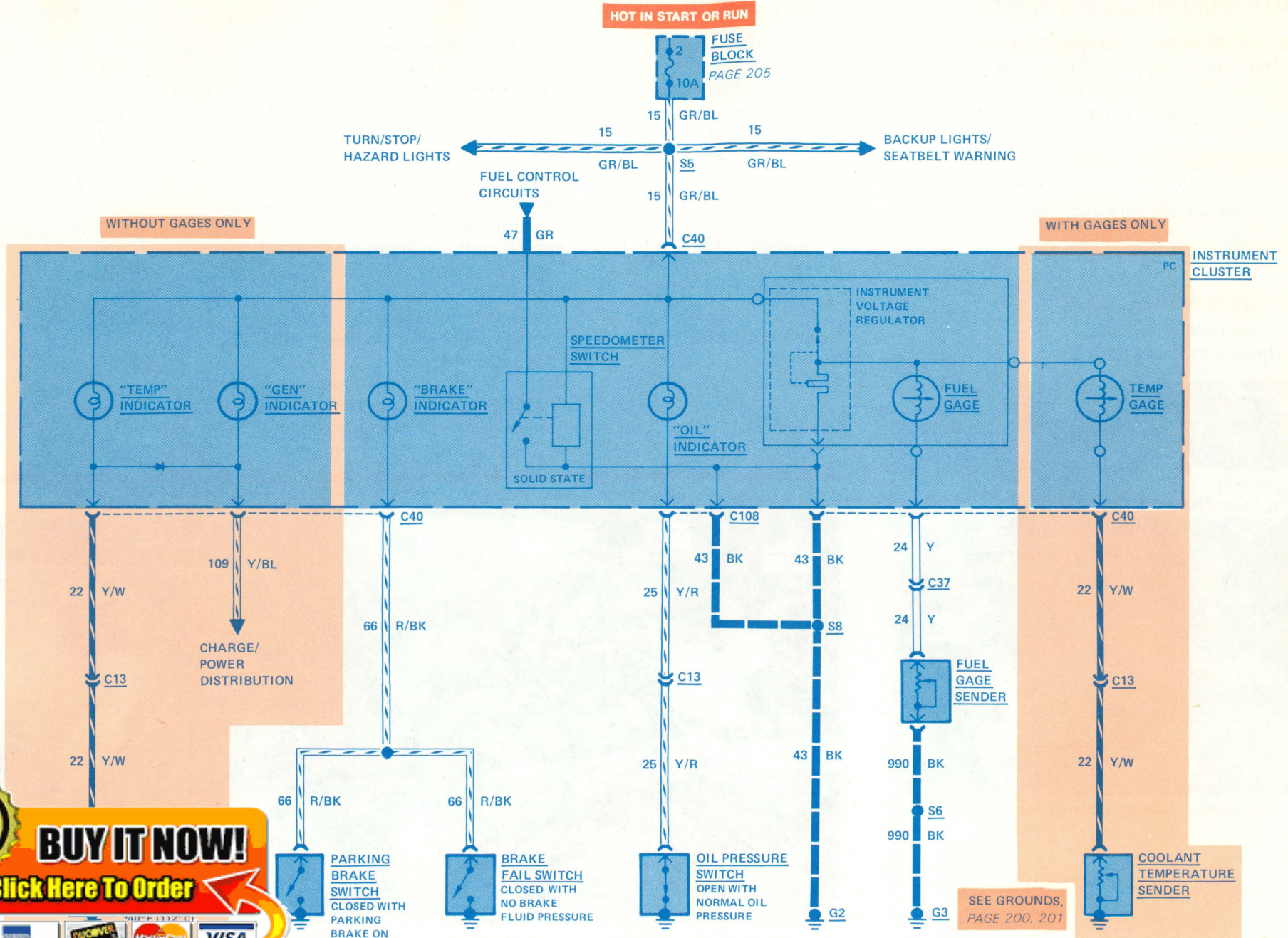

Figure 2 - Behind Instrument Cluster

100% SATISFACTION GUARANTEED

BUY IT NOW!

Click Here To Order



100% SATISFACTION GUARANTEED

BUY IT NOW!

Click Here To Order

PayPal

Discover Cards

AMERICAN EXPRESS

MasterCard

VISA

HOW THE CIRCUIT WORKS

With the **Ignition Switch** in START or RUN, current can flow through **Fuse 2** to the **Brake Indicator** and **Oil Indicator**.

The **Oil Indicator** goes on with the **Oil Pressure Switch** closed (low oil pressure).

The **Brake Indicator** will go on: 1) with the **Brake Fail Switch** closed (no brake fluid pressure); 2) with the **Parking Brake Switch** closed.

For the circuit operation of the **Speedometer Switch**, refer to the **Fuel Control** circuit.

In START or RUN, current can also flow through the instrument voltage regulator to the **Fuel Gage**. The instrument voltage regulator supplies a pulsating output voltage (5.0 volts average) to power the gage. The **Fuel Gage** is connected to the **Fuel Gage Sender**. The sender is a variable resistor connected to a float in the fuel tank. When the fuel is low, resistance is high; when fuel is high, resistance is low.

With Gages

The **Temp Gage** is powered by the instrument voltage regulator and is connected to the **Coolant Temperature Sender**. When temperature is low, resistance is high. When temperature is high, resistance is low.

Without Gages

With the **Ignition Switch** in RUN, the **Temp Indicator** goes on if the **Coolant Temperature Switch** closes, showing high coolant temperature.

the **Ignition Switch** in START or RUN, the **Brake Indicator** is

COMPONENT LOCATION

Brake Fail Switch	Top RH side of engine cowl		
Coolant Temperature Sender/Switch (2.0 liter) (2.3 liter)	Top LH front side of cylinder head		
Fuel Gage Sender	LH rear of engine below oil pressure switch .	217-2	
Instrument Cluster	Top center of fuel tank		
Oil Pressure Switch (2.0 liter) (2.3 liter)	LH side of instrument panel	227-3	
Parking Brake Switch	Lower RH side of engine at oil filter extension	217-6	
Connector C5 (2.0 liter only)	Upper LH rear side of cylinder head.....	217-2	
Connector C13 (2.3 liter) .	Top of parking brake support.....	211-4	
Connector C37	LH fender apron below fuse block	213-2	W 6
Connector C40	LH fender apron near fuse block	233-1	W 8
Ground G2	LH fender apron near fuse block	233-1	W 6
	Attached behind instrument cluster	229-2	W 12
Ground G3 (2.0 liter)	Under LH side of instrument panel at turn signal mounting bracket.....	227-1	
(2.3 liter)	Center of LH fender apron below fuse block	213-2	
	LH fender apron at lower ignition coil mounting bracket	202-3	

TROUBLESHOOTING HINTS

ANY WARNING INDICATOR DOESN'T GO ON

- Check bulb. Check continuity from PC to ground.
- Check for voltage at **GR/BL** wire of PC.
- Remove and check PC.

FUEL GAGE ERRATIC, HIGH, OR LOW

- Check voltage regulator ground.
- Bench test voltage regulator.

FUEL GAGE DOESN'T WORK

- Disconnect **Y** wire at sender. Connect one lead of voltmeter or test light to **Y** wire. Connect other meter (light) lead to ground. A pulsating light or varying voltage should appear.

- If light stays on, or voltage reading is steady, replace voltage regulator. If no voltage appears, check for open circuit in gage or wiring.
- Perform Gage "Calibration Test" in Shop Manual.
- Check that resistance of sender is 10 to 73 ohms.

FUEL GAGE OUT OF CALIBRATION

- Perform "Fuel Gage and Instrument Voltage Regulator Calibration Test" in Shop Manual.

RADIO

HOW THE CIRCUIT WORKS

With the **Ignition Switch** in ACCY or RUN, current can flow through **Fuse 4** to operate the **Radio**.

TROUBLESHOOTING HINTS

Radio

RADIO DOESN'T WORK

- Check **Fuse 4** by operating heater.
- Check **Antenna** ground (G13).

SPEAKER DOESN'T WORK

- Check for resistance of 2 to 4 ohms across **Speaker**. **Speaker** will click when voltage is applied.

NOISY RECEPTION

- Check **Suppression Capacitor**.
- Check antenna connections.

COMPONENT LOCATION

		Page-Figure	Color	Terminals
Glove Box Light and Switch	Inside of glove box			
Rear Window Deice.....	Part of rear window			
Rear Window Deice Relay .	LH side of instrument panel			
Rear Window Deice Switch	Front RH side of hood			
Under Hood Light Switch .	Behind center of instrument panel attached			
Connector C72	to radio assembly	229-2	BLK	2
Connector C73	Behind LH side of instrument panel, taped to harness if not used	229-2	W	3
Connector C81	Attached to deice relay		—	4
Connector C96	LH side of dash panel under rear corner of hood	233-1	clear	1
Connector C111	Attached to speaker		—	2
Connector C112	Behind LH kick-panel		—	2
Ground G10.....	Behind center of instrument panel			
Ground G12.....	On frame near rear window			
Ground G13.....	At antenna mounting on fender			

TROUBLESHOOTING HINTS

WEAK OR NO SIGNAL

- Check antenna lead wire continuity and isolation from ground.

DEICE DOESN'T WORK

- Check for click at relay when switch is turned ON and OFF.
- Check for voltage at Y/W wire of **C81**.
- Check that **G12** is clean and tight.

UNDER HOOD/ GLOVE BOX LIGHTS

HOW THE CIRCUIT WORKS

Voltage is applied at all times through the **Glove Box Light** to its switch and also through

the **Under Hood Light** to its switch. When either switch is closed, its bulb goes on.

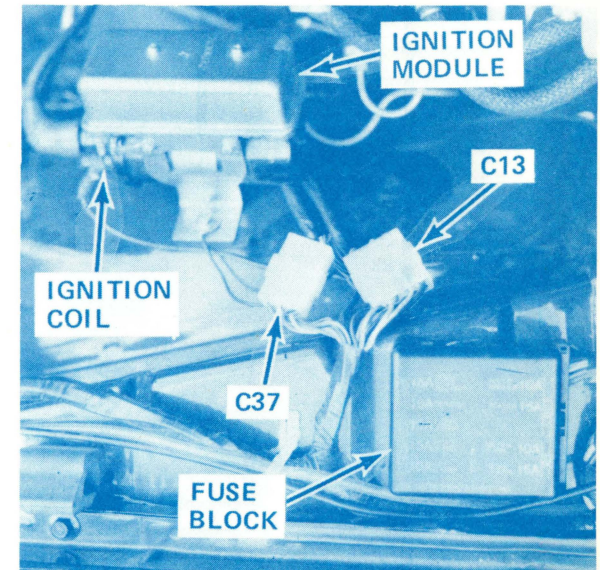

Figure 1 - Rear Of LH Fender Apron (2.3 Liter)

100% SATISFACTION GUARANTEED

BUY IT NOW!

Click Here To Order

PayPal, American Express, Discover, MasterCard, VISA

HEATER

HOW THE CIRCUIT WORKS

With the Ignition Switch in ACCY or RUN, current flows through Fuse 4 and the Heater Blower Switch to operate the Heater Blower Motor.

The blower switch controls the speed of the motor. In HI, power flows directly to the motor; in MED, through one blower resistor; in LO, both resistors.

TROUBLESHOOTING HINTS

BLOWER DOESN'T WORK

- Check Fuse 4.
- Separate C15. Set blower switch to OFF. Check for continuity to ground (less than 3 ohms) at all terminals of connector. If bad, check continuity of Heater Blower Motor and Heater Blower Resistors.
- Check connectors for corrosion (voltage drop).
- Check that G8 is clean and tight.
- Check continuity of switch and connectors.
- Check resistance of resistors.

A/C-HEAT

HOW THE CIRCUIT WORKS

With the Ignition Switch in ACCY or RUN, current flows through Fuse 4 and the A/C Blower Switch to operate the A/C Blower Motor and Fuel Control System. The A/C Blower Switch controls the speed of the blower motor. In HI, power flows directly to the motor; in MED, through one blower resistor; in LO, both resistors.

COMPONENT LOCATION

		Page-Figure	Color	Terminals
A/C Blower Motor	RH side of blower assembly			
A/C Blower Resistors	RH side of blower assembly			
A/C Clutch Solenoid	Part of A/C compressor assembly			
A/C Control Switch	Center of blower assembly			
A/C Temperature Control Switch	Center of blower assembly			
Heater Blower Motor	Under center of I/P	217-4		
Heater Blower Resistors	Under center of I/P, to left of blower motor	217-4		
Heater Blower Switch	Part of heating and ventilation controls			
Connector C15	Below center of I/P, near heater blower motor	217-4	BLK	3
Connector C16	Near heater blower motor	217-4	clear	1
Connector C104	Behind center of I/P, near blower motor		BLK	3
Connector C113	Under center of I/P	211-2	RED	1
Connector C114	Under center of I/P	211-2	—	2
Connector C115	LH side of engine cowl near three-way solenoid valve		—	2
Ground G8	Under center of I/P, to left of blower motor	217-4		
Ground G14	RH rear I/P mounting bracket	211-3		

The A/C Control Switch also controls the operation of the A/C Clutch Solenoid and the Fuel Control circuits. The A/C Temperature Control Switch closes with warm air flowing through the A/C system to supply power to the A/C Clutch Solenoid and the Fuel Control circuits. The Fuel Control System increases engine idle speed when the air conditioning is operated. Refer to Fuel Control circuit for details.

TROUBLESHOOTING HINTS

COMPRESSOR CLUTCH DOES NOT WORK

- Check Fuse 4 by operating Heater Blower Motor. Make sure ground point at A/C Clutch Solenoid is clean and tight.
- Separate C115. Check for continuity to ground across clutch solenoid field.
- Separate connector at A/C Temperature Control Switch. With temperature control in

coldest position and warm air blowing through the system, check continuity across switch.

- Check circuit continuities. Check all connectors for corrosion.

NO COOLING OR NOT ENOUGH COOLING

- Check for current at A/C Clutch Solenoid.
- Check continuity of the A/C Temperature Control Switch and A/C Control Switch.
- Check A/C Compressor drive belt tension.
- Check refrigerant pressures.

BLOWER DOESN'T WORK

- Check Fuse 4 by operating Heater Blower Motor.
- Check that G14 is clean and tight.
- Separate C114. Set control to OFF. Check for continuity to ground (less than 3 ohms) at all terminals of connector. If bad, check continuity of A/C Blower Motor and A/C Blower Resistors.

100% SATISFACTION GUARANTEED

BUY IT NOW!

Click Here To Order

PayPal American Express Discover MasterCard VISA



**WE SUPPORT VOLUNTARY
MECHANIC CERTIFICATION**



100% SATISFACTION GUARANTEED

BUY IT NOW!

Click Here To Order 



**Ford Parts and Service Division
Training and Publications Department**

U.S.A.

0331-521