

**Free Bonus!**  
 30-Minute Video  
 Ford Training  
 Course 13001, Vol 68 S7  
 "How to Read Wiring  
 Diagrams"  
 Included!

# Colorized

# Mustang Wiring Diagrams

*(with Electrical Illustrations)*

A consolidated collection of original Ford wiring diagrams and electrical illustrations

## Diagrams for:

- Accessories
  - Convertible Top
  - Exterior Lighting, Turn Signals, and Horns
  - Ignition, Starting and Charging
  - Interior Lighting, Windshield Wipers and Gauges
  - Instrument Panel w/ Alternator
  - Instrument Panel w/ Generator
  - Power Top
- ...and much more!!

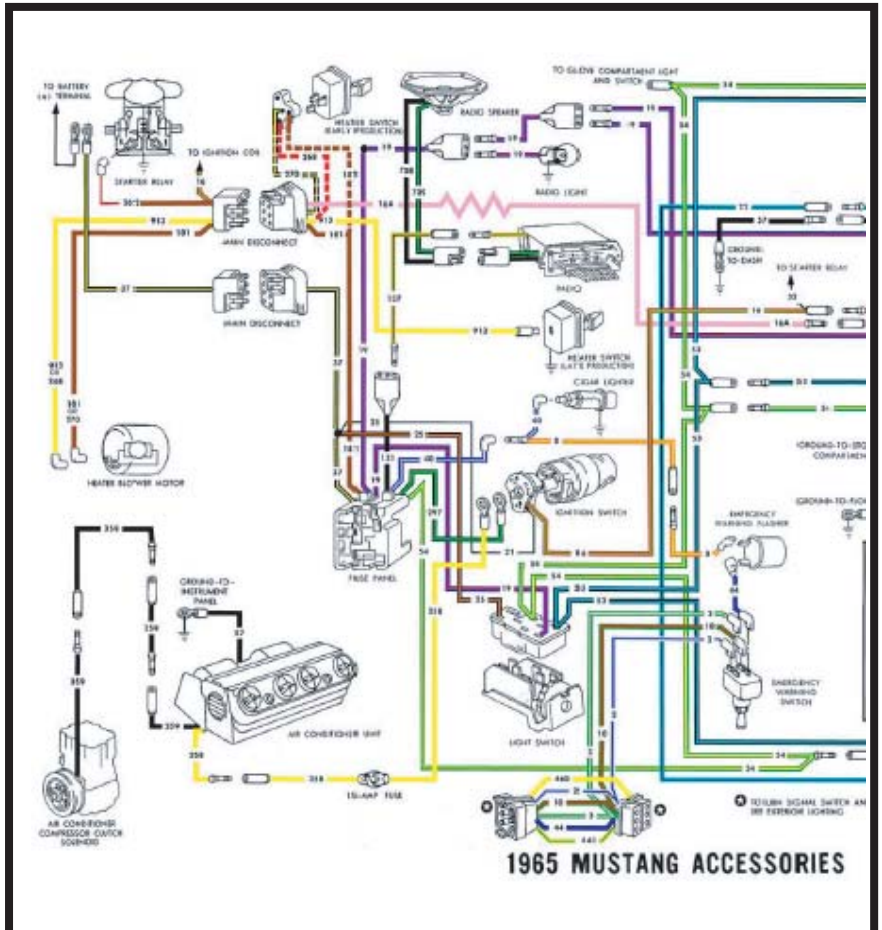

Example of colorized diagrams

Licensed and approved by the Ford Motor Company

**100% SATISFACTION GUARANTEED**

**BUY IT NOW!**

**Click Here To Order**

Copyright © 2008, Forel Publishing Company, LLC, Woodbridge, Virginia

All Rights Reserved. No part of this book may be used or reproduced in any manner whatsoever without written permission of Forel Publishing Company, LLC. For information write to Forel Publishing Company, LLC, 3999 Peregrine Ridge Ct., Woodbridge, VA 22192

1965 Colorized Mustang Wiring Diagrams  
(Extracted from Form FD-7795P-65, FP-7635B, and FD-7943-G)  
EAN: 978-1-60371-024-4  
ISBN: 1-60371-024-8

***Forel Publishing Company, LLC***  
***3999 Peregrine Ridge Ct.***  
***Woodbridge, VA 22192***  
***Email address: [webmaster@ForelPublishing.com](mailto:webmaster@ForelPublishing.com)***  
***Website: <http://www.ForelPublishing.com>***



This publication contains material that is reproduced and distributed under a license from Ford Motor Company. No further reproduction or distribution of the Ford Motor Company material is allowed without the express written permission of Ford Motor Company.

---

## Disclaimer

Although every effort was made to ensure the accuracy of this book, no representations or warranties of any kind are made concerning the accuracy, completeness or suitability of the information, either expressed or implied. As a result, the information contained within this book should be used as general information only. The author and Forel Publishing Company, LLC shall have neither liability nor responsibility to any person or entity with respect to any loss or damage caused, or alleged to be caused, directly or indirectly by the information contained in this book. Further, the publisher and author are not engaged in rendering legal or other professional services. If legal, mechanical, electrical, or other expert assistance is required, the services of a competent professional should be sought.

---





## ATTENTION



### Please Read This

The color coded wiring diagrams are provided for illustration purposes only. Only the wire number should be used for the identification of the wire itself. The color coding of the wires in the product may not match the actual colors of the wires in the vehicle. In some cases, the colors have been altered to provide a visual contrast (i.e. the color white has been shaded to make it more visible).

**Disclaimer:** Although every effort was made to ensure the accuracy of this book, no representations or warranties of any kind are made concerning the accuracy, completeness or suitability of the information, either expressed or implied. As a result, the information contained within this book should be used as general information only. The author and Forel Publishing Company, LLC shall have neither liability nor responsibility to any person or entity with respect to any loss or damage caused, or alleged to be caused, directly or indirectly by the information contained in this book. Further, the publisher and author are not engaged in rendering legal or other professional services. If legal, mechanical, electrical, or other expert assistance is required, the services of a competent professional should be sought.

**100% SATISFACTION GUARANTEED**

**BUY IT NOW!**

**Click Here To Order**

PayPal American Express Cards DISCOVER NOVUS MasterCard VISA

## Color Wiring Codes (1965 Ford Mustang)

Number	Wire Description	Source
2	WHITE-BLUE STRIPE	Form 7760-65
3	GREEN-WHITE STRIPE	Form 7760-65
4	WHITE-BLACK STRIPE	Form 7760-65
5	ORANGE-BLUE STRIPE	Form 7760-65
8	ORANGE-YELLOW STRIPE	Form 7760-65
9	GREEN-ORANGE STRIPE	Form 7760-65
10	GREEN-RED STRIPE	Form 7760-65
10A	GREEN	Form 7760-65
11	BLACK-YELLOW STRIPE	Form 7760-65
12	GREEN-BLACK STRIPE	Form 7760-65
13	RED-BLACK STRIPE	Form 7760-65
14	BLACK	Form 7760-65
15	RED-YELLOW STRIPE	Form 7760-65
16	RED-GREEN STRIPE	Form 7760-65
16A	PINK	Form 7760-65
19	BLUE-RED STRIPE	Form 7760-65
21	YELLOW	Form 7760-65
22	BLUE-BLACK STRIPE	Form 7760-65
25	BLACK-ORANGE STRIPE	Form 7760-65
26	BLACK-RED STRIPE	Form 7760-65
28	BLACK	Form 7760-65
29	YELLOW-WHITE STRIPE	Form 7760-65
30	BLACK-GREEN STRIPE	Form 7760-65
31	WHITE-RED STRIPE	Form 7760-65
32	RED-BLUE STRIPE	Form 7760-65
34	GREEN-BLACK STRIPE	Form 7760-65
35	WHITE	Form 7760-65
37	BLACK-YELLOW STRIPE	Form 7760-65
39	RED-WHITE STRIPE	Form 7760-65
40	BLUE-WHITE STRIPE	Form 7760-65
42	BLUE	Form 7760-65
44	BLUE	Form 7760-65
49	WHITE-BLUE STRIPE	Form 7760-65
50	GREEN-WHITE STRIPE	Form 7760-65
53	BLACK-BLUE STRIPE	Form 7760-65
54	GREEN-YELLOW STRIPE	Form 7760-65
		Form 7760-65
		Form 7760-65
		Form 7760-65

61	YELLOW	Form 7760-65
63	RED	Form 7760-65
65	GREEN	Form 7760-65
95	WHITE	Form 7760-65
96	ORANGE-BLACK STRIPE	Form 7760-65
122	YELLOW	Form 7760-65
123	RED	Form 7760-65
131	BLACK	Form 7760-65
137	YELLOW-BLACK STRIPE	Form 7760-65
140	BLACK-RED STRIPE	Form 7760-65
152	YELLOW	Form 7760-65
162	BROWN	Form 7760-65
175	BLACK	Form 7760-65
181	BROWN	Form 7760-65
234	BLACK	Form 7760-65
262	BROWN	Form 7760-65
268	RED	Form 7760-65
270	BLACK-YELLOW STRIPE	Form 7760-65
297	BLACK-GREEN STRIPE	Form 7760-65
358	YELLOW	Form 7760-65
359	BLACK	Form 7760-65
460	YELLOW	Form 7760-65
461	YELLOW-GREEN STRIPE	Form 7760-65
654	YELLOW	Form 7760-65
655	RED	Form 7760-65
708	BLACK	Form 7760-65
709	BLACK-GREEN STRIPE	Form 7760-65
763	ORANGE-WHITE STRIPE	Form 7760-65
904	GREEN-RED STRIPE	Form 7760-65
913	YELLOW	Form 7760-65
941	BLACK-WHITE STRIPE	Form 7760-65

Note – there may be a difference between the actual wire colors and those in this manual. In some cases, colors were shaded differently to provide a visual contrast for easier reading.

**SATISFACTION 100% GUARANTEED**

**BUY IT NOW!**

**Click Here To Order**





















PayPal American Express Discover MasterCard VISA













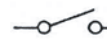

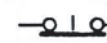
**100% GUARANTEED**  
**BUY IT NOW!**  
 Click Here To Order

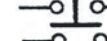
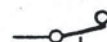
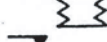
**WIRE SYMBOLS**

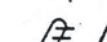







-  HEATER
-  CIRCUIT BREAKER
-  FUSE
-  RESISTOR OR RESISTANCE WIRE
-  DIODE
-  CAPACITOR OR CONDENSER
-  THERMOSTAT (VARIABLE RESISTANCE)
-  THERMISTOR
-  SPARK PLUG
-  GROUND
-  BATTERY
-  MAINTAINED CONTACT
-  MOMENTARY CONTACT
-  SPLICE, WELD OR SOLDER POINT
-  SPLICED WIRES
-  CROSSOVER WIRE (NO CONNECTION)
-  JUNCTION BLOCK
-  HORN
-  BUSS BAR
-  BUS BAR & SPLICE

### SWITCHES



-  N.O. (SPST)
-  N.O. (SPST)
-  N.O. (DPST)
-  PUSH TYPE N.C.
-  PUSH TYPE N.O.
-  PUSH TYPE N.O. MULTIPLE POLE
-  PRESSURE OR VACUUM OPERATED N.C.
-  (SPDT) CENTER OFF
-  ROTARY SWITCH
-  MERCURY SWITCH
-  THERMAL SWITCH INTERNAL HEATER N.C.
-  THERMAL SWITCH INTERNAL HEATER N.C.
-  THERMAL SWITCH EXTERNAL HEATER N.C.

N.O. - NORMALLY OPEN  
 N.C. - NORMALLY CLOSED  
 S.P.S.T. - SINGLE POLE, SINGLE THROW  
 D.P.S.T. - DOUBLE POLE, SINGLE THROW  
 S.P.D.T. - SINGLE POLE, DOUBLE THROW  
 D.P.D.T. - DOUBLE POLE, DOUBLE THROW

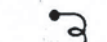

### RELAYS

-  N.O. (SPST)
-  N.C. (SPST)
-  SPDT
-  N.O. DPST
-  N.C. DPST
-  SOLENOID
-  COIL AIR CORE
-  IGNITION COIL

### LAMPS

-  SINGLE FILAMENT
-  DOUBLE FILAMENT

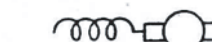
### MOTORS

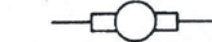
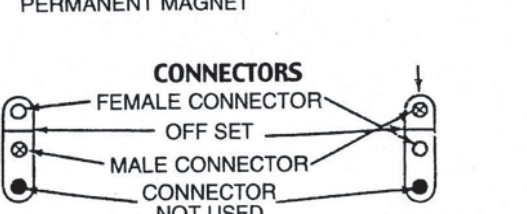





-  BASIC SERIES
-  SPLIT SERIES
-  PERMANENT MAGNET
- 

**CONNECTORS**

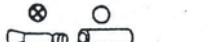
FEMALE CONNECTOR

OFF SET

MALE CONNECTOR

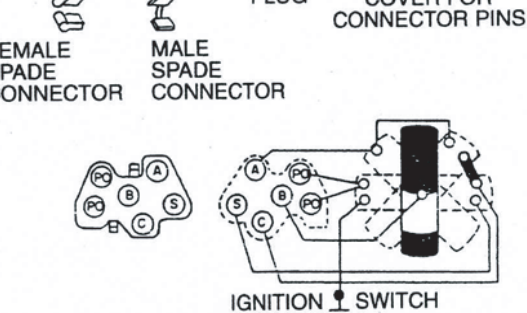
CONNECTOR NOT USED
-  BULLET CONNECTOR
-  SPADE NOT USED
-  FEMALE SPADE CONNECTOR
-  MALE SPADE CONNECTOR
-  MULTIPLE PLUG
-  COVER FOR CONNECTOR PINS
- 

IGNITION SWITCH

- AND/OR \* WIRE FUNCTION NOT APPLICABLE TO THIS CIRCUIT  
 (14), (16) ETC. ALL NUMBERS IN (A), (B) ETC. ALL LETTERS CIRCLED INDICATE CONNECTION LOCATION.  
 ★ TO POWER SOURCE

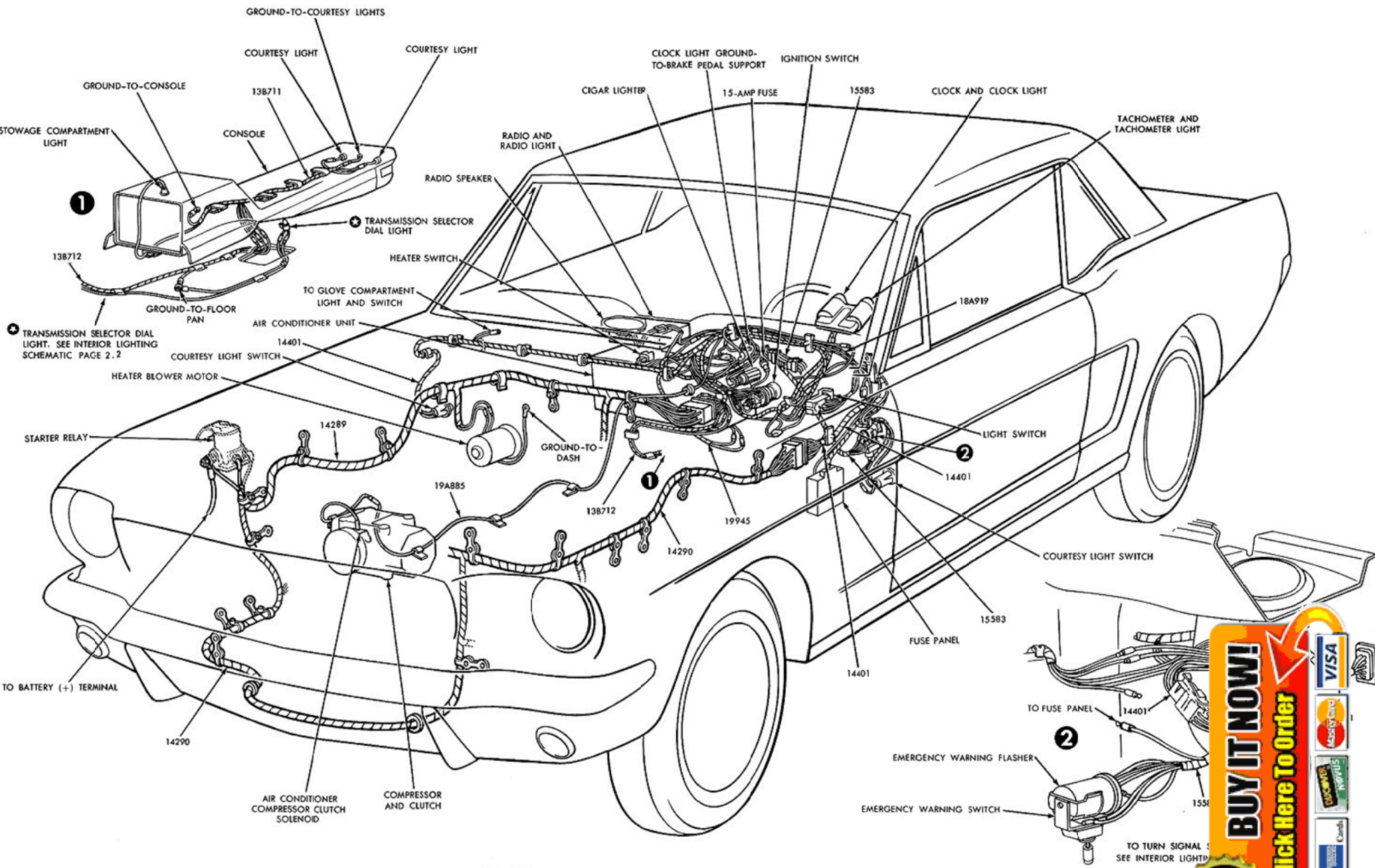

# 1965 MUSTANG ACCESSORIES

**BUY IT NOW!**  
 Click Here To Order

100% SATISFACTION GUARANTEED

VISA  
 MasterCard  
 Discover  
 American Express  
 PayPal

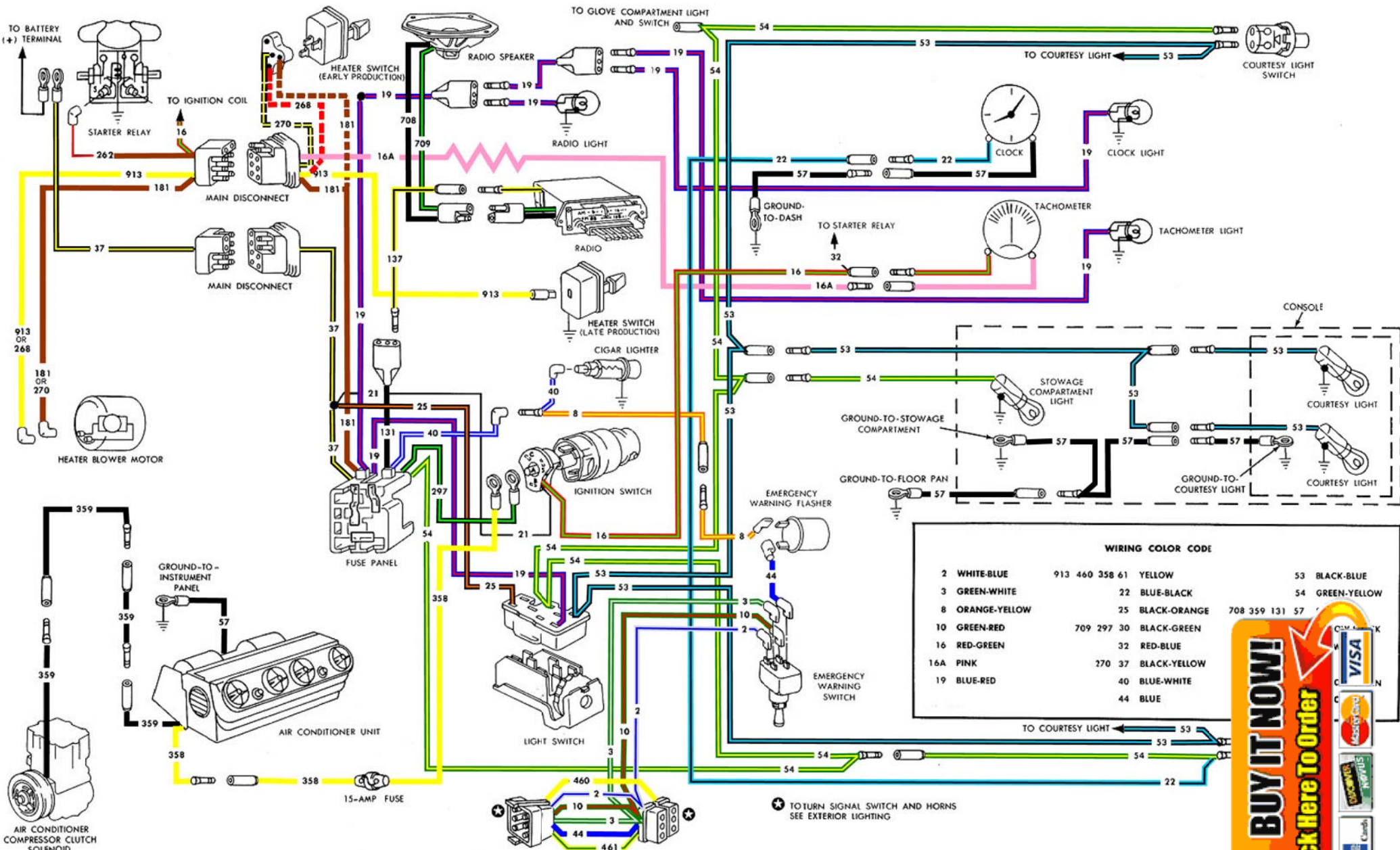

# 1965 MUSTANG ACCESSORIES

**BUY IT NOW!**  
 Click Here To Order

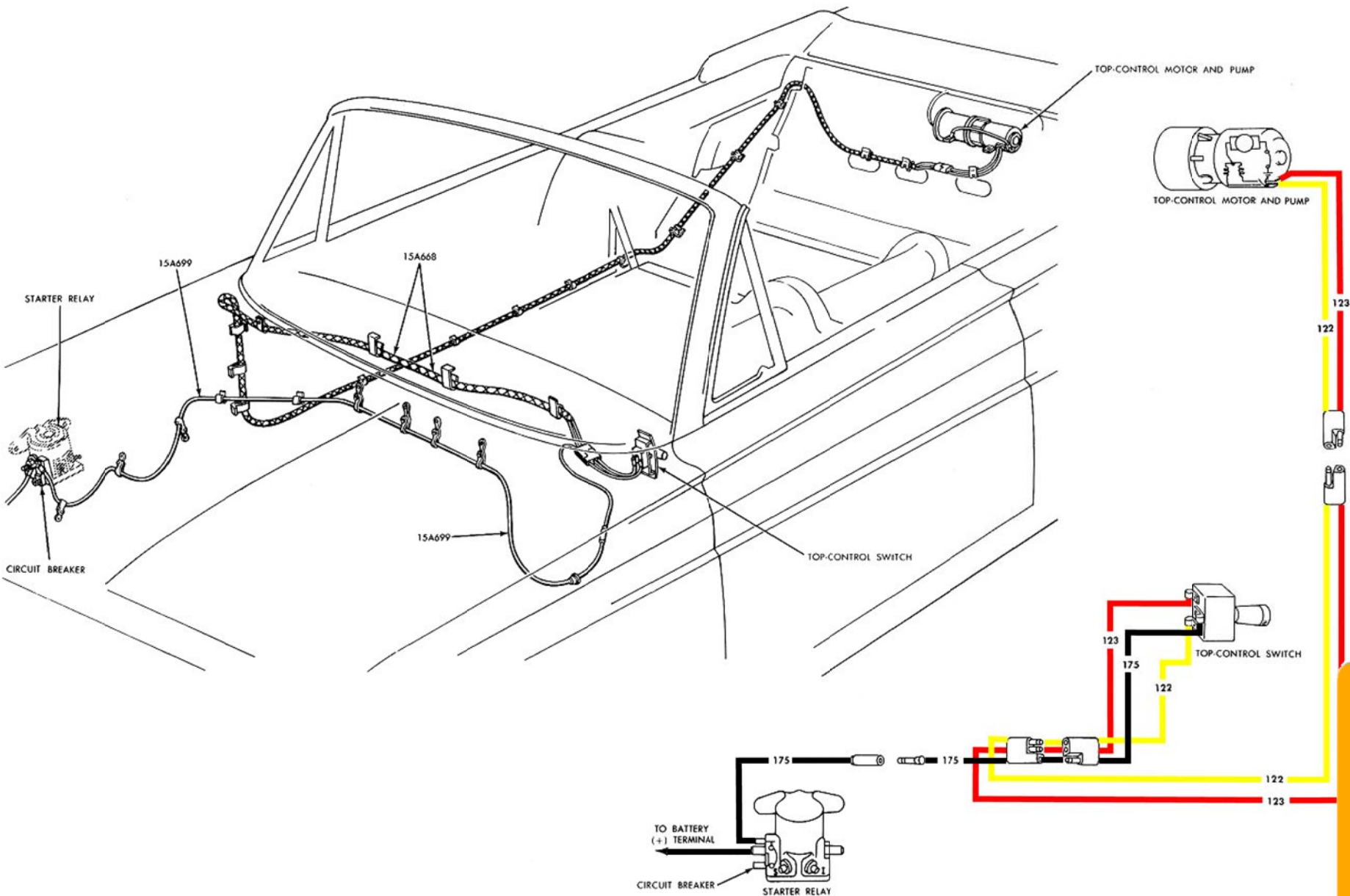

WIRING COLOR CODE	
122	YELLOW
123	RED
175	BLACK

## 1965 FALCON/COMET CONVERTIBLE TOP

**BUY IT NOW!**  
 Click Here To Order

100% SATISFACTION GUARANTEED

# 1965/72 FORD CAR

FINAL ISSUE

Master Parts and Accessories

Source Document  
Ford Publication Form FP-7635-B

Form FP 7635-A & B

Supersedes All Previous Issues, Changes and Revisions



Official Licensed Product

5236

**FINAL ISSUE**



May 1975  
**BUY IT NOW!**

Click Here To Order

Copyright 1975 --

FORD MOTOR  
COMPANY

-- DEARBORN, MICHIGAN

PayPal

Discover  
Cards

Discover  
Novus

MasterCard

VISA



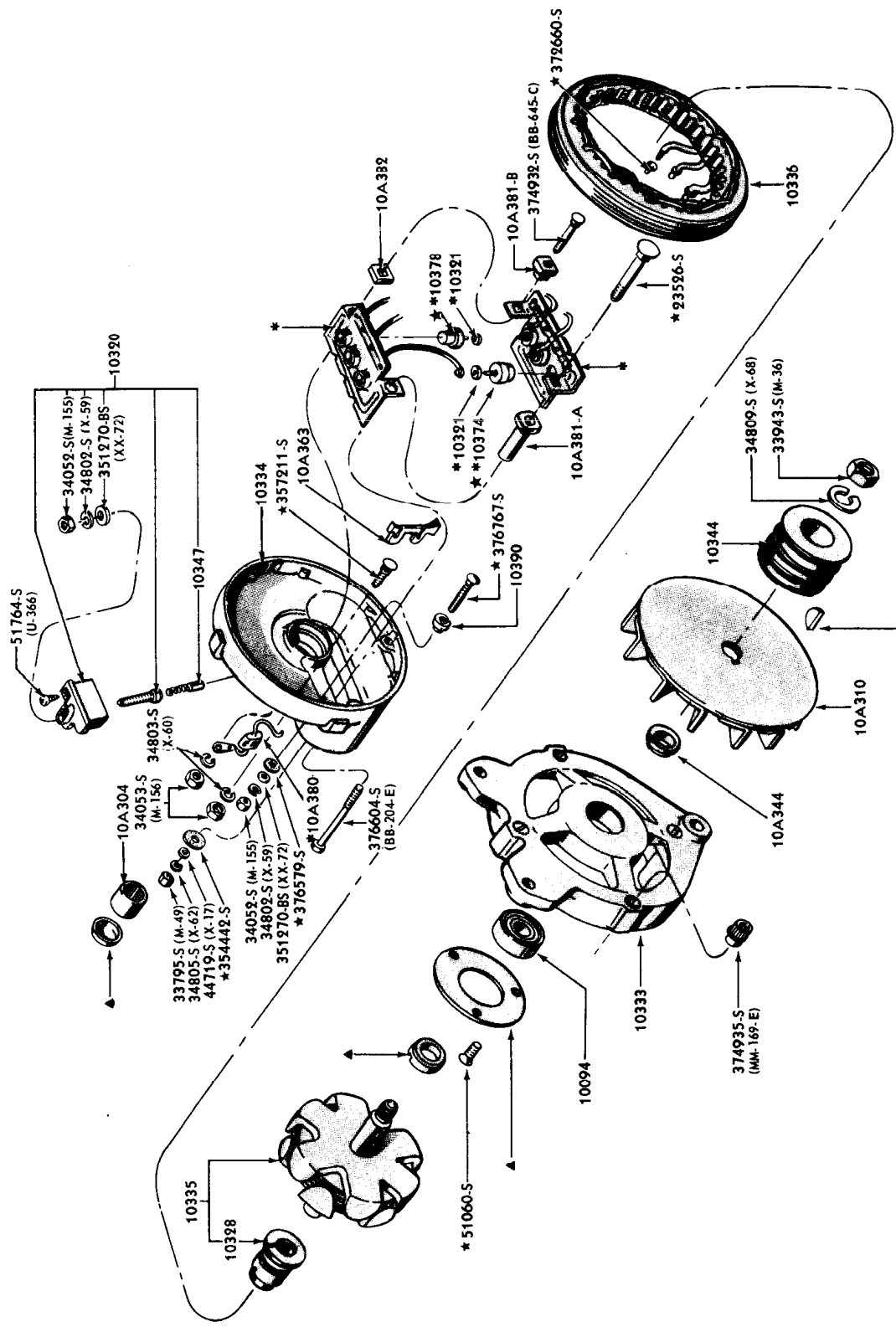

\* ALSO SUPPLIED IN 10304 RECTIFIER ASSEMBLY  
 ▲ SUPPLIED ONLY IN 10346 ALTERNATOR ASSEMBLY

ALTERNATOR (LEECE NEVILLE 15 VOLT - 40,53 AMP.)  
 1965/67

**100% SATISFACTION GUARANTEED**

**BUY IT NOW!**

**Click Here To Order**



READY REFERENCE

13001

# HOW TO READ WIRING DIAGRAMS



VOL 68 S7 L2A

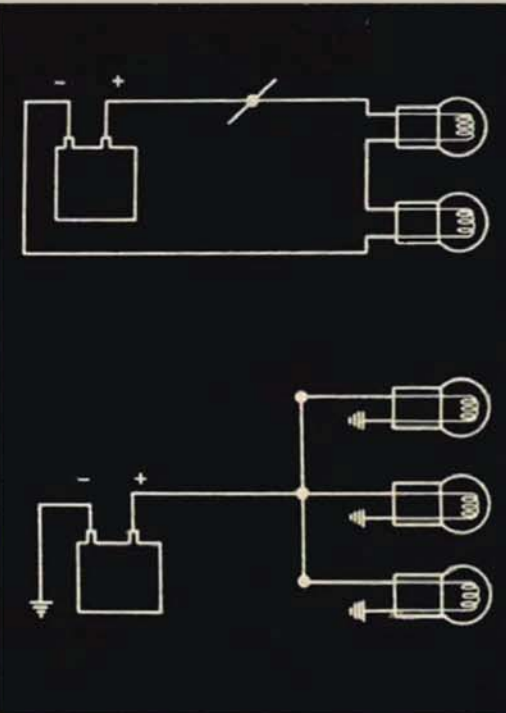

**BUY IT NOW!**

**Click Here To Order**



# HOW TO READ WIRING DIAGRAMS

COURSE 13001 • VOL. 68 S7 L2A

## TABLE OF CONTENTS

Page

### INTRODUCTION

<b>A LOGICAL APPROACH TO ELECTRICAL DIAGNOSIS . . . . .</b>	<b>1</b>
Like reading a road map . . . . .	2
How wires are numbered and color-coded . . . . .	2
<b>CIRCUIT – A COMPLETE ELECTRICAL PATH BETWEEN TWO POINTS . . . . .</b>	<b>5</b>
2-wire circuit . . . . .	6
Single wire circuit . . . . .	6
Ground connections . . . . .	7
<b>OPEN CIRCUITS . . . . .</b>	<b>8</b>
Shorts . . . . .	9
Grounded circuit . . . . .	9
Series and parallel open circuits . . . . .	10
<b>BREAKS IN PARALLEL CIRCUITS . . . . .</b>	<b>11</b>
Common points . . . . .	14
Splices . . . . .	15
Fuses and circuit breakers . . . . .	17
Quick disconnects . . . . .	18
Male and female elements . . . . .	20
Types of quick disconnects . . . . .	22
<b>HINTS FOR TRACING WIRES THROUGH A DRAWING . . . . .</b>	<b>23</b>
Curve directions . . . . .	23
Common points . . . . .	24
Switches . . . . .	25
Relays . . . . .	26
Assemblies . . . . .	28
Locating the assembly . . . . .	29
Finding the wire . . . . .	30
<b>SUMMARY . . . . .</b>	<b>31</b>

**100% SATISFACTION GUARANTEED**

**BUY IT NOW!**

**Click Here To Order**

The descriptions, testing procedures, and specifications in this handbook were approved for printing. Ford Motor Company reserves the right to change specifications without notice and without incurring

NATIONAL SERVICE OFFICE  
FORD DIVISION



FIRST PRINTING – JANUARY, 1968

© 1968 FORD MOTOR COMPANY  
DEARBORN, MICHIGAN

# INTRODUCTION

## *The Why and Wherefore of Wiring Diagrams*

To the uninformed, a wiring diagram — or a wiring assembly — looks like it might take a genius to figure out.

Not so — as you'll find out when you get better acquainted with these subjects.

There're as understandable and logical as a road map and road markers, when you're finding your way on a cross-country drive.

The ability to read a wiring diagram and relate it to a vehicle's wiring system is, of course, an essential part of a modern service technician's skill. And it's growing in relative importance, too, due to owner's increasing demands for the comforts and conveniences supplied by electrically-operated options and accessories. This opens up greater opportunities, for the forward-looking technician.

## *The Purpose of this Booklet . . .*

. . . is to acquaint you with the systems by which electrical circuits are traced on vehicles. Specifically, it is designed to help you acquire the ability to make your own power checks, quickly and accurately.

## *Scope of the Booklet*

Basically, this is a printed version of the film, "How to Read a Wiring Diagram." It is in no sense a manual of the shop methods by which electrical repairs are made.

It *can* be a helpful guide that can introduce you to the principles of wiring diagrams and vehicle wiring. As you gain experience in reading wiring diagrams, you'll accumulate your own know-how in this important skill. When it becomes "second nature" to you, these pages will have served their purpose — and yours.



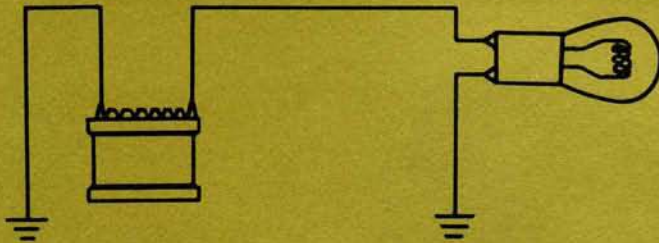

To show how to read wiring diagrams — and to explain how they can be used to help you troubleshoot problems in the electrical system — is what this booklet is all about. Obviously, these are important subjects.

## A LOGICAL APPROACH TO ELECTRICAL DIAGNOSIS



If a customer comes in because his headlights aren't working, you can't just make a snap decision. That's not the *professional way*.



When you go to a doctor, for example, he tries to find out what's *really* wrong with you. He looks beyond the aches and pains you feel, to see what's *causing* the trouble. We call this, *diagnosis*.

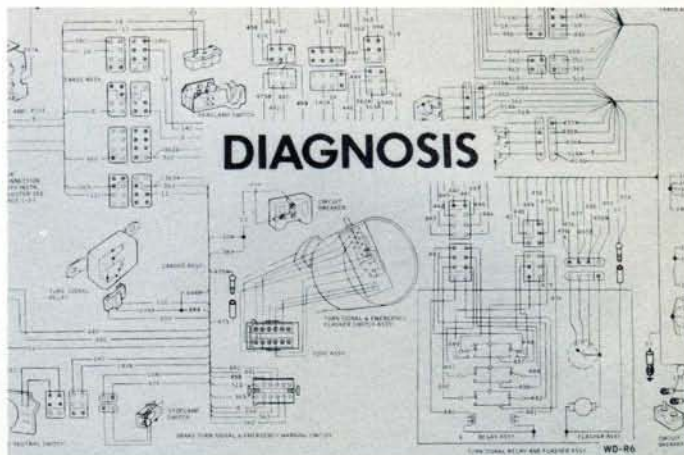

Troubleshooting an electrical system calls for diagnosis, too — *Your* diagnosis. *You're* the doctor. You must find out what's causing the trouble, and fix it.



**BUY IT NOW!**

**Click Here To Order**

unit may be the way may not. Snap professional.

