

1949-1959 FORD CAR PARTS AND ACCESSORIES



TEXT CATALOG

1949-1959 CHASSIS

1953-1959 BODY

100% SATISFACTION GUARANTEED

BUY IT NOW!

Click Here To Order

PARTS AND ACCESSORIES OPERATIONS

FORD MOTOR COMPANY

COMPANY - DEARBORN, MICHIGAN

1964

QUICK REFERENCE INDEX	PAGE
GENERAL INFORMATION	II
MOULDING CLIP KITS	1
SECTIONS 18-24 WHEELS, BRAKES	7
SECTIONS 38-46 FRONT SUSPENSION, STEERING REAR AXLE, DRIVE SHAFT	37
SECTIONS 50-54 FRAME, MUFFLER, SPRINGS	73
SECTIONS 60-68 ENGINE	110
SECTIONS 70-76 STANDARD TRANSMISSION, CLUTCH	147
SECTIONS A70 AUTOMATIC TRANSMISSION	185
SECTIONS 80-85 COOLING, GRILLE	259
SECTIONS 90-97 FUEL, CARBURETOR, ACCELERATOR	287
SECTIONS 100-120 GENERATOR, ALTERNATOR STARTER, DISTRIBUTOR	501
SECTIONS 130-150 LAMPS, WIRING	557
SECTIONS 160-166 FENDER, HOOD	603
SECTIONS 170-190 SPEEDOMETER, BUMPER, ACCESSORIES	621
BODY PARTS INDEX	675
BODY SECTIONS 000-100 BODY FRONT, FLOOR	695
BODY SECTIONS 200-300 SIDE DOOR, PILLAR, QUARTER	719
BODY SECTIONS 400-530 BACK, LUGGAGE COMPARTMENT	805
BODY SECTIONS 600-620 SEATS	865
SOFT TRIM	875

Copyright © 2007, Forel Publishing Company, LLC, Woodbridge, Virginia

All Rights Reserved. No part of this book may be used or reproduced in any manner whatsoever without written permission of Forel Publishing Company, LLC. For information write to Forel Publishing Company, LLC, 3999 Peregrine Ridge Ct., Woodbridge, VA 22192

1949 - 1959 Ford Car Parts and Accessories Catalog
Form FD 9462 and FD 9463

ISBN: 1-60371-022-1
EAN: 978-1-60371-022-0

Forel Publishing Company, LLC
3999 Peregrine Ridge Ct.
Woodbridge, VA 22192
Email address: webmaster@ForelPublishing.com
Website: <http://www.ForelPublishing.com>



This publication contains material that is reproduced and distributed under a license from Ford Motor Company. No further reproduction or distribution of the Ford Motor Company material is allowed without the express written permission of Ford Motor Company.

Disclaimer

Although every effort was made to ensure the accuracy of this book, no representations or warranties of any kind are made concerning the accuracy, completeness or suitability of the information, either expressed or implied. As a result, the information contained within this book should be used as general information only. The author and Forel Publishing Company, LLC shall have neither liability nor responsibility to any person or entity with respect to any loss or damage caused, or alleged to be caused, directly or indirectly by the information contained in this book. Further, the publisher and author are not engaged in rendering legal or other professional services. If legal, mechanical, electrical, or other expert assistance is required, the services of a competent professional should be sought.





PARTS and ACCESSORIES TEXT CA

FORM FD-9462

1949/59 PASSENGER CAR

FORD DIVISION  MOTOR COMPANY

DISTRICT OFFICES

Atlanta (East Point, Ga.)	Denver, Colo.	Louisville, Ky.	Philadelphia (Pennsauken, N. J.)
Boston	Des Moines, Iowa	Memphis, Tenn.	Pittsburgh, Pa.
(Natick, Mass.)	Detroit	New Orleans	Richmond, Va.
Buffalo, N. Y.	(Livonia, Mich.)	(Arabi, La.)	Rockford, Ill.
Charlotte, N. C.	Fargo, N. D.	Newark	St. Louis
Chicago	Houston, Texas	(Teterboro, N. J.)	(Clayton, Mo.)
(Melrose Park, Ill.)	Indianapolis, Ind.	New York	Salt Lake City, Utah
Cincinnati, Ohio	Jacksonville, Fla.	(White Plains, N. Y.)	San Jose, Calif.
Cleveland, Ohio	Kansas City, Mo.	Oklahoma City, Okla.	Seattle, Wash.
Dallas, Texas	Lansing, Mich.	Omaha, Neb.	Twin City
Davenport, Iowa	Los Angeles	Phoenix, Arizona	(Minneapolis, Minn.)
	(Pico-Rivera, Calif.)		Washington, D. C.

INDEX FOR GENERAL INFORMATION SECTION

Abbreviations	XX	Patent Plate Diagram and Explanation	X
Appearance & Maintenance Materials	XVIII, XIX	Patent Plate Codes	
BASIC BODY PARTS NUMBERING SYSTEM	IV	Assembly Plant	XI
Body Type Codes	IV	Body Type	XII
Catalog Format	IV	Body Style	XIII
Catalog Model Codes	III	District	XI
District Offices	II	Engine (Horsepower Rating)	XI
Explanation of Symbol ★	V	Exterior Paint Body Color	XVI, XVII
Ford Group and Basic Number Chart	VI thru IX	Model Year	XI
General Instructions	II	Months of the Year	XI
How to Order Parts	V	Rear Axle Ratio	XI
Model Years	III	Transmission Type	XI
Nomenclature Index	III	Trim Scheme	XIII, XIV, XV
Procedure for Using Catalog	V		
Quick Reference Index	I		
Section, Group and Basic Numbers	III		
Soft Trim	IV		
Standard and Utility Hardware	IV		
Used Car Reconditioning Materials	XIX		

GENERAL INSTRUCTIONS

This Ford Parts and Accessories Catalog contains parts information for the Ford passenger car line including Thunderbird, and is to be used in conjunction with "Illustration" Catalog, Form FD-9463.

Following are the model years for which parts information is provided in this catalog:

Chassis Parts	1949 thru 1959
Body Parts	1953 thru 1959
Soft Trim Parts	1956 thru 1959

The driver's side is the left hand side of the vehicle and should govern in determining such parts as fenders, lamps, etc. as to whether a part is right or left hand.



CATALOG MODEL CODES

Codes shown in the "Text" Catalog under heading "Model" are to be interpreted as follows:

A	Passenger Car	F/M/2	FORDOMATIC 2 SPEED TRANSMISSION	S/C	Supercharger
A/C	Air Conditioner	M/L	Mainline	S/D	*Sedan Delivery
A/S	Air Suspension	O/D	Overdrive	S/L	Sunliner
C/L	Customline	P/I	Police Interceptor	S/T	Standard Transmission
C/M	Cruise-O-Matic	P/L	Parklane	S/W	*Station Wagon
F/L	Fairlane	P/S	Power Steering		
F/M	FORDOMATIC TRANSMISSION	S	Thunderbird		

- ♣ Includes parts common to Station Wagon, Sedan Delivery, Ranchero, Police Interceptor when applicable.
- * Models S/D and S/W when shown separately apply to parts peculiar to Sedan Delivery and Station Wagons.

MODEL YEARS

Model year application is indicated by showing the first year followed by a diagonal line to imply continued usage in all subsequent years until the insertion of the last year of usage, which will then be inserted after the diagonal line. If no diagonal line is shown the illustration is applicable only to the year shown.

Example:	49	indicates part used 1949 model year only.
	49/59	indicates part used 1949 through 1959 model years.
	55/	indicates part used 1955 through 1959 and subsequent model years as indicated in the appropriate catalog for 1959 and up.

SECTION, GROUP and BASIC NUMBERS

For greater convenience this catalog is divided into sections to conform with the Master Parts Catalogs.

Section Numbers are related to group numbers as follows:

SECTION NUMBER	GROUP NUMBER SERIES	PART NAME
10	1000 - 1999	Wheel Parts
20	2000 - 2999	Brake Parts

The "Illustration" Catalog is divided into sections also and like parts are shown under similar numbers in both the "Text" and "Illustrations" catalogs.

Illustrations contain basic group numbers only; therefore, it is necessary to refer to the basic group within the "Text" Catalog listing for complete applicable part number.

Some basic numbers include an alphabetical character in addition to the numerical digits shown in the charts on Page VI. In this catalog basic numbers expanded by an alphabetical character follow the numerical basic numbers from which they are expanded and are listed in the manner shown below:

2150	Bolt - Front Brake Line Connection
2A150	Bushing - Power Brake Booster Lever

Refer to Pages VI thru IX for more information on Ford group and basic part numbers.

NOMENCLATURE INDEX

A nomenclature index appears at the beginning of each major Chassis group listed in the Quick Reference Index shown on the cover and Page I. The Body nomenclature index is shown on pages 675 thru 694 in the beginning of the body area of the catalog.



BASIC BODY PARTS NUMBERING SYSTEM

FOLLOWING IS A DIAGRAM OF THE BASIC BODY PARTS NUMBERING SYSTEM

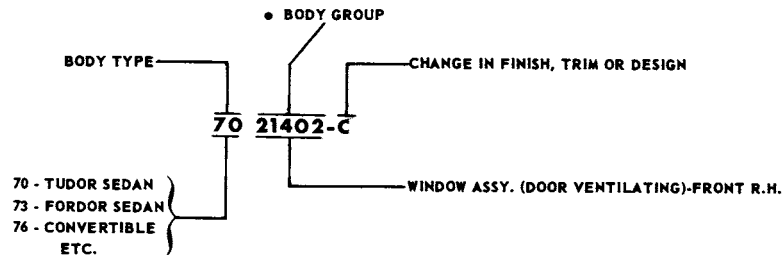

- These five digits comprise the Body Group Numbers as used through each body parts section.

A complete group index of body parts has been included on pages 675 through 694. The index is divided into areas of the car in alphabetical sequence; such as front, back, quarter, roof, doors, etc.

SOFT TRIM

Four sections are devoted to Soft Trim Parts, namely 1956 thru 1959. Each includes only those items which were available for service at the time of printing. To determine the complete part number of a required trim part, it is necessary to have the "Trim Scheme Code" which appears on the patent plate of the vehicle (refer to Pages XIII, XIV and XV). Soft Trim replacement parts are listed on pages 875 thru 908.

BODY TYPE CODES

Most body parts are identified with Body Type Codes. A complete listing of the codes and the body types which they represent is shown on Page XII. Body types which are similar are identified by the same code number; alphabetical suffixes are used to identify a particular body type. For instance, in 1959 Code 58 was used as follows:

BODY TYPE CODE	BODY TYPE
58A	Fairlane Town Sedan
58B	Fairlane "500" Town Sedan
58E	Custom "300" Fordor Sedan

The body type numbers only are shown on those illustrations which are applicable to all body types of a related group. For instance, Body Type Code 58 includes 58A, 58B and 58E.

CATALOG FORMAT

The format is specifically arranged to coincide with the normal procedure for selecting part numbers.

- Column:
1. Model year
 2. Type of vehicle or equipment within a specific model year
 3. Description, size, etc.
 4. Number required per vehicle
 5. Complete part number

STANDARD and UTILITY HARDWARE

Standard and utility hardware, such as bolts, screws, fittings, etc. are listed below the part with which they are used. To facilitate the stocking and handling of Standard and Utility Parts by Ford dealers, locator codes are preassigned by Ford Motor Company. The locator codes are shown in parentheses immediately following or below the standard and utility part numbers.

For an example, refer to Body Section 030, Group 03086. The part number for a No. 8 x 1" cross recess oval head screw is 52344-S13 and the locator code is U292. In the catalog this item will be shown as 52344-S13(U292).

FORD CAR PARTS



EXPLANATION OF SYMBOL ★

★ Symbol indicates part is not supplied for service due to the following:

- A. Part is superseded and replaced as indicated in the description column of the text.
- B. Part can be improvised as indicated in the description column of text.
- C. Due to its function there would be little or no demand.

Always refer to the description column of the text for possible substitution, or for material specifications and dimension which may be helpful in obtaining the non-serviced part locally.

HOW TO ORDER PARTS

When ordering parts, always give the complete part number.

In the event the part number is not known, the following information should be included.

- A. Complete description of part.
- B. Model year and body type.
- C. Dimension, number of teeth, size, etc.; if possible rough sketch of part.
- D. If applicable to engine, transmission, axle, steering, etc.; specify type; such as 312 cubic inch, Fordomatic, Power Steering, etc.
- E. Advise how shipment is to be made - Freight, Express, Air, Parcel Post.

PROCEDURE FOR USING CATALOG

Following is a recommended procedure for using this catalog:

Should an inquiry be received for a grease baffle for the brakes of a 1955 passenger model vehicle, use the following steps.

- A. Refer to the section and page designated in the Quick Reference Index on the cover for "Brakes".
- B. On the designated page (7) will be an index.
- C. Refer to the alphabetical nomenclature under heading "Brake System"; find name Baffle (Front Grease). The group number will be shown as 2060.
- D. Refer to Group 2060 and locate the year 1955 in the column head "Year". Refer then to column headed "Model" for "A" which indicated passenger car. The part number will be shown as AD 2060-C.

In the event the proper nomenclature is in doubt, an alternate method of locating basic part number would be as follows:

- A. Refer to the section and page designated in the Quick Reference Index of the Illustration Catalog for "Brakes".
 - B. On the designated Page 28 is an index of various Front and Rear Brakes.
 - C. Locate the front and rear brakes applicable to 1955 which is on Page 41 of the Illustration Catalog.
 - D. Refer to illustration on Page 41 and identify the proper part which will show the group number as 2060.
 - E. Refer to Group 2060 of this catalog and locate the year 1955 in the column headed "Year". Refer then to column headed "Model" for "A" which indicates passenger car. The part number will be shown as AD 2060-C.
-



FORD GROUP AND BASIC PART NUMBERS

Ford group and basic part numbers are grouped according to their function; for example, all parts applying to the rear axle are grouped from 4000 to 4296, transmission and clutch from 6905 to 7997, etc.

Following is an index and section number of the various groups--

GROUP AND BASIC PART NO. SERIES	GROUP NAME	SECTION	GROUP AND BASIC PART NO. SERIES	GROUP NAME	SECTION
1000-1250	Wheels, hubs and drums	10	11000-11382	Starter motor	110
1350-1499	Spare wheel carrier	10	11450-11688	Lighting & ignition switch	110
2001-2285	Brakes (service)	20, 22	12000-12390	Ignition coil, distributor, condenser	120
2307-2438	Brakes (power)	23	12402-12425	Spark plug	120
2442-2482	Brake controls	24	13002-13248	Lamps (head and parking)	130
2505-2900	Brakes (parking)	24			
			13402-13796	Lamps (rear)	134, 137
			13809-13853	Lamps (license and pillar) & horn	137
3000-3359	Front suspension and steering linkage	30	14197-14689	Wiring	140, 145
3500-3764	Steering gear	35, 36	15000-15858	Miscellaneous accessories	150
4000-4296	Rear axle	40	16000-16550	Front fender	160
4600-4859	Drive shaft	46			
5000-5176	Frame	50	16600-16999	Hood	166
			17005-17125	Tools	170
5200-5299	Muffler & exhaust pipe	52	17248-17383	Speedometer & tachometer	170, 172
5300-5499	Front spring & stabilizer	53	17402-17666	Windshield wiper & washer	172, 175, 176
5550-5832	Rear spring	53	17700-17730	Mirror	176
6000-6898	Engine	60, 61, 62, 63, 65, 66	17736-17999	Bumper	176
6905-6968	Transmission overdrive & engine steady rest	69, 70			
			18000-18125	Shock absorber	180
			18148-18994	Miscellaneous accessories	180, 182, 184
7000-7997	Transmission and clutch	70, 71, 72, 73, 75, 76	19500-19585	Appearance and maintenance materials	Paint
7000-7997	Automatic Transmission	A70, A71, A72, A73, A75, A76	19600-19980	Air conditioner	190
8000-8499	Radiator and grille	80	4000000 & Up	Body Parts	
8500-8689	Water pump and fan	85			
			BODY SECTION		
9002-9296	Fuel tank & supercharger	90		Body front	000
9301-9420	Fuel pump	93, 94		Windshield	030
9421-9499	Manifolds, clamps, etc.	94		Instrument panel	042
				Floor	100
9500-9599	Carburetor & supercharger	95, 95A, 95B		Front door	200, 210, 220, 230
9600-9699	Air cleaner	96		Rear door	240, 260
9700-9999	Accelerator & choke control rods	97			
				Quarter	270, 280, 290, 295, 300
10000-10449	Generator & Alternator	100		Back window and luggage compartment	400, 420, 430, 440
10500-10653	Voltage regulator	100, 106			
10654-10756	Battery	106		Roof, folding top	500, 510, 520, 530
10838-10990	Instruments	106		Seats	600, 610, 620

FORD CAR PARTS

FORD MOTOR COMPANY BASIC PART NUMBER CHASSIS, ENGINE AND ELECTRICAL BASIC NUMBER



BASIC PART NO. SERIES	BASIC SERIES EXPANSION	PARTS WHICH QUALIFY BY FUNCTIONAL AREA	BASIC PART NO. SERIES	BASIC SERIES EXPANSION	PARTS WHICH QUALIFY BY FUNCTIONAL AREA
1000-1250 1251-1349 1350-1499 1500-1724 1725-1999 2000-2594 2595-2874 2875-2999 3000-3499 3500-3776	1A000-1A250 1A251-1A349 1A350-1A499 1A500-1A724 1A725-1A999 2A000-2A594 2A595-2A874 2A875-2A999 3A000-3A499 3A500-3A776	Wheels, Hubs, and Drums Open Numbers Spare Wheel Carrier Tires and Tubes Open Numbers Brakes Brakes—Parking Air Compressor Front Axles and Front Suspensions Steering Gear and Steering Wheel	12450-12499 12500-12599 12600-12999 13000-13199 13200-13299 13000-13399 13400-13699 13700-13799 13800-13949 13950-13999	12A450-12A499 12A500-12A599 12A600-12A999 13A000-13A199 13A200-13A299 13A300-13A399 13A400-13A699 13A700-13A799 13A800-13A949 13A950-13A999	Engine Governor Open Numbers Open Numbers Head Lamps Parking Lamps Turn Signal License, Tail, and Stop Lamps Courtesy, Dome, and Instrument Lamps and Switches Horn Open Numbers
3777-3999 4000-4999 5000-5149 5150-5199 5200-5299 5300-5350 5351-5416 5417-5454 5455-5481 5482-5499	3A777-3A999 4A000-4A999 5A000-5A149 5A150-5A199 5A200-5A299 5A300-5A350 5A351-5A416 5A417-5A454 5A455-5A481 5A482-5A499	Open Numbers Rear Axle and Driveshaft and Coupling Shaft Frame and Brackets * Muffler, Exhaust Pipes, and Brackets Front Springs Sub-Frame (For Cab Mounting) Open Numbers Front Springs—Clips, Studs, and Bushings Stabilizer and Attaching Parts	14000-14689 14690-14724 14725-14999 15000-15039 15040-15074 15075-15114 15115-15199 15200-15299 15300-15399 15400-15489	14A000-14A689 14A690-14A724 14A725-14A999 15A000-15A039 15A040-15A074 15A075-15A114 15A115-15A199 15A200-15A299 15A300-15A399 15A400-15A489	Wiring and Circuit Breakers, Terminals and Connectors, Window Regulator, Fuse Panel Seat Regulator (Electrical) Junction Boxes and Electric Conduit Clocks Cigar Lighter Lamp Assy.—Cluster * Road Lamps Spot Lamps Lamp Assy.—Marker
5500-5515 5516-5999 6000-6899 6900-6944 6945-6999 7000-7499 7500-7649 7650-7799 7800-7999 8000-8499	5A500-5A515 5A516-5A999 6A000-6A899 6A900-6A944 6A945-6A999 7A000-7A499 7A500-7A649 7A650-7A799 7A800-7A999 8A000-8A499	Front Spring Covers Rear Springs and Attaching Parts Engine and Mounts * Engine Installation and Dress-up Kits Transmission and Shifting Controls Clutch and Controls Transmission Overdrive Torque Converter Radiator and Grille Parts	15490-15549 15550-15579 15580-15599 15600-15649 15650-15655 15656-15699 15700-15724 15725-15759 15760-15799 15800-15849	15A490-15A549 15A550-15A579 15A580-15A599 15A600-15A649 15A650-15A655 15A656-15A699 15A700-15A724 15A725-15A759 15A760-15A799 15A800-15A849	Lamp Assy.—Back-up Lamp Assy.—Utility Lamp Assy.—Police Flasher * Map Lamp Top Control Engine Compartment Lamp Commercial Pump Motors Note: Not used Passenger Car, Truck & Industrial Engines Open Numbers Lamp Assy.—Transmission Control Selector Indicator
8500-8599 8600-8669 8670-8999 9000-9269 9270-9339 9340-9423 9424-9499 9500-9599 9600-9699 9700-9899	8A500-8A599 8A600-8A669 8A670-8A999 9A000-9A269 9A270-9A339 9A340-9A423 9A424-9A499 9A500-9A599 9A600-9A699 9A700-9A899	Water Pumps Fan and Brackets Open Numbers Fuel Tank Fuel and Oil Gauges and Fuel Tubes Fuel Pumps Manifold, Clamps, Thermostats, etc. Carburetors Carburetor Air Cleaners Thermostatic Choke, Acc. Spark & Throttle Control Rods	15850-15874 15875-15899 15900-15999 16000-16249 16250-16299 16300-16449 16450-16549 16550-16579 16580-16599 16600-16999	15A850-15A874 15A875-15A899 15A900-15A999 16A000-16A249 16A250-16A299 16A300-16A449 16A450-16A549 16A550-16A579 16A580-16A599 16A600-16A999	Parking Brake Signal Open Numbers * Front Fender and Aprons Fender Shields Rear Fenders Running Boards and Brackets Splash Shields Open Numbers Hood, Brackets, and Controls
9900-9999 10000-10299 10300-10399 10400-10499 10500-10649 10650-10837 10838-10999 11000-11529 11530-11568 11569-11619	9A900-9A999 10A000-10A299 10A300-10A399 10A400-10A499 10A500-10A649 10A650-10A837 10A838-10A999 11A000-11A529 11A530-11A568 11A569-11A619	* Generators Alternator and Rectifier Open Numbers Generator Regulator Battery and Supports—Voltmeter and Charge Indicator Instrument Cluster and Controls Starting Motor and Starter Switch Open Numbers Ignition Switch	17000-17149 17150-17249 17250-17384 17385-17399 17400-17424 17425-17599 17600-17674 17675-17748 17749-17999	17A000-17A149 17A150-17A249 17A250-17A384 17A385-17A399 17A400-17A424 17A425-17A599 17A600-17A674 17A675-17A748 17A749-17A999	Tools Open Numbers Speedometer and Tachometer Open Numbers Rear Window Wiper Windshield Wipers Windshield Washers Rear View Mirrors Front and Rear Bumpers and Stone Deflectors
11620-11644 11645-11688 11689-11999 12000-12399 12400-12427 12428-12449	11A620-11A644 11A645-11A688 11A689-11A999 12A000-12A399 12A400-12A427 12A428-12A449	Open Numbers Lighting Switch Open Numbers Ignition Coil, Distributor, Condenser and Diaphragm Spark Plugs Open Numbers	18000-18199 18200-18241 18242-18699 18700-18799 18800-19499 19500-19549 19550-19999	18A000-18A199 18A200-18A241 18A242-18A699 18A700-18A799 18A800-19A499 19A500-19A549 19A550-19A999	Shock Absorbers * Heaters Air Brakes Radio Miscellaneous Accessories Air Conditioners

*This series has become inactive and parts qualifying will be identified with part numbers from a more appropriate series.



Click Here To Order

BUY IT NOW!



BODY BASIC NUMBERS AND CORRESPONDING FU

BASIC PART NO. SERIES	BASIC SERIES EXPANSION	PARTS WHICH QUALIFY BY FUNCTIONAL AREA	BASIC PART NO. SERIES	SERIES EXPANSION	BY FUNCTIONAL AREA
*7000000-7000099 00100-00399 01400-01499 01500-01599 01600-01799 01800-01999 02000-02499 02500-02699 02700-02899 02900-02999 03000-03999 04000-04249 04250-04399 04400-04599	7000A00-7000A99 001A00-003A99 014A00-014A99 015A00-015A99 016A00-017A99 018A00-019A99 020A00-024A99 025A00-026A99 027A00-028A99 029A00-029A99 030A00-039A99 040A00-042A49 042A50-043A99 044A00-045A99	Body Assembly & Trim Sets Front End Assembly Ventilating Ducts & Valves Brake Pedal Support Dash Assembly Ventilating Ducts & Valves Cowl Assembly Front Body Pillar Assy. Open Body Front Tie Bow Braces, Etc. Windshield Assembly Visor Assembly Front Belt Rail Inst. Panel Assy. Panel Assy.—Instr. Panel Details	25000-25099 25100-25299 25300-25399 25400-25699 25700-25899 25900-25999 26000-26199 26200-26399 26400-26599 26600-26699 26700-26799 26800-26899 26900-26999 27000-27199	250A00-250A99 251A00-252A99 253A00-253A99 254A00-256A99 257A00-258A99 259A00-259A99 260A00-261A99 262A00-263A99 264A00-265A99 266A00-266A99 267A00-267A99 268A00-268A99 269A00-269A99 270A00-271A99	Rear Door Frame & Pillar Assy. Rear Door Header Rear Door Bottom Rear Door Garnish Moulding Rear Door Glass Open Rear Door Reinf. Rear Door Glass Frame Rear Door Lock Rear Door Handles Open Rear Door Hinge Open Rear Door Regulator
04600-04799 04800-04899 04900-05999 06000-06199 06200-09999 *7010000-7010099 10100-10599 10600-10999 11000-11099 11100-11399 11400-11499 11500-11799 11800-11999 12000-12099	046A00-047A99 048A00-048A99 049A00-059A99 060A00-061A99 062A00-099A99 70100A00-70100A99 101A00-105A99 106A00-109A99 110A00-110A99 111A00-113A99 114A00-114A99 115A00-117A99 118A00-119A99 120A00-120A99	Cigar Lighter Assy. & Instrument Cluster Ash Receptacle Assy. Open Glove Compt. Assy. Open Floor Assembly Floor Side Member Assy. Floor Cross Sill Assy. Under Body Assy Floor Pan Assembly Floor Pan Silencers & Pads Floor Board Assy. Open Floor Board Riser	27200-27299 27300-27399 27400-27699 27700-27799 27800-28099 28100-28399 28400-28499 28500-28599 28600-28699 28700-28799 28800-28999 29000-29199 29200-29599 29600-29699	272A00-272A99 273A00-273A99 274A00-276A99 277A00-277A99 278A00-280A99 281A00-283A99 284A00-284A99 285A00-285A99 286A00-286A99 287A00-287A99 288A00-289A99 290A00-291A99 292A00-295A99 296A00-296A99	Rear Door Check Rear Door Regulator Vacuum Lift Rear Door Trim Quarter Assy. Quarter Panel Assy. Quarter Lock Pillar Open Quarter Header Quarter Frame Quarter Belt Rail Open Quarter Window Garnish Moulding & Moulding Quarter Reinf. Braces & Brkts. Quarter Window Assy.
12100-12299 12300-12599 12600-12699 12700-12999 13000-13199 13200-13299 13300-13499 13500-13599 13600-13799 14000-14099 14100-14199 14200-14299 14300-19999 *7020000-7020099	121A00-122A99 123A00-125A99 126A00-126A99 127A00-129A99 130A00-131A99 132A00-132A99 133A00-134A99 135A00-135A99 136A00-137A99 140A00-140A99 141A00-141A99 142A00-142A99 143A00-199A99 70200A00-70200A99	Floor Trans. Cover Dust Sealer Open Floor Skid Strip Open Floor Mat & Carpet Floor Scuff Plate Open Floor Tool Box Open Member Assy.—Body Side Front Member Assy.—Body Side Rear Sill Assy.—Floor Pan Cross Front Open Body Side Assembly	29700-29799 29800-29999 7030000-7030199 30200-30299 30300-30499 30500-30699 30700-30799 30800-30999 31000-31499 31500-31599 31600-31899 31900-31999 32000-32199 32200-32399	297A00-297A99 298A00-299A99 70300A00-70301A99 302A00-302A99 303A00-304A99 305A00-306A99 307A00-307A99 308A00-309A99 310A00-314A99 315A00-315A99 316A00-318A99 319A00-319A99 320A00-321A99 322A00-323A99	Quarter Window Glass Quarter Glass Channel Quarter Glass Run Quarter Window Reg. Quarter Vent. Window Quarter Window Regulator Quarter Glass Frame Quarter Arm Rest Ash Receptacle Open Quarter Trim Assy. & Assist Loop Open Qtr. Arm Rest Assy. & Rear Seat Center Arm Rest Quarter Panel Spare Wheel Compt. Open Side Slats—Trim Sticks—Anti-Squeaks
20100-20199 20200-20399 20400-20499 20500-20699 20700-20799 20800-21099 21100-21299 21300-21399 21400-21799 21800-22199 22200-22399 22400-22499 22500-22599 22600-22699	201A00-201A99 202A00-203A99 204A00-204A99 205A00-206A99 207A00-207A99 208A00-210A99 211A00-212A99 213A00-213A99 214A00-217A99 218A00-221A99 222A00-223A99 224A00-224A99 225A00-225A99 226A00-226A99	Front Door Front Door Panel Front Door Pillar Front Door Header Front Door Bottom Front Door Garnish Mldg. & Mldgs. Front Door Reinf. Open Front Door Glass Front Door Lock Front Door—Glass Frame Front Door Handles Open Front Door Handles—Inside	32400-32499 32500-39999 7040000-7040099 40100-40199 40200-40299 40300-40399 40400-40499 40500-40599 40600-40699 40700-40799 40800-40899 40900-40999 41000-41099 41100-41199	324A00-324A99 325A00-399A99 70400A00-70400A99 401A00-401A99 402A00-402A99 403A00-403A99 404A00-404A99 405A00-405A99 406A00-406A99 407A00-407A99 408A00-408A99 409A00-409A99 410A00-410A99 411A00-411A99	Quarter Folding Compt.—Package Open Back Door Assembly Luggage Compt. Door Assy. Tail Gate Assy. Back Panel Assy. Lift Gate Open Luggage Compt. Door Panel Tail Gate Panel Assy. Back Door Frame Assy. Tail Gate Frame Assy. Back Door Pillar Fillers Open
22700-22799 22800-22899 22900-22999 23000-23099 23100-23399 23400-23499 23500-23599 23600-23699 23700-23999 24000-24199 24200-24299 24300-24599 24600-24699 24700-24999	227A00-227A99 228A00-228A99 229A00-229A99 230A00-230A99 231A00-233A99 234A00-234A99 235A00-235A99 236A00-236A99 237A00-239A99 240A00-241A99 242A00-242A99 243A00-245A99 246A00-246A99 247A00-249A99	Open Front Door Hinge Front Door Ventilating Window Front Door Dovetail Front Door Regulator Front Door Window Regulator Front Door Check Open Front Door Trim Front Door Arm Rest Hydraulic Window Operating Center Pillar Assy. Rear Door Assy. Rear Door Panels	41200-41299 41300-41399 41400-41599 41600-41699 41700-41899 41900-41999 42000-42199 42200-42299 42300-42499 42500-42599 42600-42699 42700-42899 42900-42999	412A00-412A99 413A00-413A99 414A00-415A99 416A00-416A99 417A00-418A99 419A00-419A99 420A00-421A99 422A00-422A99 423A00-424A99 425A00-425A99 426A00-426A99 427A00-428A99 429A00-429A99	Deck Pillar Group Luggage Compt. & Lift Gate Door Header Open Tail Gate Framing Back Belt Rail Back Door Glass & Framing Back Window Glass Back Window Frame Assy. Back Window Garnish Moulding Back Door Finish Strip—Mouldings Tail Gate Cross Finish Strip Luggage Compt. Hinge Assy.—Lamp Assy. Back Door Hinge & Reinf. Assy.

FORD CAR PARTS



Click Here To Order

BUY IT NOW!



BODY BASIC NUMBERS AND CORRESPONDING FUNCTIONAL AREA

BASIC PART NO. SERIES	BASIC SERIES EXPANSION	PARTS WHICH QUALIFY BY FUNCTIONAL AREA	BASIC PART NO. SERIES	BASIC SERIES EXPANSION	PARTS WHICH QUALIFY BY FUNCTIONAL AREA
43000-43099	430A00-430A99	Tail Gate Hinge Assy.	54900-54999	549A00-549A99	Roof Ventilator
43100-43149	431A00-431A49	Back Door Lock Assy.	55000-55199	550A00-551A99	Top Luggage Carrier
43150-43199	431A50-431A99	Tail Gate Lock Assy.	55200-55999	552A00-559A99	Open
43200-43399	432A00-433A99	Luggage Compt. Lock Assy.	7060000-7060024	70600A00-70600A24	Front Seat Assy. Compt. Less Trim
43400-43499	434A00-434A99	Back Door Handle Assembly	60025-60049	600A25-600A49	Rear Seat Assy.—Opera Seat Assy.
43500-43699	435A00-436A99	Luggage Compt. Locking Handle	60050-60074	600A50-600A74	Front Seat Assy.
43700-43799	437A00-437A99	Back Door Weatherstrip	60075-60099	600A75-600A99	Rear Seat Cushion Assy.
43800-43899	438A00-438A99	Luggage Compt., Bumper & Weatherstrip	60100-60124	601A00-601A24	Driver's Seat Adjustment
43900-43999	439A00-439A99	Tail Gate Bumper & Dowel	60125-60199	601A25-601A99	Rear Seat Back Assy.—Deck Seat Back Assy.
44000-44099	440A00-440A99	Back Window Regulator Assy.	60200-60299	602A00-602A99	Driver's Seat Back Assy. Comp.
44100-44199	441A00-441A99	Back Door Check Assy.	60300-60499	603A00-604A99	Front Seat Cushion Frame Assy.
44200-44299	442A00-442A99	Luggage Compt. Lid Support—Clamp	60500-60799	605A00-607A99	Rear Seat Cushion Framing
44300-44399	443A00-443A99	Open	60800-60999	608A00-609A99	Aux. Seat Cushion Framing
44400-44599	444A00-445A99	Tail Gate Support	61000-61299	610A00-612A99	Opera Seat Cushion Framing
					Driver's Seat Cushion Framing
					Front Seat Back Framing
44600-44699	446A00-446A99	Back Reinf. Brackets	61300-61399	613A00-613A99	Rear Seat Back Frame
44700-44799	447A00-447A99	Back Door Reinf.	61400-61499	614A00-614A99	Rear Seat Side Pillar—Front Seat Side Board
44800-44999	448A00-449A99	Luggage Compt. Opening Reinf.	61500-61599	615A00-615A99	Rear Seat Side Panel
45000-45099	450A00-450A99	Tail Gate Reinforcement	61600-61699	616A00-616A99	Front Seat Back Panel
45100-45199	451A00-451A99	Luggage Compt. Drain Trough, Back Trim	61700-61899	617A00-618A99	Front Seat Adjusting
45200-45299	452A00-452A99	Back Curtain	61900-62099	619A00-620A99	Driver's Seat Adjustment
45300-45399	453A00-453A99	Luggage Compt. Trim	62100-62299	621A00-622A99	Front Seat Back Reinf.
45400-45599	454A00-455A99	Luggage Tool Compt.	62300-62399	623A00-623A99	Driver's Back Reinf.
45600-45699	456A00-456A99	Luggage Compt. Partition Board	62400-62499	624A00-624A99	Rear Seat Back Reinf.
45700-45799	457A00-457A99	Luggage Compt. Shelf Board	62500-62599	625A00-625A99	Driver & Passenger Seat Support
45800-45899	458A00-458A99	Luggage Compt. Lamp Assy.	62600-62799	626A00-627A99	Rear Seat Legs
45900-45999	459A00-459A99	Luggage Compartment Package Compt.	62800-62899	628A00-628A99	Front Seat Floor Rest Toe Guard
46000-46099	460A00-460A99	Tool Compt.	62900-63199	629A00-631A99	Front Seat Back Robe Cord
46100-46199	461A00-461A99	Deck Step			Front Seat Back Ash Receptacle
46200-46299	462A00-462A99				Front Seat Cushion Cover—Center Seat Opera Seat Cushion
46300-46399	463A00-463A99	Back Door Trim	63100-63199	631A00-631A99	Front Seat Cushion Spring—Center Seat
46400-46499	464A00-464A99	Luggage Compt. Trim			Opera Seat Cushion Spring
46500-46999	465A00-469A99	Package Tray			Rear Seat Cushion Spring
47000-47299	470A00-472A99	Spare Wheel Compartment	63200-63299	632A00-632A99	Seat Cushion Pad
47300-47999	473A00-479A99	Open	63300-63399	633A00-633A99	Seat Cushion Facing
48000-48099	480A00-480A99	Rear Rack Assy.	63400-63499	634A00-634A99	Seat Cushion End Pipe
48100-49999	481A00-499A99	Open	63500-63599	635A00-635A99	Cushion Button
7050000-7050099	70500A00-70500A99	Roof Assy.	63600-63699	636A00-636A99	Seat Cushion Welt Binding
50100-50199	501A00-501A99	Top Assy.	63700-63799	637A00-637A99	Front Seat Side Carpet
50200-50299	502A00-502A99	Roof Panel Assy.	63800-63899	638A00-638A99	Rear Seat Cushion Cover
50300-50599	503A00-505A99	Top Slat Iron			Deck Seat Cushion Cover
50600-50799	506A00-507A99	Top Operating Mechanism	64000-64099	640A00-640A99	Driver's Seat Rear Cover
50800-51299	508A00-512A99	Roof Reinf. Retainers	64200-64399	642A00-643A99	Partition Window Operating Mechl.
51300-51399	513A00-513A99	Roof Rail Assembly	64400-64599	644A00-645A99	Front Seat Back Cushion Cover
51400-51599	514A00-515A99	Top Bow Assy. & Dome Lamp—Brkts. & Att. Parts	64600-64699	646A00-646A99	Seat Back & Pad Assy.
					Seat Back Division Frame
51600-51699	516A00-516A99	Roof Rib & Slats	64700-64799	647A00-647A99	Front Seat Back Spring—Center Seat
51700-51799	517A00-517A99	Roof Drip & Finish Moulding	64800-64899	648A00-648A99	Front Seat Back Pad
51800-51899	518A00-518A99	Roof Partition	64900-64999	649A00-649A99	Front Seat Back Cardboard
51900-51999	519A00-519A99	Roof Trim Panel Headlining			Opera Seat Cardboard Cover
52100-52299	521A00-522A99	Roof Headlining Support	65000-65099	650A00-650A99	Etc., Center Seat
52300-52399	523A00-523A99	Roof Binding	65100-65199	651A00-651A99	Front Seat Back Facing
52400-52499	524A00-524A99	Roof Cardboard	65200-65299	652A00-652A99	Front Seat Back Trim Rail
52500-52599	525A00-525A99	Top Back Curtain			Front Seat Back Cushion Welt & Mldg.
52600-52699	526A00-526A99	Open	65300-65399	653A00-653A99	Front Seat Back Wadding
52700-52999	527A00-529A99	Top Deck & Slide Quarter	65400-65499	654A00-654A99	Front Seat Back Misc. Trim—Hassock Assy.
53000-53099	530A00-530A99	Top Stack—Toggle			Front Seat Back Bellows
53100-53199	531A00-531A99	Top Landau—Folding Pillar	65500-65599	655A00-655A99	Open
53200-53299	532A00-532A99	Top Back Curtain	65600-65999	656A00-659A99	Pedestal Seat
53300-53399	533A00-533A99	Hydraulic Group	66000-66099	660A00-660A99	Open
53400-53499	534A00-534A99	Top Curtain Container	66100-66599	661A00-665A99	Rear Seat Back Cover
			66600-66699	666A00-666A99	Deck Seat Back Cover
53500-53599	535A00-535A99	Top Side Front Curtain	66700-66799	667A00-667A99	Rear Seat Back Spring
53600-53699	536A00-536A99	Top Side Rear Curtain			Deck Seat Back Spring
53700-53799	537A00-537A99	Top Covers, Pads and Retainers	66800-66899	668A00-668A99	Rear Seat Back Pad
53800-53899	538A00-538A99	Quarter Curtain			Deck Seat Back Pad
53900-54199	539A00-541A99	Folding Top	66900-66999	669A00-669A99	Rear Seat Cardboard
54200-54299	542A00-542A99	Top Back Stay	67000-67099	670A00-670A99	Rear Seat Back Facing
54300-54399	543A00-543A99	Roof Pads & Wadding—Silencers	67100-67199	671A00-671A99	Rear Seat Back Center Arm Rest Cover
54400-54499	544A00-544A99	Top Dust Hood & Container			Rear Seat Arm Rest
54500-54599	545A00-545A99	Open	67200-67299	672A00-672A99	Rear Seat Silencer
54600-54699	546A00-546A99	Top Folding Compt.	67300-67399	673A00-673A99	Rear Seat Heelboard
54700-54799	547A00-547A99	Roof Weatherstrip	67400-67599	674A00-675A99	
54800-54899	548A00-548A99	Top Hold Down Strap			

IMPORTANT: AS EACH INDIVIDUAL EXPANSION SERIES BECOMES EXHAUSTED OF NUMBERS, ANOTHER SERIES WILL BE ESTABLISHED BY USE OF THE NEXT ALPHABETICAL EXPANSION LETTER SUCH AS "B" THRU "Z".

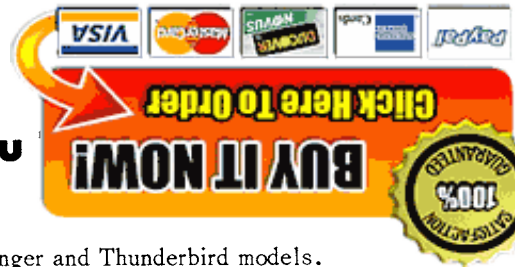

TYPICAL PATENT PLATE - thru

The Patent Plate is located on the left front body pillar on all passenger and Thunderbird models.

The following diagram of the Patent Plate specifies, in the Serial Number: the Engine Type, Model Year, Plant which assembled the car, Body Style and numerical sequence of assembly.

Indicated in the body specifications are the Body Type, Exterior Paint Color, Trim Scheme, Production Date, Transmission Type and Rear Axle Ratio.

IMPORTANT Always furnish appropriate Patent Plate information and DSO number if applicable when ordering parts not listed in the Catalog.

PATENT PLATE DIAGRAM

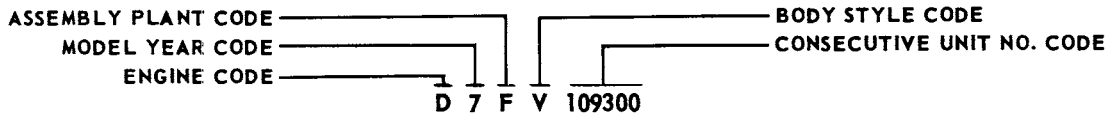

Serial Number (D7FV109300)

"D" -- 8 cyl. OHV Engine -- 312 cu. in. disp. -- 4-venturi carb.

"7" -- 1957 Model

"F" -- Assembled at Dearborn Plant

"V" -- Victoria body style -- Fairlane or Fairlane "500"

"109300" -- Nine thousand, three hundredth car assembled.

SERIAL	NUMBER	MADE IN				REG. U. S.
D7FV	109300	U.S.A. BY				PAT. OFF.
BODY	COLOR	TRIM	DATE	TRANS	AXLE	
63B	CE	H-1	17K	3	1	

THIS VEHICLE IS CONSTRUCTED UNDER UNITED STATES LETTER PATENTS

2 270 122	2 590 719	2 628 833	2 677 572	2 708 594
2 290 927	2 612 829	2 631 894	2 677 574	2 726 894
2 310 416	2 617 681	2 639 938	2 698 012	

OTHER PATENTS PENDING

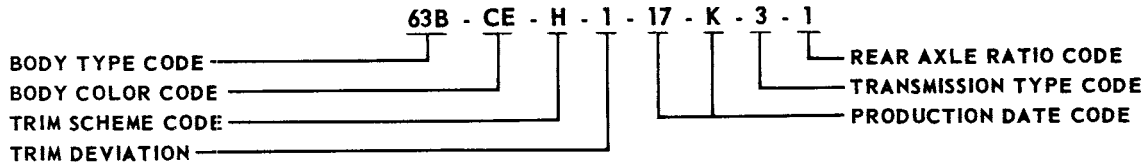

Style and Body Specifications (63B - CE - H - 1 - 17K - 3 - 1)

"63B" -- Victoria -- Fairlane Tudor

* "CE" -- Dresden Blue lower body, Colonial White upper body

"H" -- Colonial Vinyl and Blue Tropical-Leaf Fabric Bodycloth

"1" -- First Trim Deviation

"17" -- Seventeenth Day of Month

"K" -- Month of year -- October

"3" -- Fordomatic Transmission

"1" -- Rear Axle Ratio of 3.10 to 1.

* When vehicle is two-toned the lower body color code will appear first in the Paint Color Code space.

FORD CAR PARTS



PATENT PLATE - CONTINUE

REAR AXLE RATIO CODES					
REAR AXLE RATIO	REGULAR 1955/59	LOCKING DIFF. 1959	REAR AXLE RATIO	REGULAR 1955/59	LOCKING DIFF. 1959
2.69 to 1	6	F	3.70 to 1	3	C
2.91 to 1	5	F	3.89 to 1	4	D
3.10 to 1	1	A	4.11 to 1	0	
3.56 to 1	2	B			

MODEL YEAR CODES							
CODE	YEAR	CODE	YEAR	CODE	YEAR	CODE	YEAR
3	1953	5	1955	7	1957	9	1959
4	1954	6	1956	8	1958		

ASSEMBLY PLANT CODES					
CODE	ASSEMBLY PLANT	CODE	ASSEMBLY PLANT	CODE	ASSEMBLY PLANT
A	Atlanta	G	Chicago	M	Memphis
C	Chester	H	Lorain	N	Norfolk
D	Dallas	J	Los Angeles	P	Twin Cities
E	Mahwah	K	Kansas City	R	San Jose
F	Dearborn	L	Long Beach	S	Pilot Plant
				T	Metuchen
				U	Louisville
				W	Wayne
				Y	Wixom
				Z	St. Louis

TRANSMISSION TYPE CODES			
CODE	TRANSMISSION	CODE	TRANSMISSION
1	3 Speed Manual Shift	C	Fordomatic (3-speed)
2	Overdrive	5	4 Speed Manual Shift
3	Fordomatic (2-speed)	6	Cruise-O-Matic
4	Cruise-O-Matic		(3-speed dual range)

MONTHS OF THE YEAR CODES								
MONTH	YEAR First Second		MONTH	YEAR First Second		MONTH	YEAR First Second	
January	A	N	May	E	S	September	J	W
February	B	P	June	F	T	October	K	X
March	C	Q	July	G	U	November	L	Y
April	D	R	August	H	V	December	M	Z

DISTRICT CODES

CODE	DISTRICT	CODE	DISTRICT	CODE	DISTRICT	CODE	DISTRICT	CODE	DISTRICT	CODE	DISTRICT
11	Boston	23	Philadelphia	34	Indianapolis	45	Davenport	62	Houston	74	Seattle
12	Buffalo	24	Jacksonville	35	Lansing	51	Denver	63	Memphis	81	Ford of Canada
13	New York	25	Richmond	36	Louisville	52	Des Moines	64	New Orleans	83	Government
14	Pittsburgh	26	Washington	41	Chicago	53	Kansas City	65	Oklahoma City	84	HOME OFFICE RESERVE
15	Newark	31	Cincinnati	42	Fargo	54	Omaha	71	Los Angeles	85	AMERICAN RED CROSS
21	Atlanta	32	Cleveland	43	Rockford	55	St. Louis	72	San Jose	89	TRANSPORTATION SERVICES
22	Charlotte	33	Detroit	44	Twin Cities	61	Dallas	73	Salt Lake City	90's	Export

ENGINE CODES and HORSEPOWER RATINGS

ENGINE Cyl.	C.I.D.	TYPE	1952/53		1954		1955		1956		1957		1958		1959	
			CODE	H.P.	CODE	H.P.	CODE	H.P.	CODE	H.P.	CODE	H.P.	CODE	H.P.	CODE	H.P.
6	215	OHV	A	101												
8	239	L-HEAD	P	110												
8	239	L-HEAD	B													
6	223	OHV			A	115	A	120	A	137	A	144				
8	239	OHV			U	130										
8	256	OHV			P	161										
8	272	OHV-2V, Carb. -Standard					U	162	U	173	B	190				
8	272	OHV-2V, Carb. -Automatic					U	162	U	176	B	190				
8	272	OHV-4V, Carb. -Automatic					M	182								
8	292	OHV-2V, Carb. -Standard									C	206				
8	292	OHV-2V, Carb. -Automatic									C	212				
8	292	OHV-4V, Carb. -Standard					P	193	M	200						
8	292	OHV-4V, Carb. -Automatic					P	198	M	202						
8	312	OHV-4V, Carb. -Standard							P	215	D	245				
8	312	OHV-4V, Carb. -Automatic							P	225	D	245				
8	312	OHV-4V, Carb. (Supercharger)									F	300				
8	312	OHV-8V, Carb. (Hi-Performance Special)									E	270				
8	312	OHV-8V, Carb. (Racing)									E	285				
6	223	OHV-1V.											A	145	A	145
8	292	OHV-2V, Carb. -Standard											C	205	C	200
8	292	OHV-2V, Carb. -Automatic											C	205		
8	332	OHV-2V, Carb.											B	240	B	225
8	332	OHV-4V, Carb. (Special)											G	265		
8	352	OHV-4V, Carb. (Power option)											H	300	H	300
8	361	OHV-4V, Carb. (Police)												303		
8	430	OHV-4V, Carb. -Automatic											J	375	J	375

BODY TYPE CODES



CODE		BODY TYPE	MODEL YEARS	CODE		BODY TYPE	MODEL YEARS
BODY TYPE	SERIES			BODY TYPE	SERIES		
FORD 1949 thru 1959							
51A		Fairlane "500" Hide-Away Hardtop	1957/58	71F		Station Wagon "Country Sedan" (6 passenger)	1959
51A		Galaxie Hide-Away Hardtop	1959	71G		Station Wagon "Country Squire" (9 passenger)	1959
54A		Galaxie Town Sedan	1959	71H		Fordor Ranch Wagon	1959
57A		Fairlane Fordor Victoria	1956	72A		Ford Club Coupe	1949
57A		Fairlane "500" Town Victoria	1957/59	72B		Ford Custom Club Coupe	1949
57B		Fairlane Town Victoria	1957/58	72B		Custom Deluxe Club Coupe	1950
58A		Fairlane Town Sedan	1957/59	72B		Custom Club Coupe	1951
58B		Fairlane "500" Town Sedan	1957/59	72B		Customline Club Coupe	1952/54
58E		Custom "300" Fordor Sedan	1959	72C		Ford Business Coupe	1949
59A		Mainline Ranch Wagon	1952/56	72C		Deluxe Business Coupe	1950/51
59A		Tudor Ranch Wagon	1957/58	72C		Mainline Business Coupe	1952/54
59B		Customline Ranch Wagon	1954/56	73A		Ford Fordor Sedan	1949
59B		Tudor Ranch Wagon "Del Rio"	1957/58	73A		Deluxe Fordor Sedan	1950/51
59C		Fairlane Ranch Wagon	1956	73A		Mainline Fordor Sedan	1952/56
59C		Tudor Ranch Wagon	1959	73A		Custom Fordor Sedan	1957
59D		Tudor Ranch Wagon "Country Sedan"	1959	73A		Custom "300" Fordor Sedan	1958
59E		Tudor Commercial Ranch Wagon "Courier"	1959	73A		Ford Custom Fordor Sedan	1949
60		Victoria	1950	73B		Custom Deluxe Fordor Sedan	1950
60B		Crestline Victoria	1952/54	73B		Custom Fordor Sedan	1951
60B		Fairlane Victoria	1955	73B		Customline Fordor Sedan	1952/56
60F		Crestline Skyliner	1954	73B		Custom "300" Fordor Sedan	1957
63A		Fairlane "500" Club Victoria	1957/59	73B		Custom "300" Fordor Sedan (optional Interior Trim)	1958
63B		Fairlane Club Victoria	1957/58	73C		Crestline Fordor Sedan	1954
64A		Fairlane Crown Victoria-Solid Top	1955/56	73C		Fairlane Town Sedan	1955/56
64A		Fairlane Club Sedan	1957/59	75A		Galaxie Town Victoria	1959
64B		Fairlane Crown Victoria-Transparent Top	1955/56	76B		Ford Custom Convertible Coupe	1949
64B		Fairlane "500" Club Sedan	1957/59	76B		Custom Deluxe Convertible Coupe	1950
64C		Fairlane Victoria	1956	76B		Custom Convertible Coupe	1951
64D		Customline Victoria	1956	76B		Crestline Convertible Coupe	1952/54
64F		Custom "300" Tudor Sedan	1959	76B		Fairlane Convertible Coupe	1955/56
64G		Custom "300" Business Tudor	1959	76B		Fairlane "500" Convertible Coupe	1957/58
64H		Galaxie Club Sedan	1959	76B		Galaxie Convertible Coupe (Sunliner)	1959
65A		Galaxie Club Victoria	1959	78A		Sedan Delivery	1952/58
66A		Ranchero	1957/59	79		Ford Custom Station Wagon	1949
66B		Ranchero	1957/58	79		Custom Deluxe Station Wagon	1950
66C		Ranchero	1959	79		Custom Station Wagon "Country Squire"	1950/51
70A		Ford Tudor Sedan	1949	79A		Fordor Ranch Wagon	1958
70A		Deluxe Tudor Sedan	1950/51	79B		Customline Station Wagon "Country Sedan"	1952/55
70A		Mainline Tudor Sedan	1952/56	79B		Customline Station Wagon "Country Sedan" (6 passenger)	1955
70A		Custom Tudor Sedan	1957	79B		Fairlane Station Wagon "Country Sedan" (8 passenger)	1955/56
70A		Custom "300" Tudor Sedan	1958	79C		Crestline Station Wagon "Country Squire"	1952/55
70B		Ford Custom Tudor Sedan	1949	79C		Fairlane Station Wagon "Country Squire" (8 passenger)	1955/56
70B		Custom Deluxe Tudor Sedan	1950	79D		Customline Station Wagon "Country Sedan" (6 passenger)	1956
70B		Custom Tudor Sedan	1951	79D		Station Wagon "Country Sedan" (6 passenger)	1957/58
70B		Customline Tudor Sedan	1952/56	79E		Station Wagon "Country Squire" (9 passenger)	1957/58
70B		Custom "300" Tudor Sedan	1957				
70B		Custom "300" Tudor Sedan (optional Interior Trim)	1958				
70C		Fairlane Club Sedan	1955/56				
70D		Mainline Business Tudor	1955/56				
70D		Custom Business Tudor	1957				
70D		Custom "300" Business Tudor	1958				
71E		Station Wagon "Country Sedan" (9 passenger)	1959				

THUNDERBIRD 1955/59

40		Thunderbird Convertible	1955/57	S(76A)		Thunderbird Convertible	1958
S(63A)		Thunderbird Hard Top	1958	S(76A)	J	Thunderbird Convertible	1959
S(63A)	H	Thunderbird Hard Top	1959				

**PATENT PLATE - CONTINUED
TRIM SCHEME CODES**

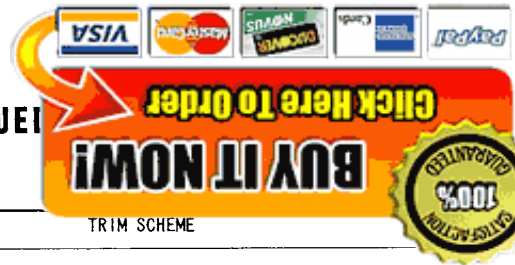

CODE	TRIM SCHEME	CODE	TRIM SCHEME
1957			
A	Silver and Gray Shantung Vinyl and Gray Random Block Fabric	AJ	Colonial Vinyl and Red Silver-Shadow Fabric
E	Starmist Chain-Grain Vinyl and Blue Silver-Dash or Blue Flying-Dart Fabric	AN	Willow Chain-Grain Vinyl and Green Flying-Dart or Green Silver-Dash Fabric
F	Woodsmoke Chain-Grain Vinyl and Gray Silver-Dash or Gray Flying-Dart Fabric	AR	Blue Basket-Weave Fabric and Blue Sculptured Fabric
G	Doeskin Chain-Grain Vinyl and Brown Silver-Dash Fabric	AS	Green Basket-Weave Fabric and Green Sculptured Fabric
H	Colonial Vinyl and Blue Tropical-Leaf or Blue Silver-Shadow Fabric	AT	Raven Vinyl and Gold Ripple-Wave Fabric
J	Colonial Vinyl and Green Tropical-Leaf or Green Silver-Shadow Fabric	AU	Colonial Vinyl and Flame Embossed or Pleated Flame Vinyl
K	Colonial Vinyl and Gray Tropical-Leaf Fabric	AX	Doeskin Vinyl and Tan Sharkskin Woven Plastic
L	Colonial Vinyl and Brown Tropical-Leaf or Brown Silver-Shadow Fabric	AZ	Colonial Vinyl and Tan Silver-Tweed Woven or Tan Silver-Tweed Puff Woven Plastic
R	Gray Basket-Weave Fabric and Gray Sculptured Fabric	BC	Blue Airweave Vinyl
S	Brown Basket-Weave Fabric and Brown Sculptured Fabric	BD	Green Airweave Vinyl
T	Gold Basket-Weave Fabric and Black Sculptured Fabric	BE	Black Airweave Vinyl
U	Colonial Vinyl and Black Silver-Shadow Fabric	BF	Red Airweave Vinyl
X	Colonial Vinyl and Blue Silver Tweed Woven or Blue Silver Tweed Puff Woven Plastic	BG	Brown Airweave Vinyl
AA	Colonial Vinyl and Raven Embossed Vinyl		
AB	Colonial Vinyl and Dresden Embossed or Blue French Stitch Vinyl		THUNDERBIRD
AC	Colonial Vinyl and Cumberland Embossed or Pleated Cumberland Vinyl	XA	Pleated Raven Vinyl and Pleated Colonial Vinyl
		XH	Pleated Flame Vinyl
		XJ	Pleated Bronze Vinyl
		XK	Pleated Colonial Vinyl
		XL	Pleated Dresden Vinyl and Pleated Starmist Vinyl
		XM	Pleated Cumberland Vinyl and Pleated Willow Vinyl

1958

A	Silver Shantung Vinyl and Silver Lattice-Pattern Fabric	Z	Colonial Sof-Textured Vinyl and Black Whipcord Embossed Vinyl
C	Blue Sof-Textured Vinyl and Blue Box-Striped Fabric or Blue Random-Block Patterned Fabric or Blue Royal Scot Tweed	AB	Beige Sof-Textured Vinyl and Shadow Pattern Woven Plastic
D	Green Sof-Textured Vinyl and Green Box Striped Fabric or Green Random-Block Patterned Fabric or Green Royal Scot Tweed	AC	Blue Sof-Textured Vinyl and Blue Basket Weave Plastic or Blue Thong Patterned Plasti-Fab
E	Gray Sof-Textured Vinyl and Gray Box-Striped Fabric or Gray Random-Block Patterned Fabric	AH	Beige Sof-Textured Vinyl and Brown Basket Weave Plastic or Brown Thong Patterned Plasti-Fab
F	Beige Sof-Textured Vinyl and Brown Random-Block Patterned Fabric or Brown Royal Scot Tweed	AJ	Gray Shadow-Block Patterned and Gray Damask Cloth
G	Colonial Sof-Textured Vinyl and Black Random-Block Patterned Fabric or Black Royal Scot Tweed	AK	Colonial Sof-Textured Vinyl and Gulfstream Royal Scot Tweed
H	Colonial Sof-Textured Vinyl and Palomino Royal Scot Tweed	AL	Colonial Sof-Textured Vinyl and Gulfstream Whipcord Embossed Vinyl
J	Blue Shadow-Block Patterned and Blue Damask Cloth	AM	Gold Sof-Textured Vinyl and Black Royal Scot Tweed
K	Green Shadow-Block Patterned and Green Damask Cloth	*CZ	Blue Sof-Textured Vinyl and Blue Random-Block Patterned Fabric
L	Brown Shadow-Block Patterned and Brown Damask Cloth	*DZ	Green Sof-Textured Vinyl and Green Random-Block Patterned Fabric
R	Black Shadow-Block Patterned and Gold Damask Cloth	*EZ	Gray Sof-Textured Vinyl and Gray Random-Block Patterned Fabric
S	Colonial Sof-Textured Vinyl and Red Royal Scot Tweed		THUNDERBIRD
U	Blue Sof-Textured Vinyl and Blue Whipcord Embossed Vinyl or Blue Embossed-Stitch Vinyl	XA	Blue Sof-Textured Vinyl and Blue Highland Tweed
V	Green Sof-Textured Vinyl and Green Whipcord Embossed Vinyl or Green Sof-Textured Vinyl	XB	Green Sof-Textured Vinyl and Green Highland Tweed
X	Colonial Sof-Textured Vinyl and Palomino Whipcord Embossed Vinyl	XC	Black Sof-Textured Vinyl and Black Highland Tweed
Y	Colonial Sof-Textured Vinyl and Red Whipcord Embossed Vinyl or Red Sof-Textured Vinyl	XE	Blue and White Sof-Textured Vinyl
		XF	Green and White Sof-Textured Vinyl
		XG	Red and White Sof-Textured Vinyl
		XH	Black and White Sof-Textured Vinyl
		XK	Gulfstream Sof-Textured Vinyl and Gulfstream Highland Tweed
		XL	Palomino and White Sof-Textured Vinyl
		XM	Gulfstream and White Sof-Textured Vinyl

* Used on Body Types 70B and 73B after May 9, 1958

FORD CAR PARTS

PATENT PLATE - CONTINUE TRIM SCHEME CODES

1959



CODE	TRIM SCHEME	CODE	TRIM SCHEME
02	Blue Ribbed Vinyl Bolster and Blue Random Block Fabric	57	Radiant Colonial White Sof-Textured Vinyl Bolster and TorchRed Striped Nub Fabric with Silver Strand
03	Green Ribbed Vinyl Bolster and Green Random Block Fabric	58	Radiant Colonial White Sof-Textured Vinyl Bolster and Torch Red Shantung Pattern Vinyl
07	Blue Tweedweave Fabric Bolster and Blue Linen-Pattern Cloth with Silver Fleck	59	Medium Blue Shantung Vinyl
08	Green Tweedweave Fabric Bolster and Green Linen-Pattern Cloth with Silver Fleck	60	Medium Brown Shantung Vinyl
09	Bronze Tweedweave Fabric Bolster and Bronze Linen-Pattern Cloth with Silver Fleck	024	Radiant Blue Sof-Textured Vinyl Bolster and Blue Shadowweave Fabric
10	Gray Tweedweave Fabric Bolster and Gray Linen-Pattern Cloth with Silver Fleck	032	Radiant Green Sof-Textured Vinyl Bolster and Green Shadowweave Fabric
11	Turquoise Tweedweave Fabric Bolster and Turquoise Linen-Pattern Cloth with Silver Fleck	111	Turquoise Tweedweave Fabric Bolster and Turquoise Linen-Pattern Cloth with Silver Fleck
12	Gray Tweedweave Fabric Bolster and Gold Linen-Pattern Cloth with Silver Fleck	121	Gray Tweedweave Fabric Bolster and Gold Linen-Pattern Cloth with Silver Fleck
25	Blue Sof-Textured Vinyl Bolster and Blue Lattice Pattern Plasti-Fab Weave	296	Radiant Silver Sof-Textured Vinyl Bolster and Gunsmoke Shadowweave Fabric
26	Fawn Sof-Textured Vinyl Bolster and Bamboo Pattern Vinyl	301	Blue Tweedweave Fabric Bolster and Blue Linen-Pattern Cloth with Silver Fleck
29	Gunsmoke Ribbed Vinyl Bolster and Gunsmoke Random Block Fabric	302	Radiant Blue Sof-Textured Vinyl Bolster and Blue Striped Nub Fabric with Silver Strand
30	Radiant Blue Sof-Textured Vinyl Bolster and Blue Shadowweave Fabric	311	Green Tweedweave Fabric Bolster and Green Linen-Pattern Cloth with Silver Fleck
30	Radiant Blue Sof-Textured Vinyl Bolster and Blue Striped Nub Fabric with Silver Strand	312	Radiant Green Sof-Textured Vinyl Bolster and Green Striped Nub Fabric with Silver Strand
31	Radiant Green Sof-Textured Vinyl Bolster and Green Shadowweave Fabric	323	Gray Tweedweave Fabric Bolster and Gray Linen-Pattern Cloth with Silver Fleck
31	Radiant Green Sof-Textured Vinyl Bolster and Green Striped Nub Fabric with Silver Strand	331	Bronze Tweedweave Fabric Bolster and Bronze Linen-Pattern Cloth with Silver Fleck
32	Radiant Silver Sof-Textured Vinyl Bolster and Gunsmoke Shadowweave Fabric	331	Radiant Bronze Sof-Textured Vinyl Bolster and Bronze Shadowweave Fabric
33	Radiant Bronze Sof-Textured Vinyl Bolster and Bronze Shadowweave Fabric	332	Radiant Bronze Sof-Textured Vinyl Bolster and Bronze Striped Nub Fabric with Silver Strand
33	Radiant Bronze Sof-Textured Vinyl Bolster and Bronze Striped Nub Fabric with Silver Strand	341	Radiant Turquoise Sof-Textured Vinyl Bolster and Turquoise Striped Nub Fabric with Silver Strand
34	Radiant Turquoise Sof-Textured Vinyl Bolster and Turquoise Striped Nub Fabric with Silver Strand	371	Radiant Colonial White Sof-Textured Vinyl Bolster and Geranium Striped Nub Fabric with Silver Strand
37	Radiant Colonial White Sof-Textured Vinyl Bolster and Geranium Striped Nub Fabric with Silver Strand	381	Radiant Gold Sof-Textured Vinyl Bolster and Raven Striped Nub Fabric with Silver Strand
38	Radiant Gold Sof-Textured Vinyl Bolster and Raven Striped Nub Fabric with Silver Strand	571	Radiant Colonial White Sof-Textured Vinyl Bolster and Torch Red Striped Nub Fabric with Silver Strand
39	Radiant Blue Sof-Textured Vinyl Bolster and Blue Shantung Pattern Vinyl	THUNDERBIRD	
40	Radiant Green Sof-Textured Vinyl Bolster and Green Shantung Pattern Vinyl	1X	Blue Sof-Textured Vinyl Bolster and Blue Nylon Check Fabric with Silver Strand
45	Radiant Green-Sof Textured Vinyl Bolster and Green Thong Pattern Plasti-Fab Weave with Gold Strand	2X	Green Sof-Textured Vinyl Bolster and Green Nylon Check Fabric with Silver Strand
46	Radiant Colonial White Sof-Textured Vinyl Bolster & Red Thong Pattern Plasti-Fab Weave with Gold Strand	3X	Turquoise Sof-Textured Vinyl Bolster and Turquoise Nylon Check Fabric with Silver Strand
47	Radiant Bronze Sof-Textured Vinyl Bolster and Bronze Shantung Pattern Vinyl	4X	Raven Sof-Textured Vinyl Bolster and Raven and White Nylon Check Fabric with Silver Strand
48	Radiant Geranium Sof-Textured Vinyl Bolster and Raven Striped Nub Fabric with Silver Strand	5X	Blue Sof-Textured Vinyl Bolster and Blue Sof-Textured Vinyl
49	Radiant Blue Sof-Textured Vinyl Bolster and Radiant Blue Pleated Sof-Textured Vinyl	6X	Green Sof-Textured Vinyl Bolster and Colonial White Sof-Textured Vinyl
51	Radiant Turquoise Sof-Textured Vinyl Bolster and Radiant Turquoise Pleated Sof-Textured Vinyl	7X	Turquoise Sof-Textured Vinyl Bolster and Colonial White Sof-Textured Vinyl
52	Radiant Gold Sof-Textured Vinyl Bolster and Raven Pleated Sof-Textured Vinyl	8X	Raven Sof-Textured Vinyl Bolster and Colonial White Sof-Textured Vinyl
53	Radiant Geranium Sof-Textured Vinyl Bolster and Raven Pleated Sof-Textured Vinyl	9X	Torch Red Sof-Textured Vinyl Bolster and Colonial White Sof-Textured Vinyl
55	Torch Red Sof-Textured Vinyl Bolster and Raven Pleated Sof-Textured Vinyl	1Y	Raven Genuine Top Grain Leather
56	Torch Red Sof-Textured Vinyl Bolster and Raven Striped Nub Fabric with Silver Strand	2Y	Hickory Tan Genuine Top Grain Leather
		3Y	Turquoise Genuine Top Grain Leather
		4Y	Torch Red Genuine Top Grain Leather
		5Y	Hickory Tan Sof-Textured Vinyl Bolster and Colonial White Sof-Textured Vinyl



PATENT PLATE - CONTINUE

EXTERIOR PAINT BODY COLOR CODES - Solid Colors

CODE	PART NUMBER	COLOR	CODE	PART NUMBER	COLOR
1952					
A	M-1724	Raven Black	J	M-14200	Hawaiian Bronze
B	M-14285	Sheridan Blue	K	M-2J-16	Sandpiper Tan
C	M-14448	Alpine Blue	L	M-2J-68	Sungate Ivory
D	M-2J-64	Woodsmoke Gray	M	M-1722	Coral Flame Red
E	M-2J-65	Shannon Green Metallic	N	M-14283	Meadow Green
F	M-2J-67	Meadowbrook Green	P		Prime
G	M-2J-66	Glenmist Green	SS		Special Paints
H	M-2J-43	Carnival Red			

1953					
A	M-1724	Raven Black	J	M-2J-188	Polynesian Bronze Metallic
B	M-14285	Sheridan Blue	K	M-2J-16	Sandpiper Tan
C	M-2J-184	Glacier Blue	L	M-2J-68	Sungate Ivory
D	M-2J-64	Woodsmoke Gray	M	M-2J-175	Coral Flame Red (Non-Bleeding)
E	M-2J-185	Timberline Green Metallic		M-1722	Coral Flame Red (Special)
F	M-2J-186	Fernmist Green	P	M-4415	Prime
G	M-2J-187	Seafoam Green	S	M-2J-221	Flamingo Red
H	M-2J-43	Carnival Red Metallic	SS		Special Paints

1954					
A	M-1724	Raven Black	J	M-2J-259	Lancer Maroon Metallic
B	M-14285	Sheridan Blue	L	M-2J-261	Sandalwood Tan
C	M-2J-253	Cadet Blue Metallic	M	M-2J-273	Sandstone White
D	M-2J-184	Glacier Blue	N	M-2J-175	Torch Red
E	M-2J-238	Dovetone Gray	R	M-2J-263	Cameo Coral
F	M-2J-256	Highland Green Metallic	P	M-4415	Prime
G	M-2J-257	Killarney Green Metallic	SS		Special Paints
H	M-2J-258	Sea Haze Green	V	M-2J-358	Golden Rod Yellow

1955					
A	M-1724	Raven Black	K	M-2J-357	Buckskin Brown
B	M-2J-346	Banner Blue	M	M-2J-353	Regency Purple
C	M-2J-347	Aquatone Blue	R	M-2J-175	Torch Red
D	M-2J-355	Waterfall Blue	T	M-2J-359	Thunderbird Blue (Skyhaze Green)
E	M-2J-354	Snowshoe White	V	M-2J-358	Goldenrod Yellow
F	M-2J-348	Pine Tree Green	W	M-2J-352	Tropical Rose
G	M-2J-349	Sea Sprite Green	P		Prime
H	M-2J-350	Neptune Green	S		Special

FORD CAR PARTS



Click Here To Order

BUY IT NOW!



PATENT PLATE - CONTINUE

EXTERIOR PAINT BODY COLOR CODES - So

CODE	PART NUMBER	COLOR	CODE	PART NUMBER	COLOR
1956					
A	M-1724	Raven Black	J	M-2J-528	Buckskin Tan
B	M-2J-521	Nocturne Blue	K	M-2J-530	Fiesta Red
C	M-2J-529	Bermuda Blue	L	M-2J-534	Peacock Blue
D	M-2J-523	Diamond Blue	M	M-2J-531	Goldenglow Yellow
E	M-2J-524	Colonial White	N	M-2J-533	Mandarin Orange
F	M-2J-525	Pine Ridge Green	P		Prime
G	M-2J-527	Meadowmist Green	S		Special
H	M-2J-532	Platinum Gray			

1957					
A	M-1724	Raven Black	P		Prime
C	M-1J-834	Dresden Blue	Q	M-1J-706	Thunderbird Bronze
E	M-2J-524	Colonial White	S		Special
F	M-1J-633	Starmist Blue	T	M-1J-756	Woodsmoke Gray
G	M-1J-755	Cumberland Green	V	M-1J-640	Flame Red
J	M-1J-747	Willow Green	X	M-1J-835	Dusk Rose
K	M-1J-841	Dark Brown (Special)	Y	M-1J-641	Inca Gold
L	M-1J-748	Doeskin Tan	Z	M-1J-642	Coral Sand
N	M-1J-757	Gunmetal Gray			
D	M-1J-871	Silver Mocha			

1958					
A	M-1724	Raven Black	M	M-1J-900	Gulfstream Blue
B	M-1J-495	Winterset White	N	M-1J-894	Seaspray Green
C	M-1J-896	Desert Beige	O	M-1J-979	Platinum
D	M-1J-902	Palomino Tan	P		Prime
E	M-2J-524	Colonial White	R	M-2J-175	Torch Red
F	M-1J-893	Silvertone Green	S		Special
G	M-1J-899	Sun Gold	T	M-1J-891	Silvertone Blue
H	M-1J-897	Gunmetal Gray	V	M-1J-859	Casino Cream
I	M-1J-1026	Grenadier Red	W	M-1J-860	Cameo Rose
J	M-1J-895	Bali Bronze	X	M-1J-857	Cascade Green
K	M-1J-856	Everglade Green	Y	M-1J-853	Monarch Blue
L	M-1J-892	Azure Blue	Z	M-1J-854	Regatta Blue

1959					
PASSENGER			THUNDERBIRD		
A	M-1J-1724	Raven Black	A	M-1J-1724	Raven Black
C	M-1J-1012	Wedgewood Blue	C	M-1J-1168	Baltic Blue
D	M-1J-1019	Indian Turquoise	D	M-1J-1019	Indian Turquoise
E	M-1J-524	Colonial White	E	M-1J-524	Colonial White
F	M-1J-1016	Fawn Tan	F	M-1J-1068	Hickory Tan
G	M-1J-1014	April Green	G	M-1J-1066	Glacier Green
H	M-1J-1015	Tahitian Bronze	H	M-1J-1015	Tahitian Bronze
J	M-1J-1011	Surf Blue	J	M-1J-1061	Steel Blue
Q	M-1J-1013	Sherwood Green	K	M-1J-1073	Sandstone
R	M-1J-175	Torch Red	L	M-1J-921	Diamond Blue
T	M-1J-1018	Geranium	M	M-1J-1067	Doeskin Beige
Y	M-1J-641	Inca Gold	N	M-1J-1167	Starlight Blue
Z	M-1J-1206	Gunsmoke Gray	Q	M-1J-1065	Sea Reef Green
P		Prime	R	M-1J-1216	Brandywine Red
S		Special	T	M-1J-1071	Flamingo
L	M-1J-1284	Surf Blue	U	M-1J-1172	Cordova
M	M-1J-1285	Sherwood Green	V	M-1J-859	Casino Cream
K	M-1J-1286	Tahitian Bronze	W	M-1J-1169	Tamarack Green
N	M-1J-1287	Gunsmoke Gray	Z	M-1J-979	Platinum
1	DL60-1232	Monte Carlo Red			
4	DL60-1273	Meadowvale Green			
5	DL60-1225	Belmont Blue			
6	DL60-1226	Skymist Blue			
W	DL60-1274	Adriatic Green			



Click Here To Order

BUY IT NOW!



APPEARANCE & MAINTENANCE MATERIALS

P&A PART NUMBER (ROTUNDA SALES NO.)	DESCRIPTION
B7A 19000-AS	Clear plastic (FoMoCo spray)-6oz. aerosol can 16 oz. can with brush
B7A 19000-BS	Chrome-alum.(FoMoCo spray)-6 oz.aerosol can
C1AZ 19000-A	Paint (Gloss Green-MX 6041168)-Enamel-air dry-1 gal. can
C1AZ 19000-B	Paint (Gloss Green-MX 6041168)-Enamel-air dry-5 gal. can
C1AZ 19000-C	Paint (Gloss Green-MX 6041168)-Enamel-55 gal. drum
C0AA 19A501-A	Solvent & penetrating fluid-manifold heat control valve-3 oz. can with plastic spout
C1AZ 19C502-A (R102-A)	Solution (metal tinning)-6 oz. Aerosol Spray can
C3AZ 19503-B	Paint assort. (30)-3 oz. cans of 1963 exterior colors including wire display stand
C3AZ 19503-C	Paint assort. (18)-6 oz. aerosol spray cans of 1963 exterior colors & (2) cans of primer surfacer-including wire display rack
C4AZ 19503-A	Paint Assort. (22)-1 qt. cans of 1964 exterior colors (2 qts.) recoating sealer (3 gals.) enamel reducer (2 gals.) non-sand primer surfacer, (1 gal.) Silicone & wax remover & (2 gal.) lacquer primer surfacer
C4AZ 19503-B	Paint assort. (30)-3 oz. cans of 1964 exterior colors including wire display rack
C4AZ 19503-C	Paint assort. (18)-6 oz. aerosol spray cans of 1964 exterior colors & (2) cans of primer surfacer-including wire display stand
C1AZ 19C507-A (R110-A)	Cleaner (Convertible rear window)-8 oz. plastic bottle
B9AE 19B508-A (R112-A)	Contact Adhesive - Gasket & Seal 16 oz. can with brush
8A 19510-A (R123-A)	Dye (Convertible top dressing)-qt. can (Black)
B9A 19514-A (R124-A)	Protector (chrome)-12 oz. Aerosol Spray can
AB 19515-A (R108-B)	Body undercoating-53 gallon drum (WATER EMULSION)
B5A 19515-A (R108-A)	Body undercoating-53 gallon drum (regular)
1A 19517 (R116-A)	Dusting cloth-wax treated-17 1/2" x 23"
8A 19517 (R116-B)	Rymplecloth-polishing-28" x 28"
8A 19519-A (R122-A)	Cleaner (body polish & wax)-1 pint can
B9LF 19B519-A (R125-A)	Refrigerant (Air Conditioner)-15 oz. can
B7A 19520-A (R126-A)	Tar & road oil remover-16 oz. can
8A 19520-G	Cleaner (body porcelainize)-1 gal. can
B7A 19521-A (R121-A)	Spot Remover (chlorothene cleaner)-1 pint can
C0AA 19B521-A (R127-A)	Compound (body washing detergent)-12 oz. can
C0AZ 19522-A	Cleaner (chrome)-12 oz. plastic bottle w/brush
8A 19522 (R120-A)	Cleaner-chrome-1 pint can
B7A 19523-A	Cleaner (Whitewall tire)-13 oz. plastic bottle
B8A 19523-A (R119-B)	Cleaner (Whitewall tire)-1 qt. can liquid concentrate
B8A 19523-B (R119-A)	Cleaner (all purpose)-1 gal. plastic bottle
B8A 19524-A (R61-A)	Sprayer Self Energizing - 1 quart
C3RZ 19524-A (R61-B)	Spray applicator (1-pint container)-for use with B8A 19523-B all purpose cleaner
B5A 19525-A	Kar Klean (all purpose trim cleaner)-28 oz. can
C2AZ 19C525-A (R114-A)	Trim cement (Vinyl adhesive)-1 pint can

P&A PART NUMBER (ROTUNDA SALES NO.)	DESCRIPTION
C0AZ 19526-A (R118-A)	Interior fabric & fabric upholsterys-12 oz. bottle with brush
C0AZ 19526-B (R118-B)	Deep clean-upholstery foam cleaner-32 oz. plastic bottle
B7A 19528-A	Porcelainize liquid-6 oz. bottles
8A 19529-B	Porcelainize (wash cream)-8 oz. bottle
B6A 19530-A (R111-B)	Custom body polish-12 oz. plastic bottles
B7A 19530-A (R111-A)	Silicone body polish-16 oz. can
B7A 19530-B (R111-C)	Custom Silicone Gloss (New Car Prep)-1 gal.
B9A 19530-D (R111-D)	Custom auto polish - 4 -1 Gal. plastic bottle
B4A 19534-A (R128-B)	Custom auto wax-8 oz. can
B8A 19534-A (R128-A)	Custom auto wax - 1 lb. can
B7A 19542-B (R103-B)	Brake & hydraulic clutch fluid (heavy duty)-1 gallon
B7A 19542-C (R103-C)	Brake & hydraulic clutch fluid (heavy duty)-5 gallon
B7AZ 19542-A (R103-A)	Brake & hydraulic clutch fluid (heavy duty)-12 oz. can
C3RZ 19C543-A (R140-A)	Tire inflator & Sealant kit
B7A 19544-A (R100-A)	Anti-freeze (Methanol)-55 gal. drum
1A 19544-A (R100-B)	Anti-freeze (Methanol)-1 gal. can
1A 19544-C (R100-C)	Anti-freeze (Methanol)-1 quart can
C3RZ 19C544-A (R142-A)	De-Icer (windshield)-14 oz. Aerosol can
8A 19546-C (R104-A)	Radiator rust inhibitor & water pump lubricant-16 oz.
C1AA 19B546-A	Lubricant (Hypoid additive)-4 oz. plastic bottle
TAAAX 19547-A	Fire extinguisher fluid-1 quart
C3RZ 19C547-B	Lubricant (std., 3 & 4 speed trans.)-5 gal.
C2RZ 19C548-A (R141-A)	Power steering & automatic trans. additive-8 oz. can
C2AZ 19549-C (R 100-F)	Anti-Freeze (permanent type-long life)-55 gal. drum
8A 19549-A (R100-D)	Anti-freeze-permanent type-1 gallon-(Ethylene Glycol)
8A 19549-B (R100-E)	Anti-freeze-permanent type-1 quart-(Ethylene Glycol)
CPA 19550-A (R109-B)	W/shield washer solvent-6 oz. bottle
C1AA 19550-A (R109-A)	W/shield washer solvent-16 oz. can
8A 19552-B (R133-A)	Rubber cement-5 oz. tube
C0AZ 19552-A	Rubber cement-5 oz. tube (light colored)
C0AZ 19553-A (R113-A)	Silicone lubricant (jell type)-8 oz. tube
C0AZ 19553-C (R113-C)	Silicone lubricant-16 oz. aerosol spray can
B5A 19554-A (R134-B)	Perfect seal sealing compound- ^{CARTON OF 12} 4 OZ. CANS
C0AA 19554-A (R104-B)	Radiator inhibitor-rust, stop leak & water pump lubricant-5 1/2 oz. bottle
8A 19554-B (R134-A)	Perfect seal sealing compound-1 pint
C3AZ 19554-B	Sealer (conductive)-3 oz. can with brush
B6A 19555-A	Reactivator-brake lining bonding adhesive-1 qt.
B6A 19558-A (R105-A)	Protector pellet (cooling system)- ^{12 PELLETS}
C0AZ 19558-A (R105-B)	Protector pellet (cooling system)-1 ctn. containing 300 pellets individually wrapped

◇ Available to New York City Dealers only

FORD CAR PARTS



APPEARANCE & MAINTENANCE MAT

P&A PART NUMBER (ROTUNDA SALES NO.)	DESCRIPTION	P&A PART NUMBER (ROTUNDA SALES NO.)	DESCRIPTION
AB 19560-A (R135-A)	Calking cord-6-80 foot rolls - 3/16" dia.	C2AZ 19580-D	Hypoid gear lubricant (rear axle)-1 gal. (8 cyl. 406)
B6A 19562-A	Body caulk & sealer kit	C2AZ 19580-E	Lubricant (differential gears & washer)-1 lb. can-apply to differential case side, gear hub bores before assembly
C3AZ 19562-A (R144-A)	Sealer & filler (silicone rubber)-5 oz. tube-for Vinyl tops, also body sealer-White	B5A 19581-A (R136-A)	Speedometer cable grease-1 lb. can
C3AZ 19562-B (R144-B)	Sealer & filler (silicone rubber)-5 oz. tube-for Vinyl tops, also body sealer-Black	C1AZ 19582-A (R106-A)	Fluid (Automatic Trans. & Power Steering)- 1 qt. can
ΔB6A 19563-A	Caulk & sealer (Metallic)-7 1/2 oz. cartridge	C1AZ 19582-C (R106-B)	Fluid (Automatic Trans. & Power Steering)- 1 gal. can
C3AZ 19578-A	Steering gear lubricant (life time)-14 1/2 oz. tube	C1AZ 19582-D (R106-C)	Fluid (Automatic Trans. & Power Steering)- 55 gal. drum
B8A 19578-A	Special steering gear lubricant-20 oz. tube	B6A 19583-A (R137-A)	Ru-Glyde lubricant(for tubeless tire servicing)- 1-gal. can
B7A 19579-A (R115-A)	Carb. & combustion chamber cleaner-16 oz. can	C0AZ 19584-A (R138-A)	Lubriplate (all purpose lubricant) 1 3/4 oz. tube
B7A 19579-C (R146-A)	Crankcase conditioner & rust inhibitor-16oz. can	C2AZ 19585-A	Grease (wheel bearing) 25 lb. pail - (30,000 mile lubricant)
*B9A 19579-A	Carb. & combustion chamber cleaner kit	C1AZ 19586-B	Lubricant ("U" joint)-14 1/2 oz. cartridge
C2AZ 19579-A (R107-A)	Crankcase oil conditioner-16 oz. can	B4A 19587-A (R117-A)	Lock lubricant-carton of 12-4 oz. cans
C1AZ 19580-E	Hypoid gear lubricant (rear axle)-1 gal. (S. A. E. 90)	B7A 19588-A	Anti-sludge oil additive-30 gal. drum
C1AZ 19580-F	Hypoid gear lubricant (rear axle)-110 lb. keg (S. A. E. 90)	B8A 19589-A	Lubricant (special purpose) 1 lb.
C2AZ 19580-A	Hypoid gear lubricant (rear axle)-110 lb. keg (S. A. E. 90)	C1AZ 19590-B	Grease (ball joint & tie rod lubricant)-14 1/2 oz. container
C2AZ 19580-B	Hypoid gear lubricant (rear axle)-5 gal. container-S.A.E.80 (temperature range-minus 25° and below)		

USED CAR RECONDITIONING MATERIALS

P&A PART NUMBER (ROTUNDA SALES NO.)	DESCRIPTION	P&A PART NUMBER (ROTUNDA SALES NO.)	DESCRIPTION
C0AA 19A536-A (R129-A)	Engine Shampoo (cleaner & degreaser) 5 gal. can	C0AB 19B544-A (R132-A)	Kit-Bright Metal Reconditioning - Consists of 1 pt. Bright Metal Base Coating 1-4 oz. can Bright Metal Powder 1 pt. Bright Metal Sealer Coating 1 piece 3 1/2" x 6" Lamb's Wool 1 Spray Pak Device Including Nozzle 1 Glass Reservoir & (2) 15 oz. Paint Spray Propellant with Delivery Tube 1 Extra Delivery Tube 4- 12" x 16" Paper Cloth Cleaners 1 Instruction Sheet - No. I. S. 539
C0AZ 19A536-B (R129-B)	Engine shampoo (cleaner & degreaser) 30 gal. drum	C0AB 19A547-A (R101-A)	Filler (Polyfiller)-body repair-3 lb. can & tube of cream hardener C0AZ 19B542-A
C0AZ 19A536-C (R129-C)	Engine Shampoo (cleaner & degreaser) 55 gal. drum		
B9AA 19537-A (R130-A)	Patch (Rubber Mat)-1 pkg. of 6		
C0AB 19B542-A (R101-B)	Cream (poly filler hardener)-1 pkg. of 5- 1 oz. tubes		
C1AZ 19627-A	Tape (pressure sensitized)-5" wide x 60 yards- used to recover arm rests, seats, floor mats, etc.		

PART NUMBER	DESCRIPTION	PART NUMBER	DESCRIPTION	PART NUMBER (ROTUNDA SALES NO.)	DESCRIPTION	PART NUMBER (ROTUNDA SALES NO.)	DESCRIPTION
NYLON DYE - QUART CAN				PLASTIC DYE - QUART CAN			
B9AA 19A538-A	Black	B9AA 19A538-E	Green	B9AA 19A541-A	White	B9AA 19A541-E	Gray
B9AA 19A538-B	White	B9AA 19A538-F	Yellow	B9AA 19A541-B	Black	B9AA 19A541-F	Blue
B9AA 19A538-C	Brown	B9AA 19A538-G	Red	B9AA 19A541-C	Brown	B9AA 19A541-G	Turquoise
B9AA 19A538-D	Blue			B9AA 19A541-D	Green	B9AA 19A541-H	Red
PLASTIC TINT - QUART CAN				FABRIC TINT - QUART CAN			
B9AA 19A539-A	White	B9AA 19A539-E	Green	B9AA 19A542-A (R131-A)	Black	B9AA 19A542-F (R131-F)	Green
B9AA 19A539-B	Black	B9AA 19A539-F	Yellow	B9AA 19A542-B (R131-B)	Blue	B9AA 19A542-G (R131-G)	Turquoise
B9AA 19A539-C	Brown	B9AA 19A539-G	Red	B9AA 19A542-C (R131-C)	Gray	B9AA 19A542-H (R131-H)	Beige
B9AA 19A539-D	Blue			B9AA 19A542-D (R131-D)	Brown	B9AA 19A542-J (R131-J)	Yellow
LEATHER and VINYL DYE - QUART CAN				B9AA 19A542-E (R131-E)	Red		
B9AA 19A540-A	White	B9AA 19A540-E	Green				
B9AA 19A540-B	Black	B9AA 19A540-F	Yellow				
B9AA 19A540-C	Brown	B9AA 19A540-G	Red				
B9AA 19A540-D	Blue	B9AA 19A540-H	Turquoise				

Δ Use with B6A 19562-A body caulk and sealer kit

* 24 - 16 oz. cans of B7A 19579-A and (1) Plastic dispenser bottle

ABBREVIATIONS



2/b or 2/v..... 2 barrel
 3/T..... 3 speed trans.
 4/b or 4/v..... 4 barrel
 4/T or 4/S/T..... 4 speed trans.
 6/b or 6/V..... 6 barrel
 abs..... absorber
 A/C..... air conditioner
 altnr..... alternating
 accel..... accelerator
 adj..... adjustment
 alum..... aluminum
 amp..... ampere
 approx..... approximately
 AR..... As Required
 assy..... assembly
 A/S..... air suspension
 attach..... attached

blk..... block
 brg..... bearing
 brkt..... bracket
 brkr..... breaker
 bus..... business

carb..... carburetor
 C/CW..... counter clockwise
 C. I. D..... cubic inch displacement
 C/L..... Customline
 C/M..... cruise-o-matic
 C. P..... candle power
 clstr..... cluster
 c/member..... crossmember
 col..... column
 com..... compressor
 compt..... compartment
 cond..... conditioning
 conn..... connecting
 con..... control
 cvr..... cover
 cov..... cover
 cp..... candle power
 c/pin..... cotter pin
 c/shaft..... crankshaft
 ctr..... center
 C/W..... clockwise
 cyl..... cylinder

def..... defroster
 defl..... deflector
 dia..... diameter
 diam..... diameter
 diff..... differential
 disp..... displacement
 dist..... distributor

elec..... electric
 eng..... engine
 equal..... equalizer

exh..... exhaust
 ext..... external

fdr..... fender
 fill..... fillister
 frt..... front
 F/L..... Fairlane
 flr..... floor
 F/M..... Fordomatic
 F/M/2..... Fordomatic 2 speed
 ft..... foot
 f/wheel..... flywheel
 flex..... flexible

gen..... generator
 gov..... governor

H/D..... heavy duty
 hd..... head
 hex..... hexagon
 HP..... horsepower
 htr..... heater
 hsg..... housing
 hyd..... hydraulic

I. D..... inside diameter
 identi..... identification
 indic..... indicator
 int..... internal
 ign..... ignition
 instru..... instrument
 inter..... intermediate

lb..... pound
 L. H..... left hand
 lt./frame..... light weight frame
 lub..... lubricator
 l/w..... lockwasher
 l/washer..... lockwasher
 lwr..... lower

man..... manifold
 med..... medium
 M/L..... Mainline
 mldg..... moulding
 mtd..... mounted
 mtg..... mounting
 mtr..... motor

No..... number

o/all..... overall
 O. D..... outside diameter
 O/D..... overdrive
 o/drive..... overdrive
 O. H. V..... over head valve
 o/s..... oversize
 oz..... ounce

pa.....
 pc.....
 P/L..... Police intercom
 P/L..... Park
 press..... pressure
 P/S..... power steering
 pt..... pint

qtr..... quarter
 qty..... quantity

rad..... radiator
 rd..... round
 reg..... regulator
 reinf..... reinforcement
 repl..... replaced
 ret..... retainer

R. H..... right hand
 R. P. M..... revolutions per minute

S/C..... Supercharger
 S/D..... Sedan Delivery
 S/L..... Sunliner

speedo..... speedometer
 sprg..... spring
 s/ring..... snap ring
 std..... standard
 strg..... steering

S/T..... standard transmission
 suppt..... support
 susp..... suspension
 S/W..... Station Wagon

tach..... tachometer
 temp..... temperature
 thd..... thread
 trans..... transmission
 T. V..... throttle valve

u/joint..... universal joint
 u/s..... undersize

vac..... vacuum
 vent..... ventilation

w/..... with
 w/o..... without
 w/s..... windshield

w/shield..... windshield
 w/strip..... weather strip
 warn..... warning
 wt..... weight

x/c..... extra cooling

FORD CAR PARTS



MOULDING CLIP KIT

NOTE - Each Kit Contains Sufficient Clips Etc. For Att

Click Here To Order
BUY IT NOW!



Year	Model Or Body Type	Part Number of Moulding Used With	Components of Kit				NO.
55/56	S	B5S 8156-A	8-43804-S8	Screw & Washer			† B5S 100-A
			8-44716-S8	Washer			
53	A	B3A 8242-3-A	4-34053-S8	Nut	3-44716-S8	Washer	† B3A 101-A
			1-FAA 13241-A	Spacer	4-34903-S8	Washer	
54	A	B4A 8242-B	10-B4A 8244-A	Retainer	2-352356-S32	Clip	B4A 101-A
55	60B, 64, 76	B5A 16856-A					
55/56	S	B5S 8242-3-B	3-52360-S13	Screw	3-354515-S2	Nut	† B5S 101-A
55/56	S	B5S 8419-A	6-34053-S8	Nut	6-351316-S8	Washer	B5S 102-A
			6-34803-S7	Washer	6-358566-S100	Clip	
56/57	57A,59C,64A,64B,64C,70C,73C,76	B6A 13011-A	1-41580-S8	Screw	1-354933-S32	Clip	† B6A 105-A
52/53	60B,70B,72B,73B,76B,79B	BA 16003-B	1-357118-S8	Clip	1-358484-S8	Clip	B2A 110-A
			3-358398-S8	Clip	Replaced by B2A 207-A		
54	59B,60B,60F,70B,72B,73B,76B,79B	BM 16003-4-B	1-34053-S8	Nut	5-BM 7021020-B	Retainer	B4A 110-A
			1-44716-S8	Washer	1-BM 7029120-A	Retainer	
55/57	59B,70A,73B,79B,79D	B5A 16003-A	1-34053-S8	Nut	5-358484-S8	Clip	★ B5A 110-A
			1-34903-S8	Washer	1-358566-S100	Clip	
					Replaced by B5A 305-A		
56	59B,64D,70B,73B,79D	B6A 16003-4-A	2-354397-S100	Nut & washer	2-B6A 7029120-B	Retainer	B6A 110-A
			3-B6A 7021066-C	Retainer			
57	51A,57A,58B,59B,63A,64B,66B,70B,73B,76B,79C,79D	B7A 16003-4-B	1-354397-S100	Nut & washer	1-B7A 7029120-A	Retainer	B7A 110-A
			6-B6A 7021066-C	Chip			
58	59,66,70,73,78,79	B8A 16003-4-A	1-52726-S13	Screw	2-B8A 5728506-A	Retainer	B8A 110-A
	57B,58A,63B,64A	B8A 16036-7-A	2-354397-S100	Nut & washer	6-B8A 7021094-A	Retainer	
59	51A,54A,57A,58A,58B,59D,63A,64A,64B,64H,65A,71E,71F,75A,76B	B9A 16036-7-A	1-354397-S100	Nut & washer	5-B9AB 6420262-A	Retainer	B9A 110-A
		B9A 5820932-3	2-354613-S8	Screw	2-B9A 6421082-A	Retainer	
		B9A 6320932-3	1-B8A 5728506-A	Retainer			
56	57A,59C,64A,64B,64C,70C,73C,76B,79B	B6A 16003-4-B	5-354397-S100	Nut & washer	2-B5A 7021094-A	Retainer	B6A 111-A
			1-BJ 16249-B	Retainer	1-B6A 7021094-A	Retainer	
			1-B6A 16249-A	Retainer			
58	57B,58A,63B,64A	B8A 16003-4-D	1-354397-S100	Nut & washer	1-B8A 7028506-A	Retainer	† B8A 111-A
			1-B8A 7021094-A	Retainer			
59	51A,54A,57A,58A,58B,59D,63A,64A,64B,64H,65A,71E,71F,75A,76B	B9A 16003-4-B	1-354397-S100	Nut & washer	1-B9A 5829120-B	Retainer	B9A 111-A
		B9A 5720938-9-B	2-354613-S8	Screw	6-B9A 6421094-A	Retainer	
		B9A 6420938-9-B	2-B9A 5821094-A	Retainer			
58	51A,57A,58B,63A,64B,76	B8A 16003-4-C	6-B8A 16249-A	Retainer	2-354397-S100	Nut & washer	B8A 112-A
			2-B7A 5929120-A	Retainer			
59	59C,58E,64F,64G,66C,71H	B9A 16003-4-A	3-B9A 6421066-A	Retainer	2-B9A 5821066-A	Retainer	B9A 112-A
			1-B9A 6421020-A	Retainer	3-354397-S100	Nut & washer	
57	59B,66B,70B,73B,79C,79D	B7A 16036-7-A	2-354397-S100	Nut & washer	7-B7A 16794-A	Retainer	B7A 115-A
57	51A,57A,58B,63A,64B,76B,79C,79D	B7A 16036-7-B	2-354397-S100	Nut & washer	7-B7A 16794-B	Retainer	B7A 116-A
57	A	B7A 16074-A			Replaced by B7A 117-B		★ B7A 117-A
			2-45235-S7	Nut	2-B7A 16086-A	Retainer	
57	A	B7A 16074-5-A	1-B7A 16086-A	Retainer	4-45235-S7	Nut	B7A 117-B
			1-B7A 16087-A	Retainer			
52	60B,70B,72B,73B,76B,79B	BA 16188-9-A	2-34053-S7	Nut	1-358400-S8	Clip	B2A 118-A
			1-358399-S8	Clip			
53	60B,70B,72B,73B,76B,79B	BF 16188-9-A & B	2-34053-S8	Nut	1-358548-S8	Clip	† B3A 118-A
			1-358545-S8	Clip			
57	A	B7A 16075-A	2-45235-S7	Nut	2-B7A 16087-A	Retainer	★ B7A 118-A
					Replaced by B7A 117-B		

† No Longer Supplied Service Details



MOULDING CLIP KITS

NOTE - Each Kit Contains Sufficient Clips Etc. For Attaching

Click Here To Order

BUY IT NOW!



Year	Model or Body Type	Part Number of Moulding Used With	Components of Kit				Number
55	60B,64A,64B,70C,73C,76B,79B,79D	B5A 16326-7-A	1-52711-S13 10-354397-S100 1-358566-S100	Screw Nut & washer Clip	3-B5A 16249-A 1-B5A 16276-A 5-B5A 7021094-A	Retainer Retainer Retainer	B5A 119-A
55/56	64	B5A 6403136-7-A	2-34053-S8 2-34803-S7 2-44716-S8	Nut Washer Washer	3-52003-S13 2-B5A 6403166-A	Screw Retainer	B5A 130-A
55/56	64	B5A 6403144-A	8-34053-S8 8-34903-S8	Nut Washer	8-44716-S8 8-B5A 6403166-A	Washer Retainer	B5A 131-A
55/57	S	B5S 4003144-A	6-32914-S8	Screw	8-B6S 4005180-A	Clip	B5S 131-A
57	51A 76B	B7A 5103144-A B7A 7603144-A	3-52368-S23	Screw	2-52720-S8	Screw	B7A 131-A
55/56	76B	B5A 7603144-A	4-41580-S8	Screw	4-52003-S13	Screw	B5A 132-A
55	60B,64,70C,73C,76,79B	B5A 7020916-7-A	2-34053-S8 2-34903-S8 2-44716-S8 1-354793-S7	Nut Washer Washer Screw & washer	1-B5A 7021066-D 1-B5A 7021066-E 1-B5A 7021094-B 1-B5A 7021094-C	Retainer Retainer Retainer Retainer	B5A 200-A
57	51A	B7A 5120916-7-A	1-37611-S7 1-B7A 6421066-B	Screw Retainer	6-B6A 7021066-C	Retainer	B7A 200-A
58	51A,57A,58B,63A,64B,76B	B8A 6420442-A	1-37611-S7	Screw	1-B8A 7325553-A	Retainer	B8A 200-A
57	63A,64B,76B	B7A 6420916-7-A	1-37611-S7 2-354397-S100 1-B7A 6421066-B	Screw Nut & washer Retainer	4-B6A 7021066-C 2-B7A 7029120-A	Retainer Retainer	B7A 201-A
57	63A,64B,76B	B7A 6420916-7-A	2-37611-S7 2-354397-S100 2-B7A 6421066-B	Screw Nut & washer Retainer	4-B9AB 6429144-A 2-B7A 7029120-A	Retainer Retainer	B7A 201-B
57	57A,58B,59B,66B,70B	B7A 5720938-9-A B7A 7020916-7-A	2-37611-S7 1-354397-S100 2-B7A 6421066-B	Screw Nut & washer Retainer	4-B6A 7021066-C 1-B7A 7029129-A	Retainer Retainer	B7A 202-A
57	73B,79C,79D	B7A 7320916-7-A	2-37611-S7 2-B7A 6421066-B	Screw Retainer	4-B6A 7021066-C	Retainer	B7A 203-A
57	51A,63,64B,76B	B7A 5120932-3-A B7A 6420932-3-A	1-37611-S7 1-354397-S100 1-358566-S100	Screw Nut & washer Clip	6-B7A 5820232-A 1-B7A 7021066-B 6-B7A 7350992-A	Retainer Retainer Retainer	B7A 204-A
58	57B,58A,57A,58B,63B,64A,51A,63A,64B,76B,57B,58A,57A,58B,63B,64A,51A,63A,64B,76B,59,66,70,78,73,79C,79D,57A,58B	B8A 5720932-3-A B8A 5720932-3-B B8A 6420932-3-A B8A 6420932-3-B B8A 5720938-9-A B8A 5720938-9-B B8A 6420938-9-A B8A 6420938-9-B B8A 7020938-9-A B8A 7320938-9-A B8A 5725540-1-A	2-37611-S7 2-B7A 6421066-B	Screw Retainer	5-B8A 7021094-A	Retainer	B8A 204-A
59	58A,58E,59C,64A,64F,64G,66C,71E,71F,71H	B9A 5720938-9-A B9A 6320938-9-A	2-354613-S8 4-6421066-A	Screw Retainer	2-B9A 6428820-A	Retainer	B9A 204-A
57	57A,58B	B7A 5820932-3-A	1-37611-S7 5-B7A 5820232-A	Screw Retainer	Replaced by B7A 204-A 1-B7A 7021066-B 5-B7A 7350992-A	Retainer Retainer	B7A 205-A
58	59B,66B,70	B8A 7021188-A	4-358566-S100	Retainer	1-BM 7029120-A	Retainer	B8A 205-A
					Replaced by B8A 206-A		

† No Longer Supplied Service Details

FORD CAR PARTS MO



MOULDING CLIP KITS

NOTE - Each Kit Contains Sufficient Clips Etc. For Attaching

Click Here To Order

BUY IT NOW!



Year	Model or Body Type	Part Number of Moulding Used With	Components of				
55	59B,70B,70C	B6A 5920934-5-A	2-39016-S7	Screw	2-B5A 7021060-B	Retainer	B6A 206-A
	73B,73C,79	B6A 7920934-5-A	2-B5A 7021060-A	Retainer			
55/56	59C,78	B6A 5920934-5-A					
56	79	B6A 7920934-5-A					
57	59B,70B	B7A 7020932-3-A	2-37611-S7	Screw	2-B7A 7021066-E	Retainer	B7A 206-A
	73B,79C,79D	B7A 7320932-3-A	5-B7A 7020232-A	Retainer	5-B7A 7350992-A	Retainer	
58	73, 79C, 79D	B8A 7321188-A	2-37611-S7	Screw	2-B7A 7021066-E	Retainer	B8A 206-A
			5-354397-S100	Nut & washer	1-BM 7029120-A	Retainer	
			4-358566-S100	Retainer			
52/53	60B,70B,72B,73B, 76,79 B	BA 7020938-B	2-34053-S8	Nut	4-358398-S8	Clip	B2A 207-A
			2-357118-S8	Clip	1-358484-S8	Clip	
56	57	B6A 5720938-9-A	2-34053-S8	Nut	1-B6A 7021094-C	Retainer	B6A 207-A
	59C,64A,64B,64C, 70C,76	B6A 7020938-9-A	4-354397-S100	Nut & washer	1-B6A 7021094-D	Retainer	
	73C,79B	B6A 7320938-9-A	1-B6A 7021094-A	Retainer	3-B6A 7021094-F	Retainer	
57	51A	B7A 5120938-9-A	1-37611-S7	Screw	1-354397-S100	Nut & washer	B7A 207-A
	63A,64B,76B	B7A 6420938-9-A					
58	57A, 58B	B8A 5724712-3-A	3-37611-S7	Screw	1-B7A 6421066-B	Retainer	B8A 207-A
			2-B8A 5725553-A	Retainer			
56	59B,64D,70B	B6A 7020938-9-A	2-34053-S8	Nut	2-B6A 7021094-G	Retainer	B6A 208-A
	73B,79D	B6A 7320938-9-A	2-B6A 7021066-C	Retainer			
52/54	73B,73C,79	BA 7324462-A	1-352230-S8	Clip	1-352246-S8	Clip	B2A 209-A
58	73	B8A 7324712-3-A	1-37611-S7	Screw	1-B7A 7021066-E	Retainer	B8A 209-A
	79C, 79D	B8A 7924712-3-A	3-354397-S100	Nut & washer	3-B8A 7028506-A	Retainer	
	73	B8A 7324722-3-A	3-358566-S100	Retainer			
	79C, 79D	B8A 7924722-3-A					
58	73A(Special), 79A	B8A 7325440-1-A	3-354397-S100	Nut & washer	2-B6A 7029120-C	Retainer	B8A 210-A
	73A(Special),79A	B8A 7325532-3-A	2-B8A 5728506-A	Retainer			
	59B, 66B, 70	B8A 7029038-9-C					
	59A, 66A, 70A,& 70D(Special),78	B8A 7029038-9-D					
57	57A,58B	B7A 5725334-5-A	1-37611-S7	Screw	1-B7A 5825553-B	Retainer	B7A 211-A
			3-354397-S100	Nut & washer	1-B7A 5825562-A	Retainer	
			1-B7A 6428820-A	Retainer	1-BN 7029120-A	Retainer	
			2-B7A 6429144-A	Retainer			
58	73	B8A 7325532-3-B	1-37611-S7	Screw	1-BM 7029120-A	Retainer	B8A 211-A
	79C, 79D	B8A 7925532-3-A	3-354397-S100	Nut & washer	1-B8A 7325553-A	Retainer	
			2-B7A 5929120-A	Retainer			
53	73B,79B	BF 7325532-3-A	1-34053-S8	Nut	1-357118-S8	Clip	B3A 212-A
			1-34903-S8	Washer	1-358484-S8	Clip	
			1-44716-S8	Washer			
56	57	B6A 5725532-A	2-34053-S8	Nut	2-B6A 7029144-A	Clip	B6A 212-A
	73C,79B	B6A 7325532-A	2-B6A 7021094-D	Retainer			
57	57B, 58A	B7A 5825532-3-A	1-37611-S8	Screw	1-B7A 6429144-E	Retainer	B7A 212-A
			3-354397-S100	Nut & washer	1-B7A 5825553-B	Retainer	
			3-B7A 5929120-A	Retainer			
58	73,79C,79D	B8A 7325532-3-C	3-354397-S100	Nut & washer	1-BM 7029120-A	Retainer	B8A 212-A
			2-B8A 5728506-A	Retainer	1-B6A 7029120-C	Retainer	

† No Longer Supplied Service Details

MOULDING CLIP KITS
NOTE - Each Kit Contains Sufficient Clips Etc. For Attaching
Click Here To Order
BUY IT NOW!

Year	Model or Body Type	Part Number of Moulding Used With	Components of Kit				Kit Number
56	73A, 73B, 79D	B6A 7325532-3-A	1-34052-S8 Nut 1-B6A 7021066-C Retainer	1-B6A 7021094-G Retainer Replaced by B6A 208-A			*B6A 213-A
57	73A	B7A 7325532-3-A	1-57611-S7 Screw 3-354397-S100 Nut & washer 1-B7A 5929120-A Retainer	1-B7A 7029120-A Retainer 1-B7A 7029288-A Retainer 1-B7A 7325553-A Retainer			B7A 213-A
57	73B 79C, 79D	B7A 7325532-3-B B7A 7925532-3-B	1-37611-S7 Screw 4-354397-S100 Nut & washer 1-B7A 5929120-A Retainer	2-B7A 7029120-A Retainer 1-B7A 7321096-A Retainer 1-B7A 7325553-A Retainer			B7A 214-A
58	73, 79C, 79D 59B, 70	B8A 7325540-1-A B8A 7029140-1-A	1-354397-S100 Nut & washer 1-B8A 5728506-A Retainer	1-BM 7029120-A Retainer 1-B6A 7029120-C Retainer Replaced by B8A 212-A			*B8A 214-A
52/54	73, 79	BA 7325554-5-A	2-357568-S8 Clip	6-357862-S2 Clip			B2A 215-A
55	70B 73B	B5A 7029034-5-A B5A 7325554-5-A	3-B5A 7021060-A Retainer	2-B5A 7021062-A Retainer			B5A 215-A
57	73B, 79C, 79D	B7A 7325540-1-A	1-354397-S100 Nut & washer 1-358566-S100 Clip	2-B7A 7020232-A Retainer 2-B7A 7350992-A Retainer			B7A 215-A
55	73C	B5A 7325554-5-C	1-31061-S8 Screw 1-34938-S8 Washer 3-B5A 7021060-A Retainer	2-B5A 7021062-A Retainer 1-B5A 7325526-A Retainer			B5A 216-A
58	57B, 58A 57B, 58A 63B, 64A 63B, 64A 51A, 63A, 64B, 76B	B8A 5725556-7-A B8A 5725586-7 B8A 6429068-9-A B8A 6429076-7-A B8A 6429076-7-B	2-354397-S100 Nut & washer 2-B8A 5728506-A Retainer	3-B8A 7021094-A Retainer			B8A 216-A
54	73B, 73C, 79B	BM 7325556-7-B	3-34053-S8 Nut 3-34903-S8 Washer 1-358552-S100 Clip	1-B5A 7021060-A Retainer 2-BM 7029120-A Retainer			B4A 217-A
52/54	70	BA 7029034-5-A	6-34053-S8 Nut 6-34903-S8 Washer	6-357769-S7 Retainer 5-357862-S2 Clip			B2A 300-A
55	70C	B5A 7029034-5-C	1-34053-S8 Nut 1-34803-S7 Washer 3-B5A 7021060-A Retainer	1-B5A 7021062-A Retainer 1-B5A 7029130-A Retainer			B5A 300-A
57	59A, 78A	B7A 5929028-9-A	5-35397-S100 Nut & washer 1-B7A 5929120-A Retainer	1-B7A 5929120-B Retainer 2-B7A 7029120-A Retainer			B7A 300-A
58	59B, 66B, 70, 73, 79C, 79D 59B, 66B, 79C, 79D 59B, 66B, 79C, 79D	B8A 7028016-7-A B8A 5928685-A B8A 5928698-A	3-354397-S100 Nut & washer	2-358566-S100 Retainer			†B8A 300-A
52/54	73	BA 7329034-5-A	7-34053-S8 Nut 7-34903-S8 Washer	7-44716-S8 Washer 7-357769-S7 Retainer			†B2A 301-A
58	59B, 66B, 70	B8A 7028044-5-A	1-354397-S100 Nut & washer 1-358566-S100 Retainer	Replaced by B8A 303-A 8-B8A 5728506-A Retainer			B8A 301-A
59	51A, 54A, 57A, 58B, 63A, 64B, 64H, 65A, 75A, 76B	B9A 6329038-9-A	4-354397-S100 Nut & washer 1-B8A 5728506-A Retainer 3-B9A 6329120-A Retainer	6-B9A 6329144-A Retainer 2-B9A 6429144-A Retainer			B9A 301-A

† No Longer Supplied Service Details

1949-1959 FORD CAR PARTS AND ACCESSORIES

ILLUSTRATIONS CATALOG

1949-1959 CHASSIS

1953-1959 BODY

**PARTS AND ACCESSORIES OPERATIONS
FORD DIVISION  MOTOR COMPANY**

COPYRIGHT © 1964—FORD MOTOR COMPANY • DEARBORN, MICHIGAN



& RELATED PARTS

**SECTIONS 10-24
WHEELS, BRAKES**

28

**SECTIONS 30-46
FRONT SUSPENSION, STEERING,
REAR AXLE, DRIVE SHAFT**

55

**SECTIONS 50-53
FRAME, MUFFLER, SPRINGS**

105

**SECTIONS 60-66
ENGINE**

141

**SECTIONS 70-75
STANDARD TRANSMISSION, CLUTCH**

194

**SECTIONS A70-A76
AUTOMATIC TRANSMISSION**

224

**SECTIONS 80-85
COOLING, GRILLE**

253

**SECTIONS 90-98
FUEL, CARBURETOR, ACCELERATOR**

277

**SECTIONS 100-120
GENERATOR, ALTERNATOR,
STARTER, DISTRIBUTOR**

358

**SECTIONS 130-150
LAMPS, WIRING**

384

**SECTIONS 160-166
FENDER, HOOD**

457

**SECTIONS 175-190
SPEEDOMETER, BUMPER, ACCESSORIES**

484

**BODY SECTIONS 000-042
BODY FRONT, FLOOR**

563

**BODY SECTIONS 230-290
BODY SIDE, QUARTER**

574

**BODY SECTIONS 400-500
BACK, LUGGAGE COMPARTMENT**

637

**BODY SECTION 600
SEATS**

681

BODY SHEET METAL SECTION

700

EXTERIOR MOULDING SECTION

761

INTERIOR TRIM SECTION

868

**1949/59 PASSENGER CAR
PARTS and ACCESSORIES ILLUSTRATION**

FORM FD-9463



FORD DIVISION  MOTOR COMPANY

DISTRICT OFFICES

Atlanta (East Point, Ga.)	Denver, Colo.	Louisville, Ky.	Pittsburgh, Pa.
Boston (Natick, Mass.)	Des Moines, Iowa	Memphis, Tenn.	Richmond, Va.
Buffalo, N. Y.	Detroit (Livonia, Mich.)	New Orleans (Arabi, La.)	Rockford, Ill.
Charlotte, N. C.	Fargo, N. D.	Newark (Teterboro, N. J.)	St. Louis (Clayton, Mo.)
Chicago (Melrose Park, Ill.)	Houston, Texas	New York (White Plains, N. Y.)	Salt Lake City, Utah
Cincinnati, Ohio	Indianapolis, Ind.	Oklahoma City, Okla.	San Jose, Calif.
Cleveland, Ohio	Jacksonville, Fla.	Omaha, Neb.	Seattle, Wash.
Dallas, Texas	Kansas City, Mo.	Philadelphia (Pennsauken, N. J.)	Twin City (Minneapolis, Minn.)
Davenport, Iowa	Lansing, Mich.	Phoenix, Ariz.	Washington, D. C.
	Los Angeles		
	(Pico-Rivera, Calif.)		

INDEX FOR GENERAL INFORMATION and MODEL IDENTIFICATION SECTIONS

Abbreviations	V	Patent Plate Diagram and Explanation	VIII
BODY PARTS ILLUSTRATIONS GENERAL INDEX	VII	Patent Plate Codes	
Body Type Codes	IV	Assembly Plant	IX
Carburetor Catalog Symbols	IV	Body Style	XI
Catalog Model Codes	IV	Body Type	X
CHASSIS PARTS ILLUSTRATIONS GENERAL INDEX	VII	District	IX
District Offices	II	Engine (Horsepower Rating)	IX
Explanation of Symbol ★	IV	Exterior Paint Body Color	XIV, XV
Ford Group and Basic Number Chart	VI	Model Year	IX
General Instructions	II	Months of the Year	IX
How to Order Parts	IV	Rear Axle Ratio	IX
Model Identification	XVI thru XXII	Transmission Type	IX
Model Years	III	Trim Scheme	XI, XII, XIII
Procedure for Using Catalog	III		
Quick Reference Index	I		
Section, Group and Basic Numbers	III		

GENERAL INSTRUCTIONS

This Ford Parts and Accessories Catalog contains parts illustrations for the Ford passenger car line including Thunderbird, and is to be used in conjunction with "Text" Catalog, Form FD-9462.

Following are the model years for which illustrations are provided in this catalog:

Chassis Parts	1949 through 1959
Body Parts	1953 through 1959
Soft Trim Parts	1956 through 1959

The driver's side is the left hand side of the vehicle and should govern in determining such parts as fenders, lamps, etc. as to whether a part is right or left hand.

FORD CAR PARTS

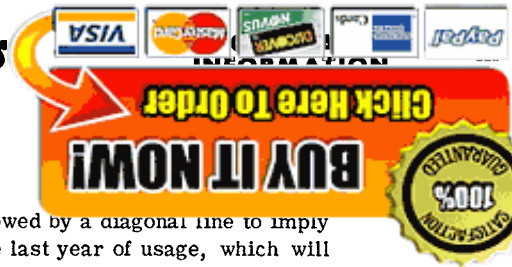

MODEL YEARS

Model year application is indicated by showing the first year followed by a diagonal line to imply continued usage in all subsequent years until the insertion of the last year of usage, which will then be inserted after the diagonal line. If no diagonal line is shown the illustration is applicable only to the year shown.

Example: 49 indicates part used 1949 model year only.
49/59 indicates part used 1949 through 1959 model years.
55/ indicates part used 1955 through 1959 and subsequent model years as indicated in the appropriate catalog for 1960 and up.

SECTION, GROUP and BASIC NUMBERS

For greater convenience this catalog is divided into sections to conform with the Master Parts Catalogs.

Section Numbers are related to group numbers as follows:

SECTION NUMBER	GROUP NUMBER SERIES	PART NAME
10	1000 - 1999	Wheel Parts
20	2000 - 2999	Brake Parts

Refer to Pages VI and VII for more information on Ford group and basic part numbers.

The "Text" Catalog is divided into sections also and like parts are shown under similar section numbers in both the "Text" and "Illustrations" catalogs.

Illustrations contain basic group numbers only, therefore, it is necessary to refer to the basic group within the "Text" Catalog listing for complete applicable part number.

Some basic numbers include an alphabetical character in addition to the numerical digits shown in the charts on page VI. In the "Text" Catalog basic numbers expanded by an alphabetical character follow the numerical basic numbers from which they are expanded and are listed in the manner shown below:

2047 Nut - Brake Adjusting Screw
2A047 Hose - Power Brake Booster Reservoir to Manifold

PROCEDURE FOR USING CATALOG

Following is a recommended procedure for using this catalog:

Should an inquiry be received for a grease baffle for the brakes of a 1955 passenger model vehicle, use the following steps.

- A. Refer to the section and page designated on the cover or in the General Index on Page VII for "Brakes".
- B. On the designated page (28) is an index of various brake types and systems.
- C. Refer to the "Front and Rear Brakes" and locate the 1955 brake as applicable.
- D. Refer to illustration on Page 41 and identify the proper part which will show the group number as 2060.
- E. Refer to Group 2060 in the "Text" Catalog, Form FD-9462, and locate the year 1955 in the column headed "Year". Refer then to column headed "Model" for "A" which indicates passenger car. The part number will be shown as AD 2060-C.



BODY TYPE CODES

Various body illustrations are identified with Body Type Codes. A complete listing of the codes and the body types which they represent is shown on Page X. Body types which are similar are identified by the same code number; alphabetical suffixes are used to identify a particular body type. For instance, in 1959 Code 58 was used as follows:

BODY TYPE CODE	BODY TYPE
58A	Fairlane Town Sedan
58B	Fairlane "500" Town Sedan
58E	Custom "300" Fordor Sedan

The body type numbers only are shown on those illustrations which are applicable to all body types of a related group. For instance, Body Type Code 58 includes 58A, 58B and 58E.

CATALOG MODEL CODES

Codes shown in the "Text" Catalog under heading "Model" are to be interpreted as follows:

A	Passenger Car	F/M/2	FORDOMATIC 2 SPEED TRANSMISSION	S/C	Supercharger
A/C	Air Conditioner	M/L	Mainline	S/D	*Sedan Delivery
A/S	Air Suspension	O/D	Overdrive	S/L	Sunliner
C/L	Customline	P/I	Police Interceptor	S/T	Standard Transmission
C/M	Cruise-O-Matic	P/L	Parklane	S/W	*Station Wagon
F/L	Fairlane	P/S	Power Steering		
F/M	FORDOMATIC TRANSMISSION	S	Thunderbird		

☪ Includes parts common to Station Wagon, Sedan Delivery, Ranchero, Police Interceptor when applicable.

* Models S/D and S/W when shown separately apply to parts peculiar to Sedan Delivery and Station Wagons.

CARBURETOR CATALOG SYMBOLS

Some illustrations in Section 95 are identified with carburetor catalog symbols. The carburetor catalog symbols are identical with the carburetor parts list numbers shown in the Carburetor Identification Chart in Section 95 of the "Text" Catalog, Form FD-9462, and apply to the same carburetors.

EXPLANATION OF SYMBOL ★

- ★ Symbol indicates part is not supplied for service due to the following:
 - a. Due to its function there would be little or no demand.
 - b. Part can be improvised as indicated in the description column of "Text" Catalog.

HOW TO ORDER PARTS

When ordering parts, always give the complete part number. In the event the part number is not known, the following information should be included.

- A. Complete description of part.
- B. Model year and body type.
- C. Dimension, number of teeth, size, etc.; if possible rough sketch of part.
- D. If applicable to engine, transmission, axle, steering, etc.; specify type; such as 312 cubic inch, Fordomatic, Power Steering, etc.
- E. Advise how shipment is to be made - Freight, Express, Air, Parcel Post.

FORD CAR PARTS

ABBREVIATIONS



2/b or 2/v..... 2 barrel
 3/T..... 3 speed trans.
 4/b or 4/v..... 4 barrel
 4/T or 4/S/T..... 4 speed trans.
 6/b or 6/V..... 6 barrel
 abs..... absorber
 A/C..... air conditioner
 altnr..... alternating
 accel..... accelerator
 adj..... adjustment
 alum..... aluminum
 amp..... ampere
 approx..... approximately
 AR..... As Required
 assy..... assembly
 A/S..... air suspension
 attach..... attached

blk..... block
 brg..... bearing
 brkt..... bracket
 brkr..... breaker
 bus..... business

carb..... carburetor
 C/CW..... counter clockwise
 C. I. D..... cubic inch displacement
 C/L..... Customline
 C/M..... cruise-o-matic
 C. P..... candle power
 clstr..... cluster
 c/member..... crossmember
 col..... column
 com..... compressor
 compt..... compartment
 cond..... conditioning
 conn..... connecting
 con..... control
 cvr..... cover
 cov..... cover
 cp..... candle power
 c/pin..... cotter pin
 c/shaft..... crankshaft
 ctr..... center
 C/W..... clockwise
 cyl..... cylinder

def..... defroster
 defl..... deflector
 dia..... diameter
 diam..... diameter
 diff..... differential
 disp..... displacement
 dist..... distributor

elec..... electric
 eng..... engine
 equal..... equalizer

exh..... exhaust
 ext..... external

fdr..... fender
 fill..... fillister
 frt..... front
 F/L..... Fairlane
 flr..... floor
 F/M..... Fordomatic
 F/M/2..... Fordomatic 2 speed
 ft..... foot
 f/wheel..... flywheel
 flex..... flexible

gen..... generator
 gov..... governor

H/D..... heavy duty
 hd..... head
 hex..... hexagon
 HP..... horsepower
 htr..... heater
 hsg..... housing
 hyd..... hydraulic

I. D..... inside diameter
 identi..... identification
 indic..... indicator
 int..... internal
 ign..... ignition
 instru..... instrument
 inter..... intermediate

lb..... pound
 L. H..... left hand
 lt./frame..... light weight frame
 lub..... lubricator
 l/w..... lockwasher
 l/washer..... lockwasher
 lwr..... lower

man..... manifold
 med..... medium
 M/L..... Mainline
 mldg..... moulding
 mtd..... mounted
 mtg..... mounting
 mtr..... motor

No..... number

o/all..... overall
 O. D..... outside diameter
 O/D..... overdrive
 o/drive..... overdrive
 O. H. V..... over head valve
 o/s..... oversize
 oz..... ounce

P/L..... Pa.
 press..... pressure
 P/S..... power steering
 pt..... pint

qtr..... quarter
 qty..... quantity

rad..... radiator
 rd..... round
 reg..... regulator
 reinf..... reinforcement
 repl..... replaced
 ret..... retainer

R. H..... right hand
 R. P. M..... revolutions per minute

S/C..... Supercharger
 S/D..... Sedan Delivery
 S/L..... Sunliner

speedo..... speedometer
 sprg..... spring
 s/ring..... snap ring
 std..... standard
 strg..... steering

S/T..... standard transmission
 suppt..... support
 susp..... suspension
 S/W..... Station Wagon

tach..... tachometer
 temp..... temperature
 thd..... thread
 trans..... transmission
 T. V..... throttle valve

u/joint..... universal joint
 u/s..... undersize

vac..... vacuum
 vent..... ventilation

w/..... with
 w/o..... without
 w/s..... windshield

w/shield..... windshield
 w/strip..... weather strip
 warn..... warning
 wt..... weight

x/c..... extra cooling



Click Here To Order

BUY IT NOW!



FORD GROUP AND BASIC PART NUM

Ford group and basic part numbers are grouped according to their function; for example, all parts applying to the rear axle are grouped from 4000 to 4296, transmission and clutch from 6905 to 7997, etc.

Following is an index and section number of the various groups--

GROUP AND BASIC PART NO. SERIES	GROUP NAME	SECTION	GROUP AND BASIC PART NO. SERIES	GROUP NAME	SECTION
1000-1250	Wheels, hubs and drums	10	11000-11382	Starter motor	110
1350-1499	Spare wheel carrier	10	11450-11688	Lighting & ignition switch	110
2001-2285	Brakes (service)	20, 22	12000-12390	Ignition coil, distributor, condenser	120
2307-2438	Brakes (power)	23	12402-12425	Spark plug	120
2442-2482	Brake controls	24	13002-13248	Lamps (head and parking)	130
2505-2900	Brakes (parking)	24	13402-13796	Lamps (rear)	134, 137
3000-3359	Front suspension and steering linkage	30	13809-13853	Lamps (license and pillar) & horn	137
3500-3764	Steering gear	35, 36	14197-14689	Wiring	140, 145
4000-4296	Rear axle	40	15000-15858	Miscellaneous accessories	150
4600-4859	Drive shaft	46	16000-16550	Front fender	160
5000-5176	Frame	50	16600-16999	Hood	166
5200-5299	Muffler & exhaust pipe	52	17005-17125	Tools	170
5300-5499	Front spring & stabilizer	53	17248-17383	Speedometer & tachometer	170, 172
5550-5832	Rear spring	53	17402-17666	Windshield wiper & washer	172, 175, 176
6000-6898	Engine	60, 61, 62, 63, 65, 66	17700-17730	Mirror	176
6905-6968	Transmission overdrive & engine steady rest	69, 70	17736-17999	Bumper	176
7000-7997	Transmission and clutch	70, 71, 72, 73, 75, 76	18000-18125	Shock absorber	180
7000-7997	Automatic Transmission	A70, A71, A72, A73, A75, A76	18148-18994	Miscellaneous accessories	180, 182, 184
8000-8499	Radiator and grille	80	19500-19585	Appearance and maintenance materials	Paint
8500-8689	Water pump and fan	85	19600-19980	Air conditioner	190
9002-9296	Fuel tank & supercharger	90	4000000 & Up	Body Parts	
9301-9420	Fuel pump	93, 94	BODY SECTION		
9421-9499	Manifolds, clamps, etc.	94		Body front	000
9500-9599	Carburetor & supercharger	95, 95A, 95B		Windshield	030
9600-9699	Air cleaner	96		Instrument panel	042
9700-9999	Accelerator & choke control rods	97		Floor	100
10000-10449	Generator & Alternator	100		Front door	200, 210, 220, 230
10500-10653	Voltage regulator	100, 106		Rear door	240, 260
10654-10756	Battery	106		Quarter	270, 280, 290, 295, 300
10838-10990	Instruments	106		Back window and luggage compartment	400, 420, 430, 440
				Roof, folding top	500, 510, 520, 530
				Seats	600, 610, 620

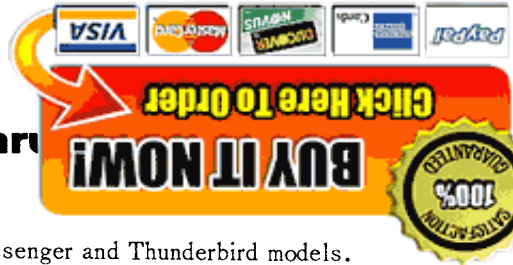

TYPICAL PATENT PLATE - thru

The Patent Plate is located on the left front body pillar on all passenger and Thunderbird models.

The following diagram of the Patent Plate specifies, in the Serial Number: the Engine Type, Model Year, Plant which assembled the car, Body Style and numerical sequence of assembly.

Indicated in the body specifications are the Body Type, Exterior Paint Color, Trim Scheme, Production Date, Transmission Type and Rear Axle Ratio.

IMPORTANT Always furnish appropriate Patent Plate information and DSO number if applicable when ordering parts not listed in the Catalog.

PATENT PLATE DIAGRAM

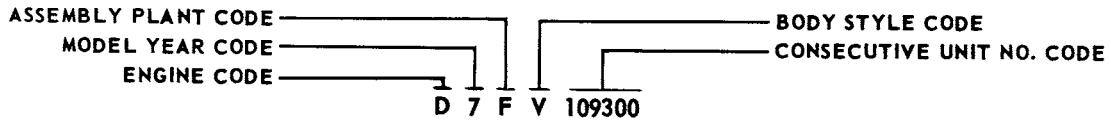

- Serial Number (D7FV109300)
 "D" -- 8 cyl. OHV Engine -- 312 cu. in. disp. -- 4-venturi carb.
 "7" -- 1957 Model
 "F" -- Assembled at Dearborn Plant
 "V" -- Victoria body style -- Fairlane or Fairlane "500"
 "109300" -- Nine thousand, three hundredth car assembled.

SERIAL	NUMBER	MADE IN	<i>Ford</i>		REG. U. S.
D7FV	109300	U.S.A. BY			PAT. OFF.
BODY	COLOR	TRIM	DATE	TRANS	AXLE
63B	CE	H-1	17K	3	1

THIS VEHICLE IS CONSTRUCTED UNDER UNITED STATES LETTER PATENTS
 2 270 122 2 590 719 2 628 833 2 677 572 2 708 594
 2 290 927 2 612 829 2 631 694 2 677 574 2 726 894
 2 310 416 2 617 681 2 639 938 2 698 012
OTHER PATENTS PENDING

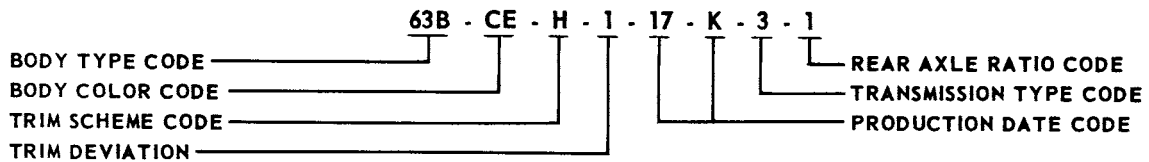

- Style and Body Specifications (63B - CE - H - 1 - 17K - 3 - 1)**
 "63B" -- Victoria -- Fairlane Tudor
 * "CE" -- Dresden Blue lower body, Colonial White upper body
 "H" -- Colonial Vinyl and Blue Tropical-Leaf Fabric Bodycloth
 "1" -- First Trim Deviation
 "17" -- Seventeenth Day of Month
 "K" -- Month of year -- October
 "3" -- Fordomatic Transmission
 "1" -- Rear Axle Ratio of 3.10 to 1.

* When vehicle is two-toned the lower body color code will appear first in the Paint Color Code space.

FORD CAR PARTS



PATENT PLATE - CONTINUED

REAR AXLE RATIO CODES					
REAR AXLE RATIO	REGULAR 1955/59	LOCKING DIFF. 1959	REAR AXLE RATIO	REGULAR 1955/59	LOCKING DIFF. 1959
2.69 to 1	6	F	3.70 to 1	3	C
2.91 to 1	5	F	3.89 to 1	4	D
3.10 to 1	1	A	4.11 to 1	0	
3.56 to 1	2	B			

MODEL YEAR CODES							
CODE	YEAR	CODE	YEAR	CODE	YEAR	CODE	YEAR
3	1953	5	1955	7	1957	9	1959
4	1954	6	1956	8	1958		

ASSEMBLY PLANT CODES							
CODE	ASSEMBLY PLANT	CODE	ASSEMBLY PLANT	CODE	ASSEMBLY PLANT	CODE	ASSEMBLY PLANT
A	Atlanta	G	Chicago	M	Memphis	T	Metuchen
C	Chester	H	Lorain	N	Norfolk	U	Louisville
D	Dallas	J	Los Angeles	P	Twin Cities	W	Wayne
E	Mahwah	K	Kansas City	R	San Jose	Y	Wixom
F	Dearborn	L	Long Beach	S	Pilot Plant	Z	St. Louis

TRANSMISSION TYPE CODES			
CODE	TRANSMISSION	CODE	TRANSMISSION
1	3 Speed Manual Shift	C	Fordomatic (3-speed)
2	Overdrive	5	4 Speed Manual Shift
3	Fordomatic (2-speed)	6	Cruise-O-Matic
4	Cruise-O-Matic		(3-speed dual range)

MONTHS OF THE YEAR CODES								
MONTH	YEAR First	YEAR Second	MONTH	YEAR First	YEAR Second	MONTH	YEAR First	YEAR Second
January	A	N	May	E	S	September	J	W
February	B	P	June	F	T	October	K	X
March	C	Q	July	G	U	November	L	Y
April	D	R	August	H	V	December	M	Z

DISTRICT CODES

CODE	DISTRICT	CODE	DISTRICT	CODE	DISTRICT	CODE	DISTRICT	CODE	DISTRICT
11	Boston	23	Philadelphia	34	Indianapolis	45	Davenport	62	Houston
12	Buffalo	24	Jacksonville	35	Lansing	51	Denver	63	Memphis
13	New York	25	Richmond	36	Louisville	52	Des Moines	64	New Orleans
14	Pittsburgh	26	Washington	41	Chicago	53	Kansas City	65	Oklahoma City
15	Newark	31	Cincinnati	42	Fargo	54	Omaha	71	Los Angeles
21	Atlanta	32	Cleveland	43	Rockford	55	St. Louis	72	San Jose
22	Charlotte	33	Detroit	44	Twin Cities	61	Dallas	73	Salt Lake City
								74	Seattle
								81	Ford of Canada
								83	Government
								84	HOME OFFICE RESERVE
								85	AMERICAN RED CROSS
								89	TRANSPORTATION SERVICES
								90	's Export

ENGINE CODES and HORSEPOWER RATINGS

ENGINE Cyl.	C.I.D.	TYPE	1952/53		1954		1955		1956		1957		1958		1959	
			CODE	H.P.	CODE	H.P.	CODE	H.P.	CODE	H.P.	CODE	H.P.	CODE	H.P.	CODE	H.P.
6	215	OHV	A	101												
8	239	L-HEAD	P	110												
8	239	L-HEAD	B													
6	223	OHV			A	115	A	120	A	137	A	144				
8	239	OHV			U	130										
8	256	OHV			P	161										
8	272	OHV-2V, Carb. -Standard					U	162	U	173	B	190				
8	272	OHV-2V, Carb. -Automatic					U	162	U	176	B	190				
8	272	OHV-4V, Carb. -Automatic					M	182								
8	292	OHV-2V, Carb. -Standard									C	206				
8	292	OHV-2V, Carb. -Automatic									C	212				
8	292	OHV-4V, Carb. -Standard					P	193	M	200						
8	292	OHV-4V, Carb. -Automatic					P	198	M	202						
8	312	OHV-4V, Carb. -Standard							P	215	D	245				
8	312	OHV-4V, Carb. -Automatic							P	225	D	245				
8	312	OHV-4V, Carb. (Supercharger)									F	300				
8	312	OHV-8V, Carb. (Hi-Performance Special)									E	270				
8	312	OHV-8V, Carb. (Racing)									E	285				
6	223	OHV-1V.											A	145	A	145
8	292	OHV-2V, Carb. -Standard											C	205	C	200
8	292	OHV-2V, Carb. -Automatic											C	205		
8	332	OHV-2V, Carb.											B	240	B	225
8	332	OHV-4V, Carb. (Special)											G	265		
8	352	OHV-4V, Carb. (Power option)											H	300	H	300
8	361	OHV-4V, Carb. (Police)												303		
8	430	OHV-4V, Carb. -Automatic											J	375	J	375

PATENT PLATE - CONTINUED
TRIM SCHEME CODES

CODE	TRIM SCHEME	CODE	TRIM SCHEME
1957			
A	Silver and Gray Shantung Vinyl and Gray Random Block Fabric	AJ	Colonial Vinyl and Red Silver-Shadow Fabric
E	Starmist Chain-Grain Vinyl and Blue Silver-Dash or Blue Flying-Dart Fabric	AN	Willow Chain-Grain Vinyl and Green Flying-Dart or Green Silver-Dash Fabric
F	Woodsmoke Chain-Grain Vinyl and Gray Silver-Dash or Gray Flying-Dart Fabric	AR	Blue Basket-Weave Fabric and Blue Sculptured Fabric
G	Doeskin Chain-Grain Vinyl and Brown Silver-Dash Fabric	AS	Green Basket-Weave Fabric and Green Sculptured Fabric
H	Colonial Vinyl and Blue Tropical-Leaf or Blue Silver-Shadow Fabric	AT	Raven Vinyl and Gold Ripple-Wave Fabric
J	Colonial Vinyl and Green Tropical-Leaf or Green Silver-Shadow Fabric	AU	Colonial Vinyl and Flame Embossed or Pleated Flame Vinyl
K	Colonial Vinyl and Gray Tropical-Leaf Fabric	AX	Doeskin Vinyl and Tan Sharkskin Woven Plastic
L	Colonial Vinyl and Brown Tropical-Leaf or Brown Silver-Shadow Fabric	AZ	Colonial Vinyl and Tan Silver-Tweed Woven or Tan Silver-Tweed Puff Woven Plastic
R	Gray Basket-Weave Fabric and Gray Sculptured Fabric	BC	Blue Airweave Vinyl
S	Brown Basket-Weave Fabric and Brown Sculptured Fabric	BD	Green Airweave Vinyl
T	Gold Basket-Weave Fabric and Black Sculptured Fabric	BE	Black Airweave Vinyl
U	Colonial Vinyl and Black Silver-Shadow Fabric	BF	Red Airweave Vinyl
X	Colonial Vinyl and Blue Silver Tweed Woven or Blue Silver Tweed Puff Woven Plastic	BG	Brown Airweave Vinyl
AA	Colonial Vinyl and Raven Embossed Vinyl		
AB	Colonial Vinyl and Dresden Embossed or Blue French Stitch Vinyl		THUNDERBIRD
AC	Colonial Vinyl and Cumberland Embossed or Pleated Cumberland Vinyl	XA	Pleated Raven Vinyl and Pleated Colonial Vinyl
		XH	Pleated Flame Vinyl
		XJ	Pleated Bronze Vinyl
		XK	Pleated Colonial Vinyl
		XL	Pleated Dresden Vinyl and Pleated Starmist Vinyl
		XM	Pleated Cumberland Vinyl and Pleated Willow Vinyl

1958

A	Silver Shantung Vinyl and Silver Lattice-Pattern Fabric	Z	Colonial Sof-Textured Vinyl and Black Whipcord Embossed Vinyl
C	Blue Sof-Textured Vinyl and Blue Box-Striped Fabric or Blue Random-Block Patterned Fabric or Blue Royal Scot Tweed	AB	Beige Sof-Textured Vinyl and Shadow Pattern Woven Plastic
D	Green Sof-Textured Vinyl and Green Box Striped Fabric or Green Random-Block Patterned Fabric or Green Royal Scot Tweed	AC	Blue Sof-Textured Vinyl and Blue Basket Weave Plastic or Blue Thong Patterned Plasti-Fab
E	Gray Sof-Textured Vinyl and Gray Box-Striped Fabric or Gray Random-Block Patterned Fabric	AH	Beige Sof-Textured Vinyl and Brown Basket Weave Plastic or Brown Thong Patterned Plasti-Fab
F	Beige Sof-Textured Vinyl and Brown Random-Block Patterned Fabric or Brown Royal Scot Tweed	AJ	Gray Shadow-Block Patterned and Gray Damask Cloth
G	Colonial Sof-Textured Vinyl and Black Random-Block Patterned Fabric or Black Royal Scot Tweed	AK	Colonial Sof-Textured Vinyl and Gulfstream Royal Scot Tweed
H	Colonial Sof-Textured Vinyl and Palomino Royal Scot Tweed	AL	Colonial Sof-Textured Vinyl and Gulfstream Whipcord Embossed Vinyl
J	Blue Shadow-Block Patterned and Blue Damask Cloth	AM	Gold Sof-Textured Vinyl and Black Royal Scot Tweed
K	Green Shadow-Block Patterned and Green Damask Cloth	*CZ	Blue Sof-Textured Vinyl and Blue Random-Block Patterned Fabric
L	Brown Shadow-Block Patterned and Brown Damask Cloth	*DZ	Green Sof-Textured Vinyl and Green Random-Block Patterned Fabric
R	Black Shadow-Block Patterned and Gold Damask Cloth	*EZ	Gray Sof-Textured Vinyl and Gray Random-Block Patterned Fabric
S	Colonial Sof-Textured Vinyl and Red Royal Scot Tweed		THUNDERBIRD
U	Blue Sof-Textured Vinyl and Blue Whipcord Embossed Vinyl or Blue Embossed-Stitch Vinyl	XA	Blue Sof-Textured Vinyl and Blue Highland Tweed
V	Green Sof-Textured Vinyl and Green Whipcord Embossed Vinyl or Green Sof-Textured Vinyl	XB	Green Sof-Textured Vinyl and Green Highland Tweed
X	Colonial Sof-Textured Vinyl and Palomino Whipcord Embossed Vinyl	XC	Black Sof-Textured Vinyl and Black Highland Tweed
Y	Colonial Sof-Textured Vinyl and Red Whipcord Embossed Vinyl or Red Sof-Textured Vinyl	XE	Blue and White Sof-Textured Vinyl
		XF	Green and White Sof-Textured Vinyl
		XG	Red and White Sof-Textured Vinyl
		XH	Black and White Sof-Textured Vinyl
		XK	Gulfstream Sof-Textured Vinyl and Gulfstream Highland Tweed
		XL	Palomino and White Sof-Textured Vinyl
		XM	Gulfstream and White Sof-Textured Vinyl

* Used on Body Types 70B and 73B after May 9, 1958



PATENT PLATE - CONTINUED
TRIM SCHEME CODES



1959

CODE	TRIM SCHEME	CODE	TRIM SCHEME
02	Blue Ribbed Vinyl Bolster and Blue Random Block Fabric	57	Radiant Colonial White Sof-Textured Vinyl Bolster and Torch Red Striped Nub Fabric with Silver Strand
03	Green Ribbed Vinyl Bolster and Green Random Block Fabric	58	Radiant Colonial White Sof-Textured Vinyl Bolster and Torch Red Shantung Pattern Vinyl
07	Blue Tweedweave Fabric Bolster and Blue Linen-Pattern Cloth with Silver Fleck	59	Medium Blue Shantung Vinyl
08	Green Tweedweave Fabric Bolster and Green Linen-Pattern Cloth with Silver Fleck	60	Medium Brown Shantung Vinyl
09	Bronze Tweedweave Fabric Bolster and Bronze Linen-Pattern Cloth with Silver Fleck	024	Radiant Blue Sof-Textured Vinyl Bolster and Blue Shadowweave Fabric
10	Gray Tweedweave Fabric Bolster and Gray Linen-Pattern Cloth with Silver Fleck	032	Radiant Green Sof-Textured Vinyl Bolster and Green Shadowweave Fabric
11	Turquoise Tweedweave Fabric Bolster and Turquoise Linen-Pattern Cloth with Silver Fleck	111	Turquoise Tweedweave Fabric Bolster and Turquoise Linen-Pattern Cloth with Silver Fleck
12	Gray Tweedweave Fabric Bolster and Gold Linen-Pattern Cloth with Silver Fleck	121	Gray Tweedweave Fabric Bolster and Gold Linen-Pattern Cloth with Silver Fleck
25	Blue Sof-Textured Vinyl Bolster and Blue Lattice Pattern Plasti-Fab Weave	296	Radiant Silver Sof-Textured Vinyl Bolster and Gunsmoke Shadowweave Fabric
26	Fawn Sof-Textured Vinyl Bolster and Bamboo Pattern Vinyl	301	Blue Tweedweave Fabric Bolster and Blue Linen-Pattern Cloth with Silver Fleck
29	Gunsmoke Ribbed Vinyl Bolster and Gunsmoke Random Block Fabric	302	Radiant Blue Sof-Textured Vinyl Bolster and Blue Striped Nub Fabric with Silver Strand
30	Radiant Blue Sof-Textured Vinyl Bolster and Blue Shadowweave Fabric	311	Green Tweedweave Fabric Bolster and Green Linen-Pattern Cloth with Silver Fleck
30	Radiant Blue Sof-Textured Vinyl Bolster and Blue Striped Nub Fabric with Silver Strand	312	Radiant Green Sof-Textured Vinyl Bolster and Green Striped Nub Fabric with Silver Strand
31	Radiant Green Sof-Textured Vinyl Bolster and Green Shadowweave Fabric	323	Gray Tweedweave Fabric Bolster and Gray Linen-Pattern Cloth with Silver Fleck
31	Radiant Green Sof-Textured Vinyl Bolster and Green Striped Nub Fabric with Silver Strand	331	Bronze Tweedweave Fabric Bolster and Bronze Linen-Pattern Cloth with Silver Fleck
32	Radiant Silver Sof-Textured Vinyl Bolster and Gunsmoke Shadowweave Fabric	331	Radiant Bronze Sof-Textured Vinyl Bolster and Bronze Shadowweave Fabric
33	Radiant Bronze Sof-Textured Vinyl Bolster and Bronze Shadowweave Fabric	332	Radiant Bronze Sof-Textured Vinyl Bolster and Bronze Striped Nub Fabric with Silver Strand
33	Radiant Bronze Sof-Textured Vinyl Bolster and Bronze Striped Nub Fabric with Silver Strand	341	Radiant Turquoise Sof-Textured Vinyl Bolster and Turquoise Striped Nub Fabric with Silver Strand
34	Radiant Turquoise Sof-Textured Vinyl Bolster and Turquoise Striped Nub Fabric with Silver Strand	371	Radiant Colonial White Sof-Textured Vinyl Bolster and Geranium Striped Nub Fabric with Silver Strand
37	Radiant Colonial White Sof-Textured Vinyl Bolster and Geranium Striped Nub Fabric with Silver Strand	381	Radiant Gold Sof-Textured Vinyl Bolster and Raven Striped Nub Fabric with Silver Strand
38	Radiant Gold Sof-Textured Vinyl Bolster and Raven Striped Nub Fabric with Silver Strand	571	Radiant Colonial White Sof-Textured Vinyl Bolster and Torch Red Striped Nub Fabric with Silver Strand
39	Radiant Blue Sof-Textured Vinyl Bolster and Blue Shantung Pattern Vinyl	THUNDERBIRD	
40	Radiant Green Sof-Textured Vinyl Bolster and Green Shantung Pattern Vinyl	1X	Blue Sof-Textured Vinyl Bolster and Blue Nylon Check Fabric with Silver Strand
45	Radiant Green-Sof Textured Vinyl Bolster and Green Thong Pattern Plasti-Fab Weave with Gold Strand	2X	Green Sof-Textured Vinyl Bolster and Green Nylon Check Fabric with Silver Strand
46	Radiant Colonial White Sof-Textured Vinyl Bolster & Red Thong Pattern Plasti-Fab Weave with Gold Strand	3X	Turquoise Sof-Textured Vinyl Bolster and Turquoise Nylon Check Fabric with Silver Strand
47	Radiant Bronze Sof-Textured Vinyl Bolster and Bronze Shantung Pattern Vinyl	4X	Raven Sof-Textured Vinyl Bolster and Raven and White Nylon Check Fabric with Silver Strand
48	Radiant Geranium Sof-Textured Vinyl Bolster and Raven Striped Nub Fabric with Silver Strand	5X	Blue Sof-Textured Vinyl Bolster and Blue Sof-Textured Vinyl
49	Radiant Blue Sof-Textured Vinyl Bolster and Radiant Blue Pleated Sof-Textured Vinyl	6X	Green Sof-Textured Vinyl Bolster and Colonial White Sof-Textured Vinyl
51	Radiant Turquoise Sof-Textured Vinyl Bolster and Radiant Turquoise Pleated Sof-Textured Vinyl	7X	Turquoise Sof-Textured Vinyl Bolster and Colonial White Sof-Textured Vinyl
52	Radiant Gold Sof-Textured Vinyl Bolster and Raven Pleated Sof-Textured Vinyl	8X	Raven Sof-Textured Vinyl Bolster and Colonial White Sof-Textured Vinyl
53	Radiant Geranium Sof-Textured Vinyl Bolster and Raven Pleated Sof-Textured Vinyl	9X	Torch Red Sof-Textured Vinyl Bolster and Colonial White Sof-Textured Vinyl
55	Torch Red Sof-Textured Vinyl Bolster and Raven Pleated Sof-Textured Vinyl	1Y	Raven Genuine Top Grain Leather
56	Torch Red Sof-Textured Vinyl Bolster and Raven Striped Nub Fabric with Silver Strand	2Y	Hickory Tan Genuine Top Grain Leather
		3Y	Turquoise Genuine Top Grain Leather
		4Y	Torch Red Genuine Top Grain Leather
		5Y	Hickory Tan Sof-Textured Vinyl Bolster and Colonial White Sof-Textured Vinyl



Click Here To Order

BUY IT NOW!



PATENT PLATE - CONTINUE

EXTERIOR PAINT BODY COLOR CODES - S

CODE	PART NUMBER	COLOR	CODE	PART NUMBER	COLOR
1952					
A	M-1724	Raven Black	J	M-14200	Hawaiian Bronze
B	M-14285	Sheridan Blue	K	M-2J-16	Sandpiper Tan
C	M-14448	Alpine Blue	L	M-2J-68	Sungate Ivory
D	M-2J-64	Woodsmoke Gray	M	M-1722	Coral Flame Red
E	M-2J-65	Shannon Green Metallic	N	M-14283	Meadow Green
F	M-2J-67	Meadowbrook Green	P		Prime
G	M-2J-66	Glenmist Green	SS		Special Paints
H	M-2J-43	Carnival Red			

1953					
A	M-1724	Raven Black	J	M-2J-188	Polynesian Bronze Metallic
B	M-14285	Sheridan Blue	K	M-2J-16	Sandpiper Tan
C	M-2J-184	Glacier Blue	L	M-2J-68	Sungate Ivory
D	M-2J-64	Woodsmoke Gray	M	M-2J-175	Coral Flame Red (Non-Bleeding)
E	M-2J-185	Timberline Green Metallic		M-1722	Coral Flame Red (Special)
F	M-2J-186	Fernmist Green	P	M-4415	Prime
G	M-2J-187	Seafoam Green	S	M-2J-221	Flamingo Red
H	M-2J-43	Carnival Red Metallic	SS		Special Paints

1954					
A	M-1724	Raven Black	J	M-2J-259	Lancer Maroon Metallic
B	M-14285	Sheridan Blue	L	M-2J-261	Sandalwood Tan
C	M-2J-253	Cadet Blue Metallic	M	M-2J-273	Sandstone White
D	M-2J-184	Glacier Blue	N	M-2J-175	Torch Red
E	M-2J-238	Dovetone Gray	R	M-2J-263	Cameo Coral
F	M-2J-256	Highland Green Metallic	P	M-4415	Prime
G	M-2J-257	Killarney Green Metallic	SS		Special Paints
H	M-2J-258	Sea Haze Green	V	M-2J-358	Golden Rod Yellow

1955					
A	M-1724	Raven Black	K	M-2J-357	Buckskin Brown
B	M-2J-346	Banner Blue	M	M-2J-353	Regency Purple
C	M-2J-347	Aquatone Blue	R	M-2J-175	Torch Red
D	M-2J-355	Waterfall Blue	T	M-2J-359	Thunderbird Blue (Skyhaze Green)
E	M-2J-354	Snowshoe White	V	M-2J-358	Goldenrod Yellow
F	M-2J-348	Pine Tree Green	W	M-2J-352	Tropical Rose
G	M-2J-349	Sea Sprite Green	P		Prime
H	M-2J-350	Neptune Green	S		Special

FORD CAR PARTS



PATENT PLATE - CONTINUE!

EXTERIOR PAINT BODY COLOR CODES - So

Click Here To Order

BUY IT NOW!



CODE	PART NUMBER	COLOR	CODE	PART NUMBER	COLOR
1956					
A	M-1724	Raven Black	J	M-2J-528	Buckskin Tan
B	M-2J-521	Nocturne Blue	K	M-2J-530	Fiesta Red
C	M-2J-529	Bermuda Blue	L	M-2J-534	Peacock Blue
D	M-2J-523	Diamond Blue	M	M-2J-531	Goldenglow Yellow
E	M-2J-524	Colonial White	N	M-2J-533	Mandarin Orange
F	M-2J-525	Pine Ridge Green	P		Prime
G	M-2J-527	Meadowmist Green	S		Special
H	M-2J-532	Platinum Gray			

1957					
A	M-1724	Raven Black	P		Prime
C	M-1J-834	Dresden Blue	Q	M-1J-706	Thunderbird Bronze
E	M-2J-524	Colonial White	S		Special
F	M-1J-633	Starmist Blue	T	M-1J-756	Woodsmoke Gray
G	M-1J-755	Cumberland Green	V	M-1J-640	Flame Red
J	M-1J-747	Willow Green	X	M-1J-835	Dusk Rose
K	M-1J-841	Dark Brown (Special)	Y	M-1J-641	Inca Gold
L	M-1J-748	Doeskin Tan	Z	M-1J-642	Coral Sand
N	M-1J-757	Gunmetal Gray			
D	M-1J-871	Silver Mocha			

1958					
A	M-1724	Raven Black	M	M-1J-900	Gulfstream Blue
B	M-1J-495	Winterset White	N	M-1J-894	Seaspray Green
C	M-1J-896	Desert Beige	O	M-1J-979	Platinum
D	M-1J-902	Palomino Tan	P		Prime
E	M-2J-524	Colonial White	R	M-2J-175	Torch Red
F	M-1J-893	Silvertone Green	S		Special
G	M-1J-899	Sun Gold	T	M-1J-891	Silvertone Blue
H	M-1J-897	Gunmetal Gray	V	M-1J-859	Casino Cream
I	M-1J-1026	Grenadier Red	W	M-1J-860	Cameo Rose
J	M-1J-895	Bali Bronze	X	M-1J-857	Cascade Green
K	M-1J-856	Everglade Green	Y	M-1J-853	Monarch Blue
L	M-1J-892	Azure Blue	Z	M-1J-854	Regatta Blue

1959					
PASSENGER			THUNDERBIRD		
A	M-1J-1724	Raven Black	A	M-1J-1724	Raven Black
C	M-1J-1012	Wedgewood Blue	C	M-1J-1168	Baltic Blue
D	M-1J-1019	Indian Turquoise	D	M-1J-1019	Indian Turquoise
E	M-1J-524	Colonial White	E	M-1J-524	Colonial White
F	M-1J-1016	Fawn Tan	F	M-1J-1068	Hickory Tan
G	M-1J-1014	April Green	G	M-1J-1066	Glacier Green
H	M-1J-1015	Tahitian Bronze	H	M-1J-1015	Tahitian Bronze
J	M-1J-1011	Surf Blue	J	M-1J-1061	Steel Blue
Q	M-1J-1013	Sherwood Green	K	M-1J-1073	Sandstone
R	M-1J-175	Torch Red	L	M-1J-921	Diamond Blue
T	M-1J-1018	Geranium	M	M-1J-1067	Doeskin Beige
Y	M-1J-641	Inca Gold	N	M-1J-1167	Starlight Blue
Z	M-1J-1206	Gunsmoke Gray	Q	M-1J-1065	Sea Reef Green
P		Prime	R	M-1J-1216	Brandywine Red
S		Special	T	M-1J-1071	Flamingo
L	M-1J-1284	Surf Blue	U	M-1J-1172	Cordovan
M	M-1J-1285	Sherwood Green	V	M-1J-859	Casino Cream
K	M-1J-1286	Tahitian Bronze	W	M-1J-1169	Tamarack Green
N	M-1J-1287	Gunsmoke Gray	Z	M-1J-979	Platinum
1	DL60-1232	Monte Carlo Red			
4	DL60-1273	Meadowvale Green			
5	DL60-1225	Belmont Blue			
6	DL60-1226	Skymist Blue			
W	DL60-1274	Adriatic Green			

1949

Click Here To Order

BUY IT NOW!

100% GUARANTEED SATISFACTION

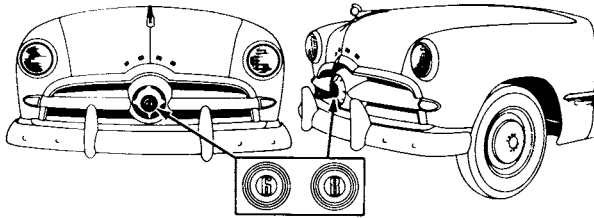

FORD

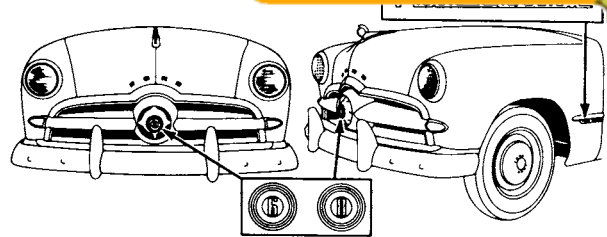

FORD CUSTOM

P-847

1950

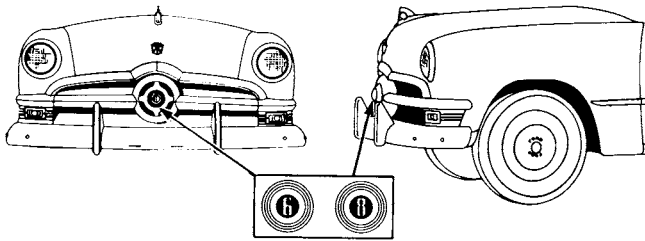

DELUXE

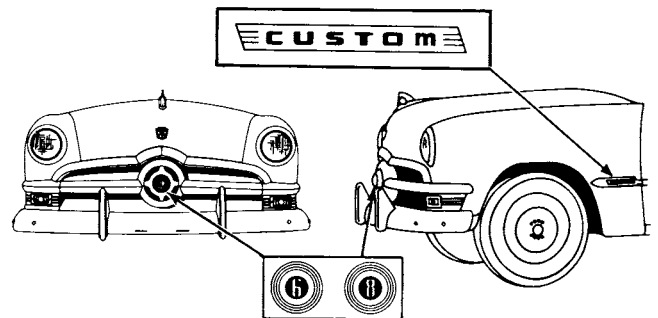

CUSTOM DELUXE

P-1076

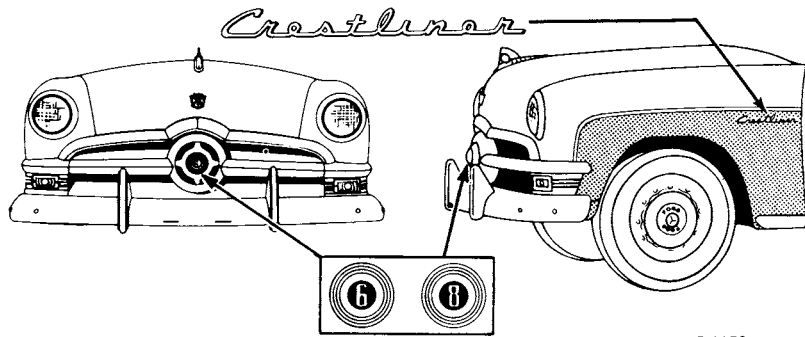

CRESTLINER

P-1152

1951

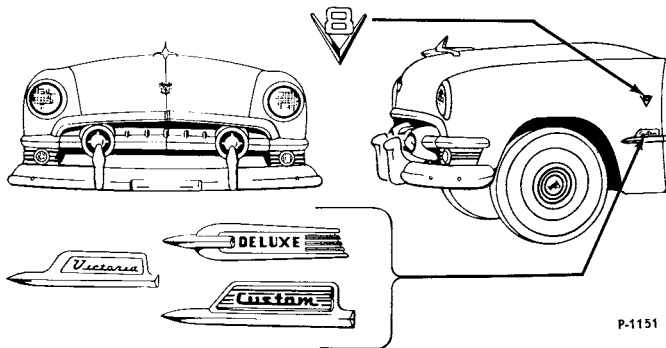

DELUXE, CUSTOM and VICTORIA

P-1151

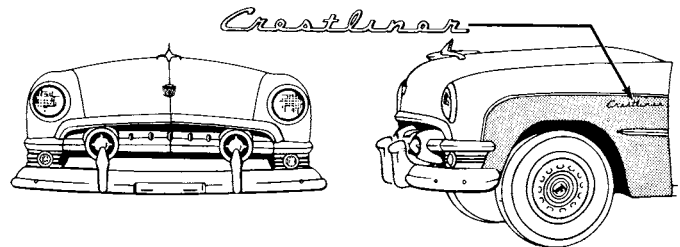

CRESTLINER

P-1187

FORD CAR PARTS

1952

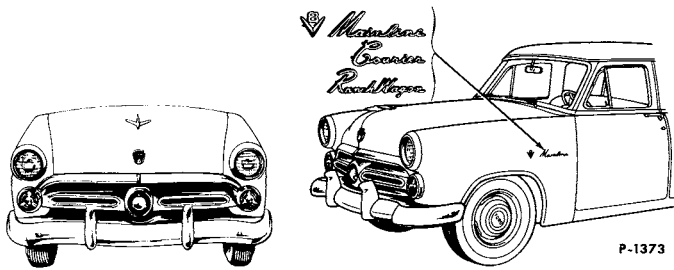

P-1373

MAINLINE AND SEDAN DELIVERY

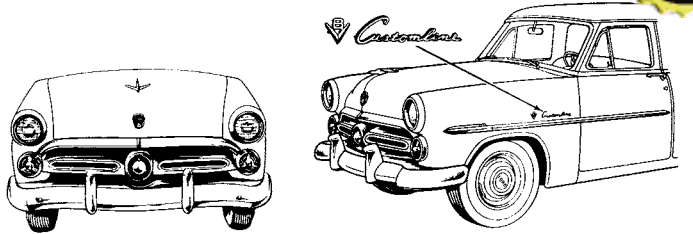

P-1372

CUSTOMLINE

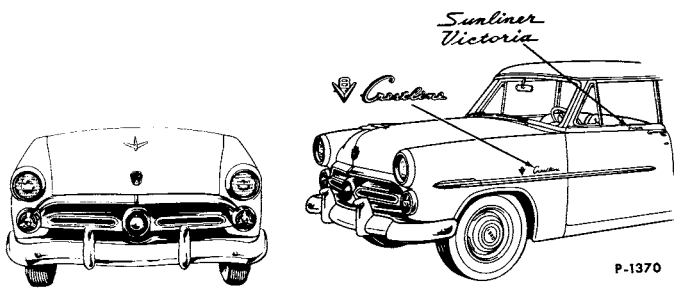

P-1370

CRESTLINE -- VICTORIA AND SUNLINER

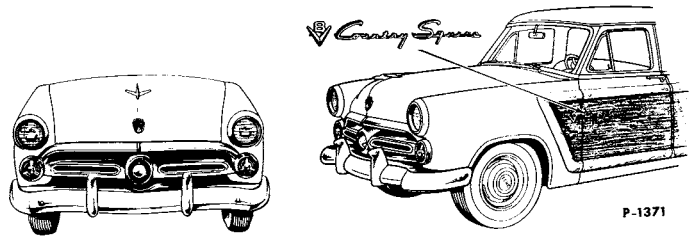

P-1371

CRESTLINE -- COUNTRY SQUIRE

1953

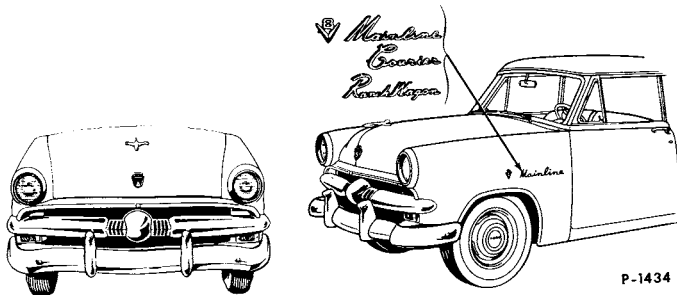

P-1434

MAINLINE AND SEDAN DELIVERY

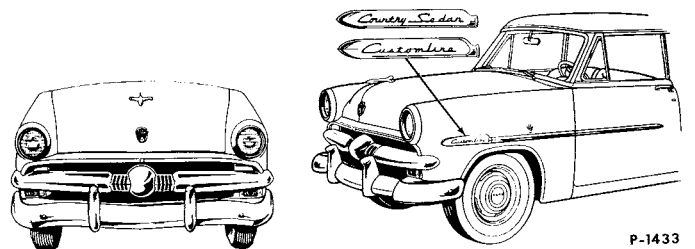

P-1433

CUSTOMLINE

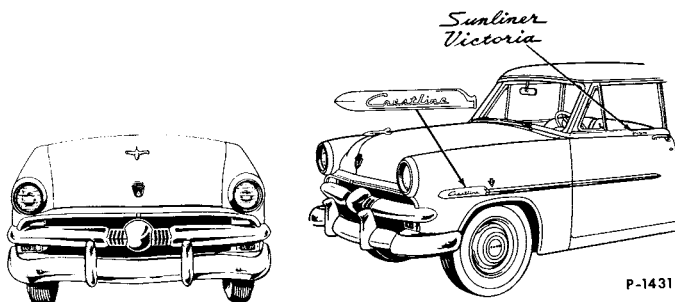

P-1431

CRESTLINE -- VICTORIA AND SUNLINER

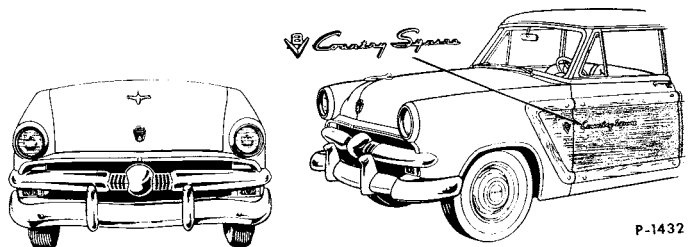

P-1432

CRESTLINE -- COUNTRY SQUIRE

Click Here To Order

BUY IT NOW!

100% GUARANTEED SATISFACTION

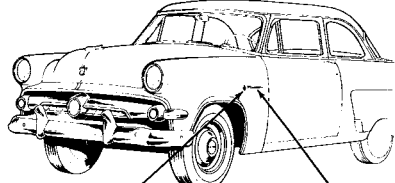
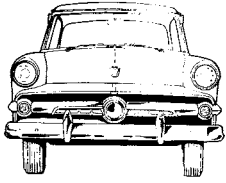

MAINLINE

P-1667

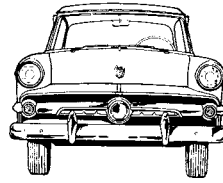

CUSTOMLINE

P-1668

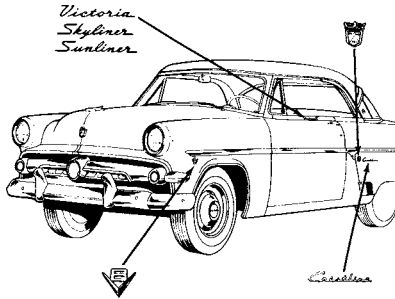
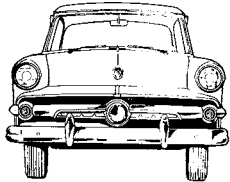

P-1669

CRESTLINE -- VICTORIA, SKYLINER AND SUNLINER

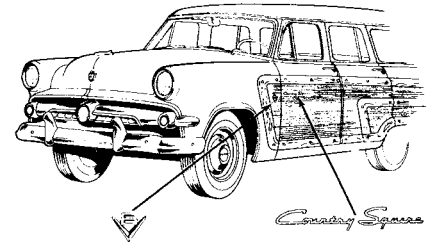
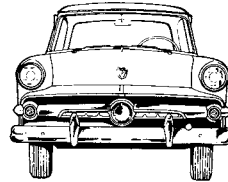

P-1670

CRESTLINE -- COUNTRY SQUIRE

1955

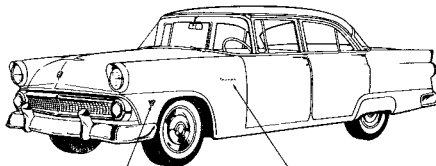
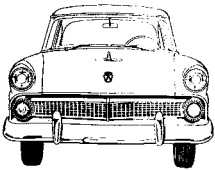

MAINLINE

P-1880

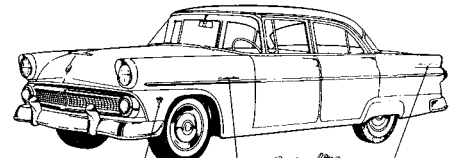
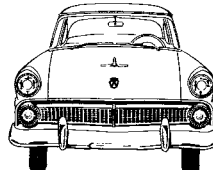

CUSTOMLINE

P-1881

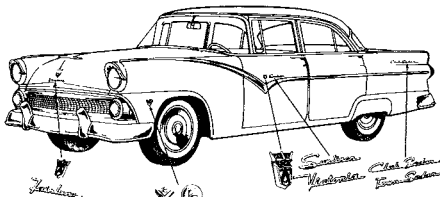

P-1882

FAIRLANE -- VICTORIA AND SUNLINER

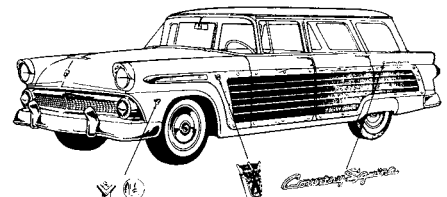
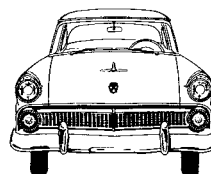

COUNTRY SQUIRE

P-1883

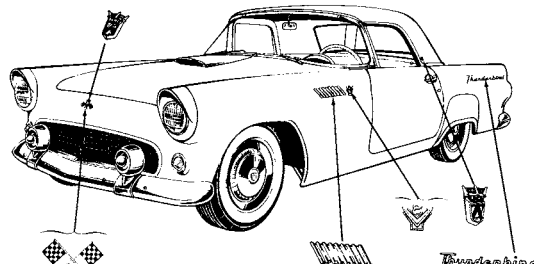
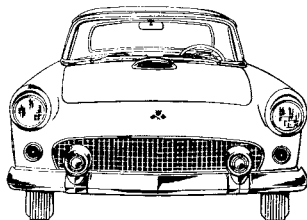

P-2006

FORD THUNDERBIRD

FORD CAR PARTS

1956



Click Here To Order
BUY IT NOW!
100% GUARANTEED

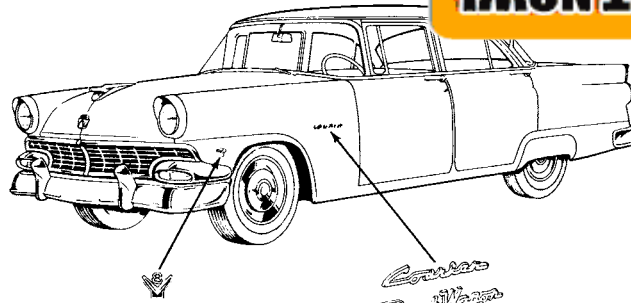
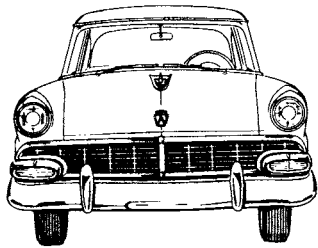

P-1999

MAINLINE

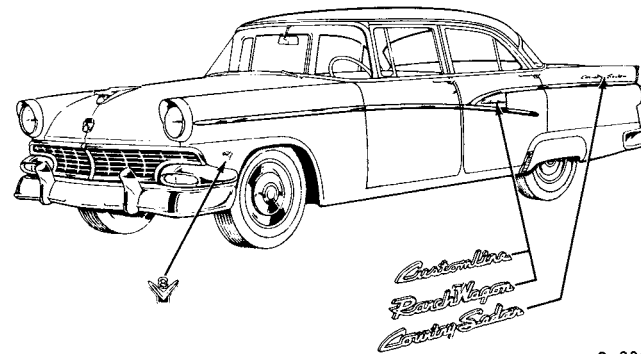
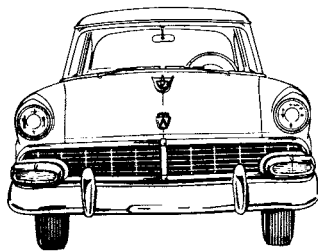

P-2000

CUSTOMLINE

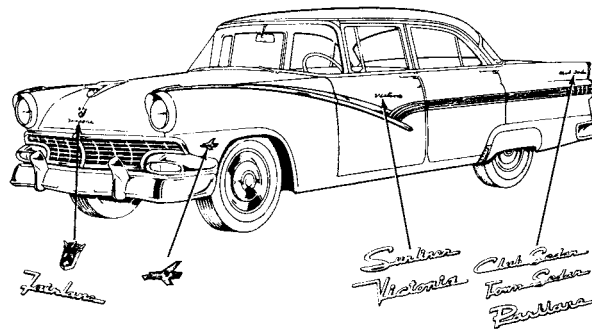
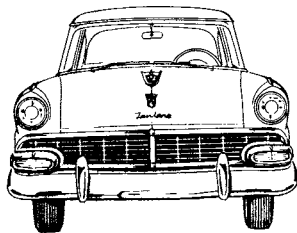

P-2001

FAIRLANE -- VICTORIA AND SUNLINER

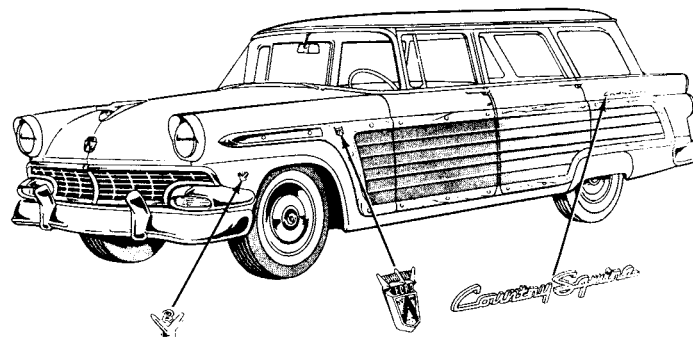
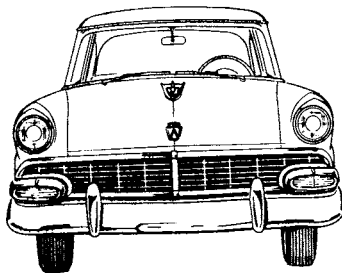

P-2002

COUNTRY SQUIRE

* FAIRLANE SERIES

Click Here To Order

BUY IT NOW!

100% GUARANTEED

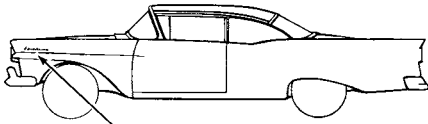

Fairlane

P-2272

FAIRLANE

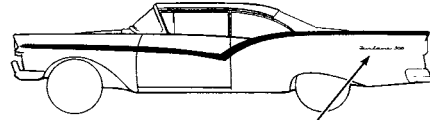

Fairlane 500

P-2274

FAIRLANE "500"

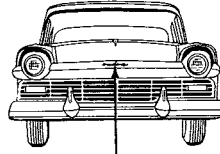

Fairlane

P-2271

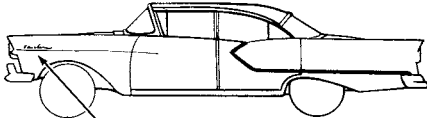

Fairlane

P-2273

FAIRLANE -- UNIQUE TWO-TONE

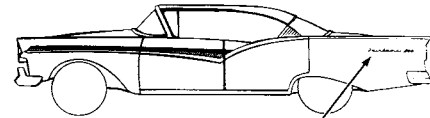

Fairlane 500

P-2275

FAIRLANE "500" -- UNIQUE TWO-TONE

* CUSTOM SERIES

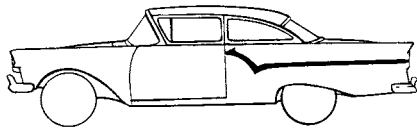

P-2267

CUSTOM

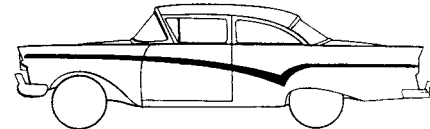

P-2269

CUSTOM "300"

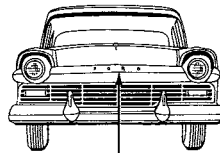

FORD

P-2266

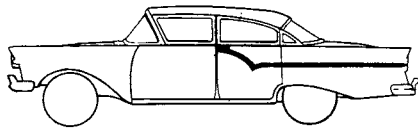

P-2268

CUSTOM -- UNIQUE TWO-TONE

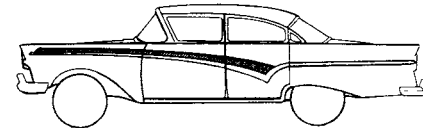

P-2270

CUSTOM "300" -- UNIQUE TWO-TONE

* STATION WAGONS, ETC.

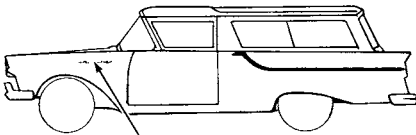

Ranch Wagon

P-2276

CUSTOM -- RANCH WAGON

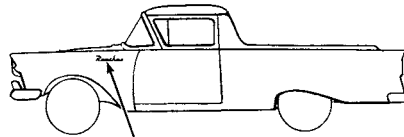

Ranchero

P-2278

CUSTOM -- RANCHERO

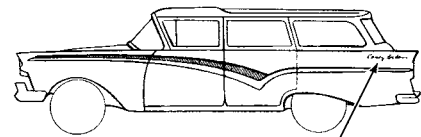

Country Sedan

P-2279

COUNTRY SEDAN
FAIRLANE "500" -- UNIQUE TWO-TONE

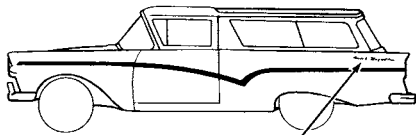

Ranch Wagon

P-2277

RANCH WAGON
CUSTOM "300" -- UNIQUE TWO-TONE

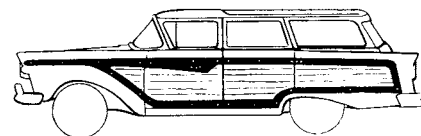

P-2280

COUNTRY SQUIRE
FAIRLANE "500" -- UNIQUE TWO-TONE

* Does not include all body types. Illustrations are representative models.

FORD CAR PARTS

1958



* FAIRLANE SERIES

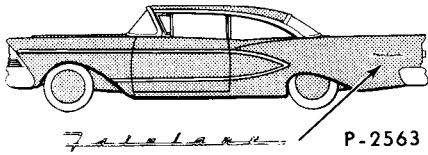

P-2563

FAIRLANE

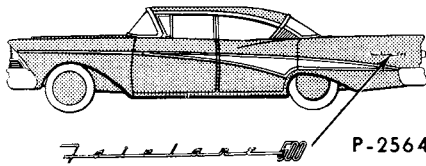

P-2564

FAIRLANE "500"

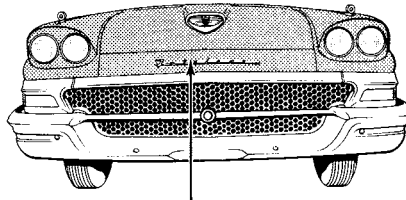

P-2565

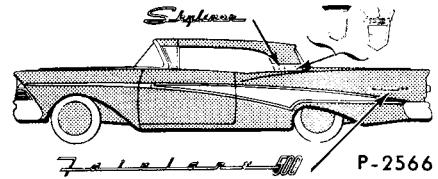

P-2566

**FAIRLANE "500"
HIDE-AWAY HARDTOP**

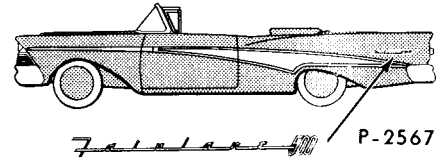

P-2567

FAIRLANE "500" CONVERTIBLE

* CUSTOM SERIES

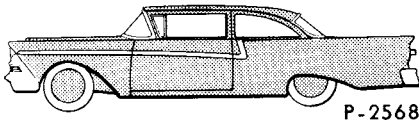

P-2568

CUSTOM "300" - SPECIAL

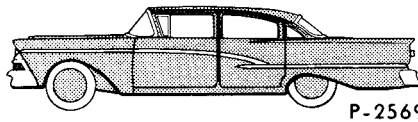

P-2569

CUSTOM "300"

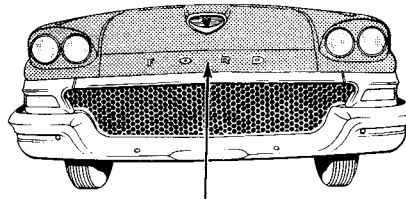

P-2570

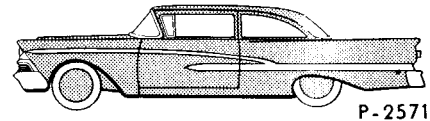

P-2571

CUSTOM "300" STYLETONE

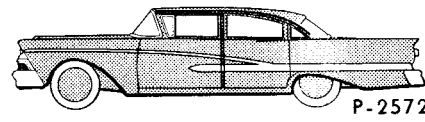

P-2572

CUSTOM "300" STYLETONE

* STATION WAGONS, ETC.

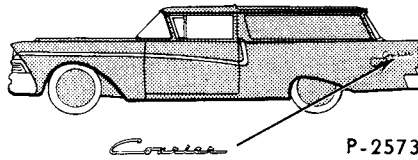

P-2573

CUSTOM-COURIER

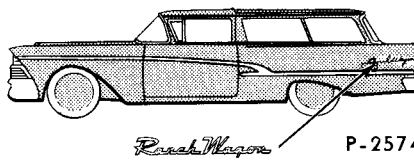

P-2574

CUSTOM "300" RANCH WAGON

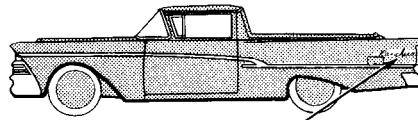

P-2577

CUSTOM "300" RANCHERO

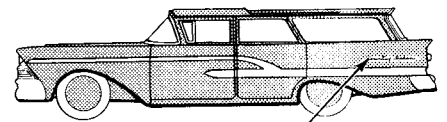

P-2575

**CUSTOM "300" STYLETONE
COUNTRY SEDAN**

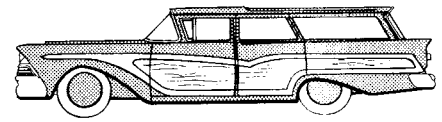

P-2576

FAIRLANE "500" COUNTRY SQUIRE

*Does not include all body types. Illustrations are representative models.

FORD CAR PARTS 1959

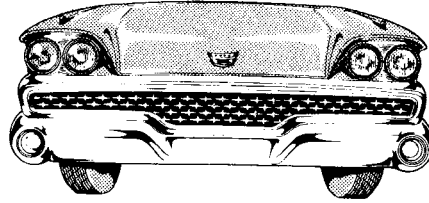

* FAIRLANE SERIES

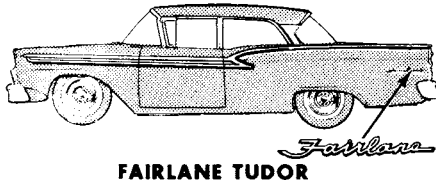

FAIRLANE TUDOR

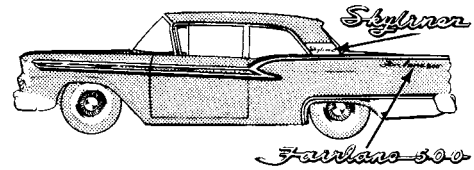

FAIRLANE "500" HIDE-AWAY HARDTOP-SKYLINER

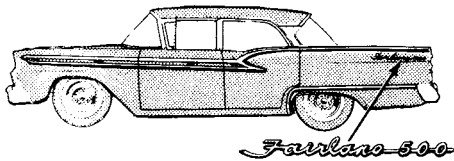

FAIRLANE "500" FORDOR

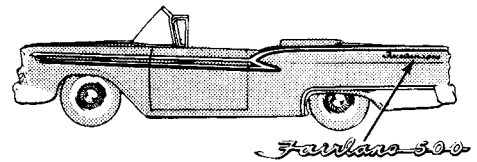

FAIRLANE "500" CONVERTIBLE-SUNLINER

* CUSTOM "300" SERIES

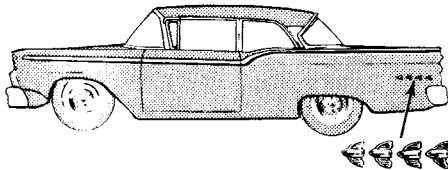

CUSTOM "300" TUDOR

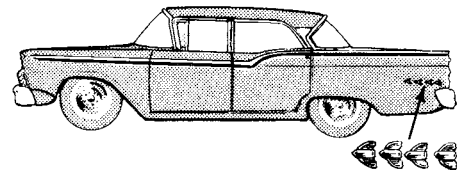

CUSTOM "300" FORDOR

* STATION WAGONS, ETC.

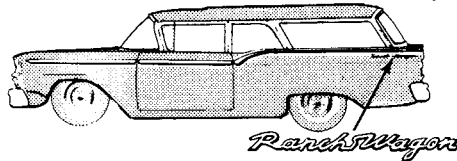

TUDOR CUSTOM "300"
RANCH WAGON

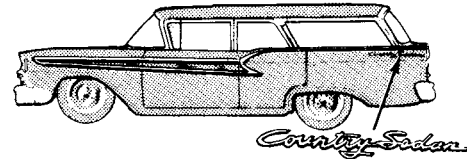

FAIRLANE "500"
FORDOR RANCH WAGON
COUNTRY SEDAN

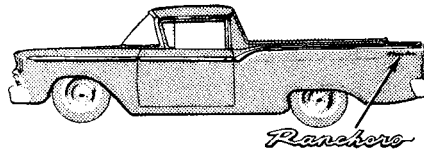

CUSTOM "300"
RANCHERO

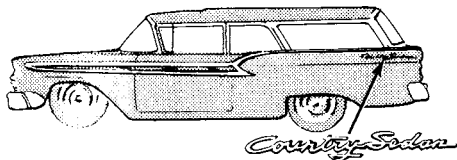

FAIRLANE "500"
TUDOR RANCH WAGON-COUNTRY SEDAN

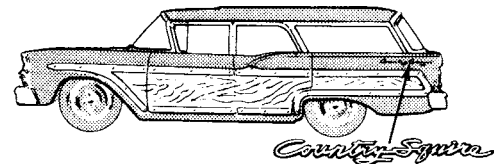

FAIRLANE "500"
COUNTRY SQUIRE

* Does not include all body types. Illustrations are representative models

FORD CAR PARTS



INDEX

YEAR	TITLE			
1949	Instrument Panel	P-859		
1950	Instrument Panel	P-1070	106	367
1950	Instrument Panel Cluster	P-1115	106	368
1951	Instrument Panel and Related Parts (Ford)	P-1235	Misc.	2
1952	Instrument Panel and Related Parts (Ford)	P-1315	Misc.	4
1953	Instrument Panel and Related Parts (Ford)	P-1450	Misc.	6
1954	Instrument Panel and Related Parts (Ford)	P-1628	Misc.	8
1955	Instrument Panel and Related Parts (Ford)	P-1825	Misc.	10
1956	Instrument Panel and Related Parts (Ford)	P-1932	Misc.	14
1957	Instrument Panel and Related Parts (Ford)	P-2226	Misc.	16
1958	Instrument Panel and Related Parts (Ford)	P-2481	Misc.	20
1959	Instrument Panel and Related Parts (Ford)	P-2797	Misc.	24
1955/56	Instrument Panel and Related Parts (Thunderbird)	P-1717	Misc.	12
1957	Instrument Panel and Related Parts (Thunderbird)	P-2379	Misc.	18
1958	Instrument Panel and Related Parts (Thunderbird)	P-2651	Misc.	22
1959	Instrument Panel and Related Parts (Thunderbird)	P-2651	Misc.	26

FORD CAR PARTS



Click Here To Order

BUY IT NOW!

100% GUARANTEED

1951 FORD INSTRUMENT PANEL & RELATED PARTS

Group	Part Number	Part Name	Group	Part Number	Part Name
3678	★1A 3678-DP	Bracket (steering column)	06069	★1A 7006069	Spring (glove door)
3678	★1A 3678-EP	Bracket (steering column)	06081	1A 7006081-C	Lock (glove door)
9272	★1A 9272-B	Bar (bus)	06117	★1A 7006117-AP	Stop (glove door)
9273	★1A 9273-B	Gauge (oil pressure)	06122	1A 7006122	Grommet (door check)
9280	★1A 9280-B	Gauge (fuel)	10838	★1A 10838-BP	Case & glass (instrument)
9700	★1HA 9700-A	Control (carburetor choke)	10841	★1A 10841-BP	Case only
01891	★1A 7001891-A	Control (air)	10850	1A 10850-C	Ammeter
04320	★1A 7004320-DP	Panel (instrument)	10852	★1A 10852-A	Bezel (windshield wiper)-inner
04332	★1A 7004332-AB	Moulding-R. H. -aluminum	10852	★1A 10852-B	Bezel (exterior lights)
04332	★1A 7004332-BZ6	Moulding-R. H. -chrome	10852	★1A 10852-C	Bezel (interior lights)-inner
04333	★1A 7004333-AB	Moulding-L. H. -aluminum	10852	★1A 10852-D	Bezel (choke)-inner
04333	★1A 7004333-BZ6	Moulding-L. H. -chrome	10853	1A 10853-A	Bezel (controls)-outer
04338	★1A 7004338-AP	Panel (finish)-R. H.	10876	★1A 10876-B	Bezel (instrument cluster)
04339	★1A 7004339-AP	Panel (finish)-L. H.	10880	★1A 10880	Glass (instrument cluster)
04360	★1A 7004360-CB	Cover (button opening)	10883	1A 10883-B	Gauge (temperature)
04370	★1A 7004370-CB	Cover (radio opening)	11572	1A 11572-B	Switch (ignition)
04416	★1A 7004416	Clip (opening cover)	11574	1A 11574-B	Nut (ignition switch bezel)
04428	★1A 7004428	Medallion (clock opening)	11580	B9S 11580-A	Bezel (ignition switch)-inner
04439	★1A 7004439-B	Retainer (moulding)	11581	1A 11581-B	Spring (ignition switch retainer)
04440	★1A 7004440	Clip (clock opening cover)	11582	1A 11582-A	Cylinder & keys (ignition)
04449	★1A 7004449	Bolt (cover)	11654	FAA 11654-A	Switch (light control)
04460	★1A 6004460-A	Plate (radio grille name)	11661	★1A 11661-A	Knob & shaft (light switch)
04460	★1A 7004460-A	Plate (radio grille name)	11662	1A 11662-AZ6	Nut (light switch)
04460	★1A 7004460-B	Plate (radio grille name)	13466	78 13466	Bulb (heater control panel)
04467	★1A 7004467-AB	Plate (steering column finish)	13740	FAA 13740-A	Switch (instrument lamp)
04467	★1A 7004467-BB	Plate (steering column finish)	13752	1A 13752	Switch (dome lamp)
04489	★1A 7004489-CB	Cover (heater control opening)	13753	1A 13753-A	Nut (w/s wiper & dome lamp)
04491	★1A 7004491	Clip (control opening cover)	13755	★1A 13755-A	Knob (ash receptacle heater blower & dome lamp)
04504	★1A 7004504	Moulding (clock opening)	15026	★ FAA 15026-B	Wire & socket (electric clock)
04539	★1A 7004539	Medallion	17255	8A 17255-A	Speedometer
04540	★1A 7004540-A	Retainer (medallion)	17470	1A 17470-A	Control (windshield wiper)
04541	1A 7004541	Pad (medallion)	17513	★1A 17513-A	Knob (windshield wiper control)
04564	★1A 7004564	Plate (medallion mounting)	18518	★1A 18518-A	Control (heater temperature)
04610	★1A 7004610-AZ6	Element & knob (lighter)	18519	★ FAB 18519-B	Knob (temperature control)
04620	★8A 7004620-BZ6	Tube (lighter socket)	18519	★1A 18519-B	Knob (air control)
04646	★1A 7004646-A	Escutcheon (lighter)	18545	★1A 18545	Nut (heater switch)
04648	★1A 7004648	Cover (radio hole)	18548	★ FAA 18548-C	Control (air)
04810	★1A 7004810-B	Receptacle (ash)	18548	★1A 18548-A	Control (defroster)
04826	★1A 7004826	Retainer (ash receptacle)	18549	★1A 18549-A	Panel (heater control)
06010	★1A 7006010-B	Compartment (glove)	18578	★1A 18578-B	Switch (heater blower)
06024	★1A 7006024-AP	Door (glove compartment)	18598	★1A 18598-C	Bezel (heater control)
06064	BA 7006064-B	Catch (door striker plate)	18619	★1A 18619	Plate (control identification)

Used with FORDOMATIC DRIVE

Click Here To Order

BUY IT NOW!

100% GUARANTEED

P-1450

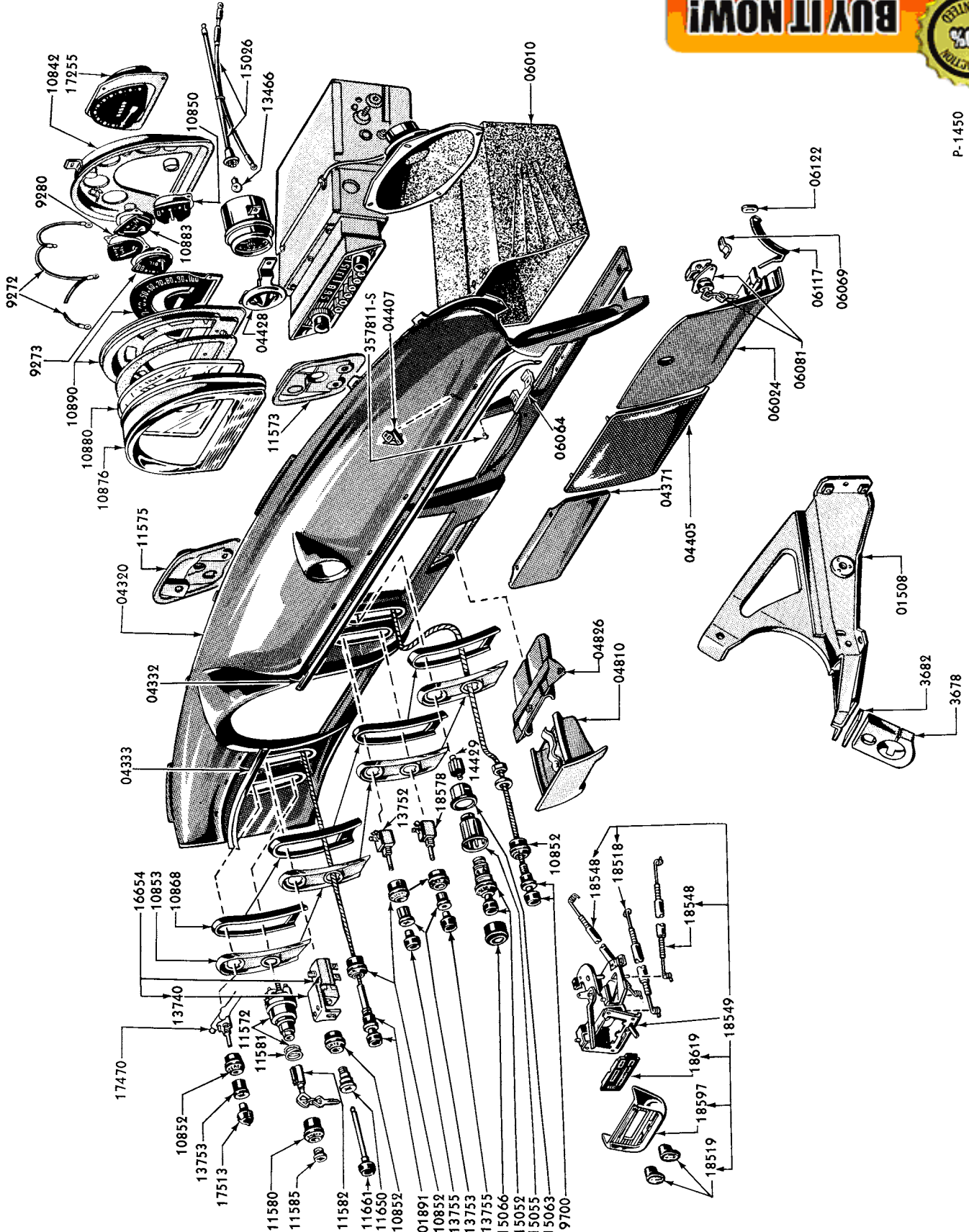

FORD CAR PARTS



1953 FORD INSTRUMENT PANEL & RELATED PARTS

Click Here To Order

BUY IT NOW!

100% SATISFACTION GUARANTEED

Group	Part Number	Part Name	Group	Part Number	Part Name
3678	★AB 3678-AP	Bracket (strg. column)	10876	★FAA 10876-A	Bezel (instr. cluster)
3682	★1A 3682-A	Shim (strg. col. bracket)	10880	★FAA 10880-A	Glass (instr. cluster)
9272	★FAB 9272-A	Wire (inst. cluster)	10883	FAB 10883-C	Gauge (temperature)
9273	FAB 9273-B	Gauge (oil pressure)	10890	★FAD 10890-C	Mask (instr. cluster)
9280	FAB 9280-B	Gauge (fuel)	11572	B5A 11572-A	Switch (ignition)
9700	★FAA 9700-C	Control (carb. choke)	11573	★FAB 11573-A	Plate (controls mtg.)-R. H.
01508	★BR 7001508-B	Support (brake pedal)	11575	★FAB 11575-A	Plate (controls mtg.)-L. H.
01891	FAA 7001891-A	Control (air)	11580	B9S 11580-A	Bezel (ign. switch)-inner
04320	★BF 7004320-AP	Panel (instrument)	11581	1A 11581-B	Spring (ign. switch ret.)
04332	★BF 7004332-A	Moulding-R. H.	11582	B9A 11582-A	Cylinder & keys (ignition)
04333	★BF 7004333-A	Moulding-L. H.	11585	★FAA 11585-A	Retainer (ign. switch bezel)
04371	★BF 7004371-AP	Plate (radio opening)	11650	B2A 11650-A	Nut (light switch)
04405	★BA 7004405-BP	Grille (radio)	11654	FAA 11654-A	Switch (light control)
04407	★BA 7004407-A	Emblem (inst. panel)	11661	★FAB 11661-A	Knob & shaft (light switch)
04428	★1A 7004428-AP	Medallion (clock open)	13466	78 13466	Bulb (clock)
04810	★BA 7004810-AP	Receptacle (ash)	13740	FAA 13740-A	Switch (inst. lamp)
04826	★BA 7004826-A	Retainer (ash receptacle)	13753	1A 13753-A	Nut (w/s wiper, pillar lamp & htr. blower switch)
06010	★BA 7006010-A	Compartment (glove)	13755	FAA 13755-A	Knob assy. (pillar lamp & htr. blower switch)
06024	★BA 7006024-AB	Door (glove compt.)	14429	★FAA 14429-A	Fuse assy. (cigar lighter)
06064	BA 7006064-B	Catch (door striker plate)	15026	FDA 15026-C	Wire & socket assy. (elec. clock & cigar lighter)
06066	★356811-S	Bumper (glove door)	15052	★FAE 15052-A	Knob & element assy. (cigar lighter)
06069	★BA 7006069-A	Spring (glove door)	15055	FAA 15055-E	Socket & retainer assy. (cigar lighter)
06081	BA 7006081-C	Lock (glove door)	15063	★FAA 15063-A	Adapter (cigar lighter)
06117	★BA 7006117-AP	Stop (glove door)	17255	FAE 17255-C	Speedometer assy.
06122	IA 7006122	Grommet (glove door)	17470	FAA 17470-A	Control (w/s wiper)
10842	★FAA 10842-A	Case (instr. cluster)	17513	FAB 17513-A	Knob (w/s wiper control)
10850	FAC 10850-B	Ammeter	18518	★FAC 18518-A	Control (htr. temp.)
10852	★FAA 10852-A	Bezel (w/s wiper)-inner	18519	★FAB 18519-B	Knob (temp. control)
10852	★FAA 10852-B	Bezel (ext. lights)-inner	18548	B5A 18548-A	Control (air)
10852	★FAA 10852-C	Bezel (int. lights)-inner	18548	FAA 18548-D	Control (defroster)
10852	★FAA 10852-D	Bezel (choke)-inner	18549	B3A 18549-A	Panel (htr. control)
10852	★FAA 10852-E	Bezel (air control)-inner	18578	FAA 18578-A	Switch (htr. blower)
10852	★FAA 10852-F	Bezel (blower)-inner	18597	★FAA 18597-C	Bracket (controls mtg.)
10853	★FAD 10853-A	Bezel(wiper & ign. switch)-outer	18619	★FAA 18619-A	Plate (control ident.)
10853	★FAD 10853-B	Bezel(exterior lights & air)- <small>OUTER</small>			
10853	★FAD 10853-C	Bezel(interior lights & air)- <small>OUTER</small>			
10853	★FAD 10853-D	Bezel (cigar lighter & choke)- <small>outer</small>			
10868	★FAB 10868-A	Seal (outer bezels)			

