

1959

Ford  
Car  
Shop  
Manual



**100% SATISFACTION GUARANTEED**

**BUY IT NOW!**

**Click Here To Order**

**FORD DIVISION**  
**FORD MOTOR COMPANY**

Copyright © 2010, Forel Publishing Company, LLC, Woodbridge, Virginia

All Rights Reserved. No part of this book may be used or reproduced in any manner whatsoever without written permission of Forel Publishing Company, LLC. For information write to Forel Publishing Company, LLC, 3999 Peregrine Ridge Ct., Woodbridge, VA 22192

## **1959 Ford Car Shop Manual**

**EAN: 978-1-60371-053-4**

**ISBN: 1-60371-053-1**

Forel Publishing Company, LLC

3999 Peregrine Ridge Ct.

Woodbridge, VA 22192

Email address: [webmaster@ForelPublishing.com](mailto:webmaster@ForelPublishing.com)

Website: <http://www.ForelPublishing.com>



This publication contains material that is reproduced and distributed under a license from Ford Motor Company. No further reproduction or distribution of the Ford Motor Company material is allowed without the express written permission of Ford Motor Company.

---

## **Note from the Editor**

This product was created from the original Ford Motor Company's publication. Every effort has been made to use the original scanned images, however, due to the condition of the material; some pages have been modified to remove imperfections.

---

## **Disclaimer**

Although every effort was made to ensure the accuracy of this book, no representations or warranties of any kind are made concerning the accuracy, completeness or suitability of the information, either expressed or implied. As a result, the information contained within this book should be used as general information only. The author and Forel Publishing Company, LLC shall have neither liability nor responsibility to any person or entity with respect to any loss or damage caused, or alleged to be caused, directly or indirectly by the information contained in this book. Further, the publisher and author are not engaged in rendering legal or other professional services. If legal, mechanical, electrical, or other expert assistance is required, the professional should be sought.



# 1959

# FORD CAR

# SHOP MANUAL

## INDEX

ENGINES AND EXHAUST SYSTEMS	1
IGNITION SYSTEM	2
FUEL SYSTEM	3
COOLING SYSTEM	4
CLUTCH AND MANUAL-SHIFT TRANSMISSIONS	5
CRUISE-O-MATIC TRANSMISSION	6
FORDOMATIC TRANSMISSION	7
REAR AXLE AND DRIVE LINE	8
WHEELS, TIRES, CHASSIS SUSPENSION, AND FRAMES	9
STEERING	10
BRAKES	11
GENERATING AND STARTING SYSTEMS	12
LIGHTS, INSTRUMENTS, AND ACCESSORIES	13
STATION WAGON, CONVERTIBLE, AND RETRACTABLE HARDTOP BODY FEATURES	14
BODY MAINTENANCE AND REPAIR	15
DOORS, DECK LIDS, LOCKS, AND WINDOWS	16
INTERIOR TRIM, SEATS, FRONT SHEET METAL, AND BUMPERS	17
BODY INSTALLATION DRAWINGS	18
MAINTENANCE, LUBRICATION, AND SPECIAL TOOLS	19
SPECIFICATIONS AT END OF EACH GROUP	



**BUY IT NOW!**

**Click Here To Order**

DEPARTMENT  
DIVISION  
OR COMPANY



OTOR COMPANY, DEARBORN, MICHIGAN

## FOREWORD

*This manual provides information for the proper servicing of 1959*

*Ford Cars, Station Wagons, Courier, and Ranchero. The*

*descriptions and specifications contained in this manual were*

*in effect at the time the manual was approved for printing.*

*The Ford Division of Ford Motor Company reserves the right*

*to discontinue models at any time, or change specifications*

*or design, without notice and without incurring obligation.*

**SERVICE DEPARTMENT  
FORD DIVISION  
FORD MOTOR COMPANY**



# 1959 FORD CAR SHOP MANUAL

## GROUP I

# ENGINES AND EXHAUST SYSTEMS

	PAGE
<b>PART 1-1</b> GENERAL ENGINE SERVICE.....	1-2
<b>PART 1-2</b> MILEAGE MAKER SIX.....	1-25
<b>PART 1-3</b> THUNDERBIRD 292 V-8.....	1-45
<b>PART 1-4</b> THUNDERBIRD 332 AND 352 SPECIAL V-8, AND 352 POLICE SPECIAL V-8.....	1-68
<b>PART 1-5</b> EXHAUST SYSTEMS.....	1-93
..... SPECIFICATIONS.....	1-98



**BUY IT NOW!**

**Click Here To Order**



# PART

## 1-1

# GENERAL ENGINE SERVICE

The following service procedures apply to all engines. The cleaning, inspection, and reconditioning of the various engine component parts apply after the parts have been removed from the engine, or in the case of a complete engine overhaul, after the engine has been disassembled.

For removal, disassembly, assembly, and installation procedures, refer to Parts 1-2, 1-3, and 1-4.

Section	Page	Section	Page	Section	Page
1 Engine Trouble Diagnosis...	1- 2	4 Cleaning, Inspection, and Reconditioning.....	1-13	4 Cleaning, Inspection, and Reconditioning (Cont.)	
2 Tune-Up.....	1- 8	Intake Manifold.....	1-13	Timing Chain.....	1-17
3 Tests and Adjustments (Engine Installed).....	1- 9	Exhaust Manifold.....	1-13	Camshaft and Bearings ..	1-17
Camshaft Lobe Lift.....	1- 9	Valve Rocker Arm Shaft Assembly.....	1-14	Crankshaft.....	1-18
Valve Timing.....	1- 9	Push Rods.....	1-14	Connecting Rods.....	1-18
Valve Lash—Mileage Maker Six and Thunderbird 292 V-8.....	1-10	Cylinder Heads.....	1-14	Pistons, Pins, and Rings .	1-18
Valve Clearance—Thunderbird 332 or 352 Special and 352 Police		Valves.....	1-16	Main and Connecting Rod Bearings.....	1-20
Special V-8.....	1-11	Hydraulic Valve Lifters—Thunderbird 332 or 352 Special and 352 Police		Flywheel—Manual-Shift Transmissions.....	1-23
Manifold Vacuum Test ..	1-12	Special V-8.....	1-17	Cylinder Block.....	1-23
Compression Test.....	1-13			Oil Pan and Oil Pumps ..	1-24

## 1 ENGINE TROUBLE DIAGNOSIS

Poor engine performance can be caused by the need of a general engine tune-up, by gradual wear of engine parts, or by a sudden parts failure. A good trouble diagnosis will indicate the need of a complete engine tune-up, individual adjustments, part(s) replacement or overhaul, or the need of a complete engine overhaul.

Engine performance complaints usually fall under one of the basic headings listed in the "Engine Trouble Diagnosis Guide."

In addition, the "Engine Trouble Diagnosis Guide," lists procedures and checks to be performed to help isolate the cause of the trouble. When a particular trouble can not be traced to a definite cause by a simple check, the possible items that could be at fault are listed in the order of their probable occurrence. Therefore, in most cases, the items should be checked in the order listed. For example, under Poor Acceleration, the ignition system is

listed as a probable cause of the trouble. All the ignition system items that affect acceleration are listed. These items should all be checked before proceeding to the next probable cause listed in the guide.

For the checking procedures and corrections to be made in the various systems, refer to that part of the manual which covers the system in detail. For example, refer to Part 2-1 for ignition system items.

### ENGINE TROUBLE DIAGNOSIS GUIDE

<p><b>ENGINE WILL NOT CRANK</b></p>	<p>The cause of this trouble is usually in the starting system. If the starting system is not at fault, check for a hydrostatic lock or a seized engine. Remove the spark plugs, then attempt to crank the engine with the starter. If the</p>	<p>engine cranks, it indicates that water is leaking into the cylinders. Remove the cylinder head(s) and inspect the gasket(s) and/or head(s) for cracks. Also examine the cylinder block for cracks.</p>
<p><b>ENGINE CRANKS</b></p>	<p>Check the fuel supply. If there is sufficient fuel in the tank, the cause of the trouble probably lies in either the ignition or the fuel system. To determine which system is at fault, remove the ignition wire from one spark plug. Insert a piece of</p>	<p>proper sized metal rod in the insulator so that it protrudes from the insulator. With the ignition on and the starter cranking the engine, hold the end of the rod approximately 3/16 inch from the cylinder block.</p>

## ENGINE TROUBLE DIAGNOSIS GUIDE (Continued)

**ENGINE CRANKS NORMALLY BUT WILL NOT START (Cont'd)****NO SPARK OR A WEAK SPARK AT THE SPARK PLUGS**

The cause of the trouble is in the ignition system.

To determine if the cause of the trouble is in the primary or the secondary circuit, remove the coil high tension lead from the top of the distributor and hold it approximately 3/16 inch from the cylinder head, then with the ignition on and the engine turning over, check for a spark.

If the spark at the coil high tension lead is good, the cause of the trouble is probably in the distributor cap, rotor, or the spark plug wires.

If there is no spark or a weak spark at the coil high tension lead, the cause of the trouble is probably in the primary circuit, coil to distributor high tension lead, or the coil.

**A GOOD SPARK AT THE SPARK PLUGS**

If the spark is good at the spark plugs, check the spark plugs and the ignition timing. If the spark plugs or the ignition timing are not at fault, check the following items.

**MANUAL CHOKE**

Check the choke linkage for binding or damage. Make certain the choke plate closes when the choke knob on the instrument panel is pulled out and that the plate opens when the knob is pushed in.

**AUTOMATIC CHOKE**

Check the position of the choke plate. If the engine is warm, the plate should be open. If the plate is not open, the engine will load up due to the excessively rich mixture and will not start. If the engine is cold, the plate should be closed, if the plate is not operating properly, check the following items:

**FUEL SYSTEM**

Idle fuel mixture needle(s) not properly adjusted.

Engine idle speed set too low.

The choke not operating properly.

Float setting incorrect.

Fuel inlet system not operating properly.

Dirt or water in fuel lines or carburetor.

The choke linkage for binding.

The fast idle cam for binding.

Thermostatic spring housing adjustment.

Fast idle speed screw for proper adjustment.

Choke plate valve for proper operation (Ford carburetors).

**FUEL BOWL VENT SYSTEM**

Check for proper operation of the vent system (Holley dual carburetor).

**FUEL SUPPLY AT CARBURETOR**

Work the throttle by hand several times. Each time the throttle is actuated fuel should spurt from the accelerating pump discharge nozzles.

If fuel is discharged by the accelerating pump, the engine is probably flooded, or there is water in the fuel system, or an engine mechanical item, such as valves, is at fault.

If fuel is not discharged by the accelerating pump, disconnect the carburetor fuel inlet line at the carburetor. Use a suitable container to catch the fuel. Crank the engine to see if fuel is reaching the carburetor.

If fuel is not reaching the carburetor, check:

The fuel pump.

The carburetor fuel inlet line for obstructions.

The flexible fuel pump inlet line for a collapsed condition.

The fuel tank line to flexible fuel line for obstructions.

The fuel tank vent.

If fuel is reaching the carburetor, check:

The fuel inlet system including, the fuel inlet screen, the fuel inlet needle and seat assembly, and the float assembly.

Check for dirt in the carburetor, not allowing fuel to enter or be discharged from the idle system.

**ENGINE**

Check the valve timing.

Carburetor icing.

Fuel pump defective.

**IGNITION SYSTEM**

Breaker points not properly adjusted.

Defective spark plugs.

Open circuit at the resistor.

Leakage in the high tension wiring.

**ENGINE STARTS, BUT  
WILLS TO KEEP RUNNING**



**BUY IT NOW!**

**Click Here To Order**



CONTINUED ON NEXT PAGE

## ENGINE TROUBLE DIAGNOSIS GUIDE (Cont.)

**ENGINE RUNS, BUT MISSES**

Determine if the miss is steady or erratic and at what speed the miss occurs by operating the engine at various speeds under load.

**MISSES STEADILY AT ALL SPEEDS**

Isolate the miss by operating the engine with one cylinder not firing. This is done by operating the engine with the ignition wire removed from one spark plug at a time, until all cylinders have been checked. Ground the spark plug wire removed.

If the engine speed changes when a particular cylinder is shorted out, that cylinder was delivering power before being shorted out. If no change in the engine operation is evident, the miss was caused by that cylinder not delivering power before being shorted out, check the:

**IGNITION SYSTEM**

If the miss is isolated in a particular cylinder, perform a spark test on the ignition lead of the cylinder.

If a good spark does not occur, the trouble is in the secondary circuit of the system, check the:

Spark plug wire.

Distributor cap.

If a good spark occurs, check the spark plug. If the spark plug is not at fault, a mechanical component of the engine is probably at fault.

**ENGINE**

Perform a compression test to determine which mechanical component of the engine is at fault.

**MISSES ERRATICALLY AT ALL SPEEDS****EXHAUST SYSTEM**

Exhaust gas control valve inoperative or sticking.

Exhaust system restricted.

**IGNITION SYSTEM**

Breaker points not properly adjusted.

Defective breaker points, con-

denser, secondary wiring, coil, or spark plugs.

High tension leakage across the coil, rotor, or distributor cap.

**FUEL SYSTEM**

Choke not operating properly.

Float setting incorrect.

Fuel inlet system not operating properly.

Dirt or water in fuel lines or carburetor.

**COOLING SYSTEM**

Check the cooling system for internal leakage and/or for a condition that prevents the engine from reaching normal operating temperature.

**ENGINE**

Perform a compression test to determine which mechanical component of the engine is at fault.

**MISSES AT IDLE ONLY****FUEL SYSTEM**

✓ Idle fuel mixture needles not properly adjusted.

**IGNITION SYSTEM**

Defective coil, condenser, breaker points, rotor, ignition wiring, or spark plugs.

? Excessive play in the distributor shaft.

? Worn distributor cam.

**VACUUM BOOSTER PUMP**

✓ Leaking pump, lines, or fittings.

**ENGINE**

Perform a compression test to determine which mechanical component of the engine is at fault.

**MISSES AT HIGH SPEED ONLY****FUEL SYSTEM**

Power valve clogged or damaged. Low or erratic fuel pump pressure.

Fuel inlet system not operating properly.

**COOLING SYSTEM**

Engine overheating.

**FUEL SYSTEM**

✓ Engine idle speed set too low.

? Idle fuel mixture needle(s) not properly adjusted.

? Float setting incorrect.

✓ Air leaks between the carburetor and the manifold and/or fittings.

? Fuel leakage at the carburetor fuel bowl(s).

**100% SATISFACTION GUARANTEED**

**BUY IT NOW!**

**Click Here To Order**

PayPal   American Express   Discover   MasterCard   VISA

**ENGINE TROUBLE DIAGNOSIS GUIDE (Cont.)**

<p><b>ROUGH ENGINE IDLE (Cont.)</b></p>	<p>Idle fuel system air bleeds or fuel passages restricted.                  Fuel bleeding from the accelerating pump discharge nozzle(s).                  Throttle plate(s) not closing.                  Improper secondary throttle plate stop adjustment (4-barrel carburetor).</p> <p><b>IGNITION SYSTEM</b></p> <p>Improperly adjusted or defective breaker points.                  Fouled or improperly adjusted spark plugs.                  Incorrect ignition timing.                  Spark plug misfiring.</p>	<p><b>EXHAUST SYSTEM</b></p> <p>Exhaust gas control valve inoperative or sticking.</p> <p><b>VACUUM BOOSTER PUMP</b></p> <p>Leaking pump, lines, or fittings.</p> <p><b>ENGINE</b></p> <p>Loose engine mounting bolts or worn insulator.                  Cylinder head bolts not properly tightened.                  Valve lash set too tight (Mileage Maker Six and Thunderbird 292 V-8).</p>
<p><b>POOR ACCELERATION</b></p>	<p><b>IGNITION SYSTEM</b></p> <p>Incorrect ignition timing.                  Fouled or improperly adjusted spark plugs.                  Improperly adjusted or defective breaker points.                  Distributor not advancing properly.</p> <p><b>FUEL SYSTEM</b></p> <p>Inoperative accelerating pump inlet ball check.                  Inoperative accelerating pump discharge ball check.                  Accelerating pump diaphragm defective.                  Float setting incorrect.                  Throttle linkage not properly adjusted.                  Accelerating pump stroke not properly adjusted.</p>	<p>Leaky power valve, gaskets, or accelerating pump diaphragm.                  Dirt or corrosion in accelerating system.                  Distributor vacuum passages in the carburetor blocked.</p> <p><b>EXHAUST SYSTEM</b></p> <p>Exhaust gas control valve inoperative or sticking.</p> <p><b>BRAKES</b></p> <p>Improper adjustment.</p> <p><b>TRANSMISSION</b></p> <p>Clutch slippage (manual - shift transmissions).                  Improper band adjustment (automatic transmissions).</p>
<p><b>ENGINE DOES NOT DEVELOP FULL POWER, OR HAS POOR HIGH SPEED PERFORMANCE</b></p>	<p><b>PRELIMINARY</b></p> <p>Determine if the trouble exists when the engine is cold, at normal operating temperature, or at all engine temperatures.</p> <p><b>ENGINE COLD</b></p> <p><b>EXHAUST SYSTEM</b></p> <p>Exhaust gas control valve inoperative or sticking.</p> <p><b>FUEL SYSTEM</b></p> <p>Clogged or undersize main jets and/or low float setting.                  Clogged or undersize secondary jets (4-barrel carburetor).                  Power valve clogged or damaged.</p>	<p>Secondary throttle plates not opening (4-barrel carburetor).                  Fuel pump pressure incorrect.                  Distributor vacuum passage in the carburetor blocked.</p> <p><b>COOLING SYSTEM</b></p> <p>Thermostat inoperative or incorrect heat range.</p> <p><b>ENGINE AT NORMAL OPERATING TEMPERATURE</b></p> <p><b>EXHAUST SYSTEM</b></p> <p>Exhaust gas control valve inoperative or sticking.</p> <p><b>FUEL SYSTEM</b></p> <p>Same items as for engine cold.</p>

**100% SATISFACTION GUARANTEED**

**BUY IT NOW!**

**Click Here To Order**

PayPal American Express Discover MasterCard VISA

**ENGINE TROUBLE DIAGNOSIS GUIDE (Cont.)**

<p><b>ENGINE DOES NOT DEVELOP FULL POWER, OR HAS POOR HIGH SPEED PERFORMANCE (Cont.)</b></p>	<p><b>ALL ENGINE TEMPERATURES</b></p> <p><b>IGNITION SYSTEM</b></p> <p>Ignition timing not properly adjusted.</p> <p>Defective coil, condenser, or rotor.</p> <p>Distributor not advancing properly.</p> <p>Excessive play in the distributor shaft.</p> <p>Distributor cam worn.</p> <p>Fouled or improperly adjusted spark plugs or spark plugs of improper heat range.</p> <p>Improperly adjusted or defective breaker points.</p> <p><b>FUEL SYSTEM</b></p> <p>Restricted air cleaner.</p> <p>Same items as for engine cold.</p>	<p><b>ENGINE</b></p> <p>Perform an engine compression test to determine which mechanical component is at fault.</p> <p>One or more camshaft lobes worn beyond wear limit.</p> <p>Improper valve timing.</p> <p><b>EXHAUST SYSTEM</b></p> <p>Restriction in system.</p> <p><b>TRANSMISSION</b></p> <p>Improper band adjustment (automatic transmissions).</p> <p><b>BRAKES</b></p> <p>Improper adjustment.</p> <p><b>TIRES</b></p> <p>Improper pressure.</p>
<p><b>EXCESSIVE FUEL CONSUMPTION</b></p>	<p>Determine the actual fuel consumption with test equipment installed in the car.</p> <p>If the test indicates that the fuel consumption is not excessive, demonstrate to the owner how improper driving habits will affect fuel consumption.</p> <p>If the test indicates that the fuel consumption is excessive, make a preliminary check of the following items before proceeding to the fuel and ignition systems.</p> <p><b>PRELIMINARY CHECKS</b></p> <p><b>CHASSIS ITEMS</b></p> <p>Check:</p> <p>Tires for proper pressure.</p> <p>Front wheel alignment.</p> <p>Brake adjustment.</p> <p><b>EXHAUST SYSTEM</b></p> <p>Check the exhaust gas control valve operation.</p> <p><b>ODOMETER</b></p> <p>Check calibration.</p> <p><b>IGNITION SYSTEM</b></p> <p>Check ignition timing.</p> <p><b>FINAL CHECKS</b></p> <p><b>FUEL SYSTEM</b></p> <p>Check:</p> <p>Fuel pump pressure.</p> <p>Engine idle speed.</p>	<p>Idle fuel mixture needle(s) for proper adjustment.</p> <p>Automatic choke for proper operation.</p> <p>Fast idle speed screw for proper adjustment.</p> <p>Accelerating pump stroke adjustment.</p> <p>Anti-stall dashpot for proper adjustment.</p> <p>Air cleaner for restrictions.</p> <p>Float setting or fuel level.</p> <p>Jets for wear and/or damage.</p> <p>Power valve operation.</p> <p>Air bleeds for obstructions.</p> <p>Accelerating pump discharge nozzles for siphoning.</p> <p><b>IGNITION SYSTEM</b></p> <p>Check:</p> <p>Ignition timing.</p> <p>Spark plug condition and adjustment.</p> <p>Distributor spark advance operation.</p> <p><b>ENGINE</b></p> <p>Perform an engine compression test to determine which mechanical component of the engine is at fault.</p> <p><b>COOLING SYSTEM</b></p> <p>Check thermostat operation and heat range.</p> <p><b>TRANSMISSION</b></p> <p>Check band adjustment (automatic transmissions).</p>



**BUY IT NOW!**

**Click Here To Order**



ENGINE TROUBLE DIAGNOSIS GUIDE (Cont.)

<p><b>ENGINE OVERHEATS</b></p>	<p><b>TEMPERATURE SENDING UNIT AND GAUGE</b> Unit or gauge defective, not indicating correct temperature.</p> <p><b>EXHAUST SYSTEM</b> Exhaust gas control valve inoperative or sticking. Restriction in system.</p> <p><b>ENGINE</b> Cylinder head bolts not properly tightened. Incorrect valve lash. Low oil level or incorrect viscosity oil used.</p>	<p><b>COOLING SYSTEM</b> Insufficient coolant. Cooling system leaks. Drive belt tension incorrect. Radiator fins obstructed. Thermostat defective. Cooling system passages blocked. Water pump inoperative.</p> <p><b>IGNITION SYSTEM</b> Incorrect ignition timing.</p> <p><b>BRAKES</b> Dragging brakes.</p>
<p><b>ENGINE FAILS TO REACH NORMAL OPERATING TEMPERATURE</b></p>	<p><b>TEMPERATURE SENDING UNIT AND GAUGE</b> Unit or gauge defective, not indicating correct temperature.</p>	<p><b>COOLING SYSTEM</b> Thermostat inoperative, incorrect heat range, or thermostat not installed.</p>
<p><b>LOSS OF COOLANT</b></p>	<p><b>COOLING SYSTEM</b> Leaking radiator. Loose or damaged hose connections. Water pump leaking. Radiator cap defective. Overheating.</p> <p><b>ENGINE</b> Cylinder head gasket defective.</p>	<p>Intake manifold to cylinder head gasket defective. Improper tightening of cylinder head or intake manifold bolts. Cylinder block core plugs leaking. Temperature sending unit leaking. Cracked cylinder head or block, or warped cylinder head or block gasket surface.</p>
<p><b>NOISY HYDRAULIC VALVE LIFTER</b></p>	<p>A noisy valve lifter can be located by operating the engine at idle speed and placing a finger on the face of the valve spring retainer. If the lifter is not functioning properly, a shock will be felt when the valve seats.</p> <p>Another method of identifying a noisy lifter is by the use of a piece of hose. With the engine operating at idle speed, place one end of the hose near the end of the valve stem and the other end to the ear and listen for a metallic noise. Repeat this procedure on each intake and exhaust valve until the noisy lifter(s) has been located.</p> <p>The most common causes of hydraulic valve lifter troubles are dirt, gum, varnish, carbon deposits, and air bubbles.</p> <p>Dirt in the lifter assembly can prevent the disc valve from seating, or it may become lodged between the plunger and body surfaces. In either case, the lifter becomes inoperative due to failure to "pump-up," or because the internal parts are no</p>	<p>longer free to function properly. When dirt is found to be responsible for lifter malfunction, remove the lifter assembly and thoroughly clean it. Recommended engine oil and filter change intervals should be followed to minimize lifter problems caused by dirt.</p> <p>Deposits of gum and varnish cause similar conditions to exist which may result in lifter malfunction. If these conditions are found to be present, the lifter should be disassembled and cleaned in solvent to remove all traces of deposits.</p> <p>Air bubbles in the lubricating oil, caused by an excessively high or low oil level, may likewise cause lifter malfunction. A damaged oil pick up tube may allow air to be drawn into the lubricating system. To check for the presence of air, remove a valve rocker arm shaft cover and note the condition of the oil as it flows from the valve rocker arm shaft assembly. Perform corrective action as required to remove air from the lubricating oil.</p>

**100% SATISFACTION GUARANTEED**

**BUY IT NOW!**

**Click Here To Order**

PayPal American Express Discover MasterCard VISA

**2 TUNE-UP**

A tune-up is a systematic procedure for testing various engine components, and, if necessary, bringing them within recommended specifications to restore engine efficiency and performance.

The Tune-Up Schedule (Table 1) is applicable for either a minor or major tune-up. A minor tune-up is recommended each 6000 miles and a major tune-up is recommended each 12,000 miles.

The reference after each operation refers to that part of the manual which describes, in detail, the procedure to be followed. Perform the operations in the sequence listed.

**TABLE 1—Tune-Up Schedule**

Operation	Perform on		Recommended Procedure
	Minor	Major	
<b>SPARK PLUGS</b> Clean, adjust, and test.	X	X	Part 2-1
<b>ENGINE COMPRESSION</b> Take compression reading of each cylinder.		X	Part 1-1
<b>INTAKE MANIFOLD</b> Check and tighten bolts.	X*	X	Part 1-2, 1-3 or 1-4
<b>DRIVE BELTS</b> Check and adjust the tension of all drive belts.	X	X	Part 4-1
<b>BATTERY</b> Clean battery cables and terminals.		X	Part 12-1
Tighten cable clamps.		X	
Grease battery terminals.		X	
Check battery state of charge.	X	X	
<b>ELECTRICAL</b> Oil generator rear bearings through oil cup—Mileage Maker Six.		X	Part 12-1
Check generator output.		X	
Check starter motor current draw.		X	
Check coil output.		X	
Perform a primary circuit resistance test.		X	Part 2-1
Perform a secondary circuit continuity test.		X	
<b>DISTRIBUTOR</b> Check the condition of the breaker points.	X		Part 2-1
Replace the breaker points and the condenser.		X	
Check and adjust breaker arm spring tension.		X	
		X	

Operation	Perform on		Recommended Procedure
	Minor	Major	
<b>DISTRIBUTOR (Cont'd)</b> Check and adjust point dwell.		X	Part 2-1
Check and adjust centrifugal advance. (dual advance distributor).		X	
Check and adjust vacuum advance.		X	
Clean distributor cap and rotor.	X	X	
<b>FUEL SYSTEM</b> Clean fuel pump filter bowl.	X	X	Part 3-1
Replace fuel pump filter bowl strainer.		X	
Check fuel pump pressure and capacity.		X	
Clean carburetor fuel bowl(s) and adjust float setting.		X	
<b>ADJUSTMENTS</b> Check and adjust ignition timing.	X	X	Part 2-1
Check and adjust engine idle speed.	X	X	Part 3-1
Adjust idle fuel mixture.	X	X	
Check and adjust valve lash (Mileage Maker Six and Thunderbird 292 V-8).	X	X	Part 1-1
<b>EXHAUST</b> Free the exhaust gas control valve.	X	X	Part 1-5
<b>COOLING SYSTEM</b> Inspect the radiator, hoses, and engine for leaks.		X	Part 4-1
Add rust inhibitor to radiator.		X	

\*On Thunderbird 332 and 352 Special and 352 Police Special V-8 only.

**100% SATISFACTION GUARANTEED**

**BUY IT NOW!**

**Click Here To Order**

PayPal American Express Discover MasterCard VISA

### 3 TESTS AND ADJUSTMENTS (ENGINE INSTALLED)

#### CAMSHAFT LOBE LIFT

1. On the Mileage Maker Six and Thunderbird 292 V-8, loosen the valve rocker arm adjusting screw serving the camshaft lobe to be checked. Slide the valve rocker arm to one side and secure it in this position.

On the Thunderbird 332 and 352 Special and the 352 Police Special V-8 remove the valve rocker arm shaft assembly and install a solid tappet-type push rod in the push rod bore of the camshaft lobe to be checked.

2. Make sure the push rod is in the tappet socket or the lifter push rod cup, then install a dial indicator in such a manner as to have the actuating point of the indicator in the push rod socket and in the same plane as the push rod movement (Fig. 1 or 2).

3. Rotate the crankshaft slowly in the direction of rotation until the tappet or lifter is on the base circle of the camshaft lobe. At this point, the push rod will be in its lowest position. Zero the dial indicator, then continue to rotate the damper slowly until the push rod is in the fully raised position. Compare the total lift recorded on the indicator with specifications.

4. Continue to rotate the crankshaft until the indicator reads zero. This is a check on the accuracy of the original indicator reading.

#### VALVE TIMING

The valve timing should be checked when poor engine performance is noted and **all other checks**, such as carburetion, ignition timing, etc. fail to locate the cause of the trouble.

Before the valve timing is checked, check for a bent timing pointer. Bring the No. 1 piston to T.D.C. on the compression stroke and see if the timing pointer is aligned with the T.D.C. mark on the damper.

If the valve timing is not within specifications, check the timing chain, camshaft sprocket, crankshaft sprocket, camshaft, and crankshaft in the order of accessibility.

To check the valve timing with the engine installed, proceed as follows:

1. Install a quadrant on the crankshaft damper.

On the Mileage Maker Six and Thunderbird 292 V-8, back off the No. 1 intake valve adjusting screw,

then slide the rocker arm to one side and secure it in this position.

On the Thunderbird 332 and 352 Special and the 352 Police Special V-8, remove the right valve rocker arm shaft assembly and remove the No. 1 intake valve push rod (the second push rod) and install a solid tappet-type push rod in its place.

2. Make sure the push rod is in the tappet socket or the lifter push rod cup, then install a dial indicator in such a manner as to have the actuating point of the indicator in the push rod socket and in the same plane as the push rod movement (Fig. 1 or 2).

3. Rotate the crankshaft slowly in the direction of rotation until the tappet or lifter is on the base circle of the camshaft lobe. At this point the push rod will be in its lowest position. Zero the dial indicator and continue rotating the crankshaft slowly in the direction of rotation until the dial indicator registers the specified camshaft lobe lift (Table 2).

4. Compare the crankshaft degrees indicated on the quadrant with specifications (Table 2). After the valve opening is checked, continue to rotate the damper to check the valve closing.

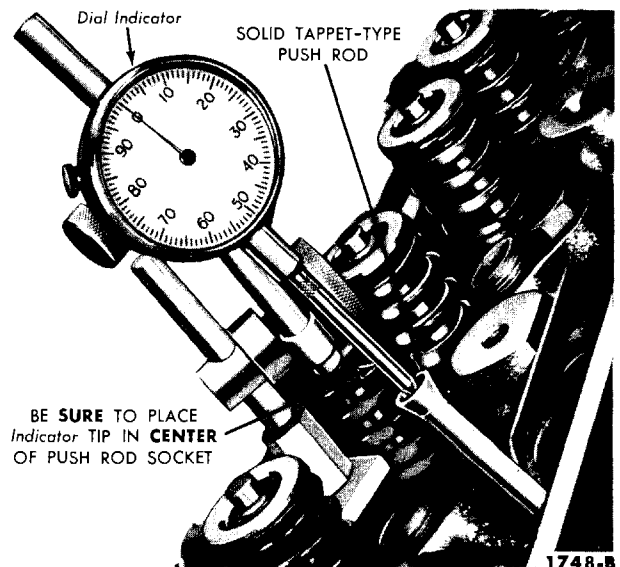

FIG. 2—Camshaft Lobe Lift—Thunderbird 332 or 352 Special and 352 Police Special V-8

**TABLE 2—Valve Timing Specifications**

Engine	Intake Valve				Exhaust Valve			
	Opens		Closes		Opens		Closes	
	Crankshaft Degrees (BTDC)	Camshaft Lobe Lift (Inch)	Crankshaft Degrees (ABDC)	Camshaft Lobe Lift (Inch)	Crankshaft Degrees (BBDC)	Camshaft Lobe Lift (Inch)	Crankshaft Degrees (ATDC)	Camshaft Lobe Lift (Inch)
Mileage Maker Six	17°	0.016	53°	0.019	61°	0.016	9°	0.019
Thunderbird 292 V-8	12°	0.016	54°	0.019	58°	0.015	8°	0.018
Thunderbird 332 Special V-8	17°	0.002	59°	0.005	57°	0.002	19°	0.005
Thunderbird 352 Special and 352 Police Special V-8	22°	0.002	68°	0.005	68°	0.002	22°	0.005

**VALVE LASH—MILEAGE MAKER SIX AND THUNDERBIRD 292 V-8**

Before a final valve lash adjustment is made, operate the engine for 30 minutes at 1200 rpm to stabilize engine temperatures. To accurately set the valve lash, use only a step-type feeler gauge (“go” and “no go”).

It is very important that the valve lash be held to the correct specifications because:

If the lash is set too close, the

valve will open too early and close too late, resulting in rough engine idle. Burning and warping of the valves will occur also because the valves cannot make firm contact with the seats long enough to cool properly. If the lash is excessive, it will cause the valve to open too late and close too early causing valve bounce. In addition, damage to the camshaft lobe is likely because the tappet foot will not follow the pattern of the camshaft lobe causing a shock contact between these two parts.

If the valve rocker arm shaft assembly has been removed and installed, it will be necessary to make a preliminary (cold) valve lash adjustment before starting the engine. If the adjustment is made for an engine tune-up, follow the final adjustment procedure.

On the Mileage Maker Six, the cylinders are numbered from front to rear, 1-2-3-4-5-6 and the valves are arranged from front to rear, E-I-I-E-I-E-E-I-E-I-E.

On the Thunderbird 292 V-8, the cylinders are numbered from front to rear—right bank, 1-2-3-4; left bank, 5-6-7-8. The valves are arranged from front to rear on both banks, E-I-I-E-E-I-I-E.

- STEP 1—SET NO. 1 PISTON ON T.D.C. AT END OF COMPRESSION STROKE ADJUST NO. 1 INTAKE & EXHAUST
- STEP 4—ADJUST NO. 6 INTAKE & EXHAUST

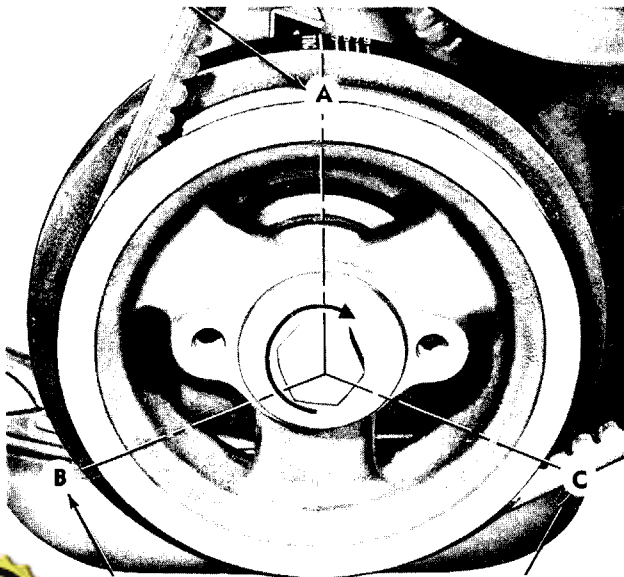

2—ADJUST NO. 5

- STEP 3—ADJUST NO. 3 INTAKE & EXHAUST
- STEP 6—ADJUST NO. 4 INTAKE & EXHAUST

**100% SATISFACTION GUARANTEED**

**BUY IT NOW!**

**Click Here To Order**

PayPal, American Express, Discover, MasterCard, VISA

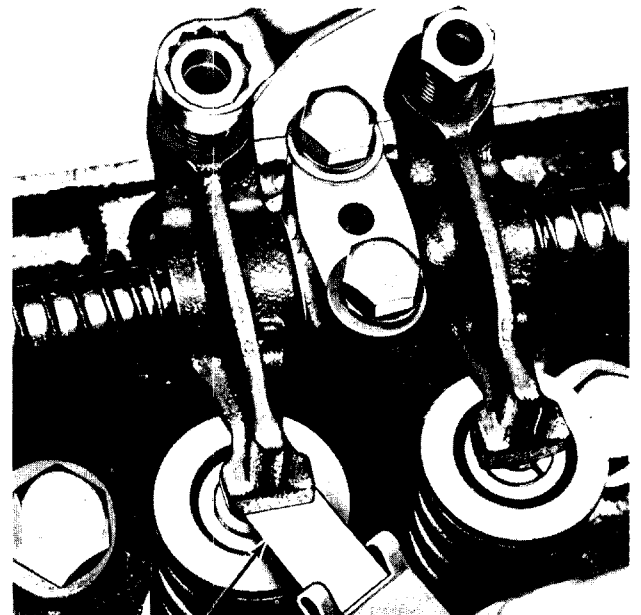

Step-Type Feeler Gauge

1020-A

**FIG. 4—Valve Lash Adjustment—Mileage Maker Six and Thunderbird 292 V-8**

**PRELIMINARY ADJUSTMENT**

First, turn all the valve adjusting screws until interference is noted, then check the torque required to turn the screw further. If the torque required to turn a screw is less than 3 foot-pounds (36 inch-pounds), try a new self locking adjusting screw. If this is still unsatisfactory, replace the rocker arm and adjusting screw.

Next, follow the steps under the applicable engine.

**Mileage Maker Six**

1. Make two chalk marks on the crankshaft damper (Fig. 3). Space the marks approximately 120° apart so that with the timing mark, the damper is divided into three equal parts (120° represents 1/3 of the distance around the damper circumference).

2. Rotate the crankshaft until the No. 1 piston is near T.D.C. at the end of the compression stroke. The No. 1 piston is on T.D.C. at the end of the compression stroke when both valves are closed and the timing mark on the crankshaft damper is in line with the timing pointer.

3. Adjust the intake and exhaust valve lash for No. 1 cylinder (Fig. 4). The preliminary (cold) intake and exhaust valve lash should be set at 0.019 inch.

4. Repeat this procedure for the remaining set of valves, turning the crankshaft 1/3 turn at a time, in the direction of rotation, while adjusting the valves in the firing order sequence (1-5-3-6-2-4).

**Thunderbird 292 V-8**

1. Make three chalk marks on the crankshaft damper (Fig. 5). Space the marks approximately 90° apart so that with the timing mark, the damper is divided into four equal parts (90° represents 1/4 of the distance around the damper circumference). The preliminary (cold) intake and exhaust valve lash should be set at 0.019 inch.

2. Rotate the crankshaft until No. 1 piston is near T.D.C. at the end of the compression stroke, then adjust the following valves:

No. 1 Exhaust	No. 1 Intake
No. 4 Exhaust	No. 2 Intake
No. 5 Exhaust	No. 7 Intake

3. Rotate the crankshaft 180° or ½ turn (this puts No. 4 piston on T.D.C.), then adjust the following valves:

No. 6 Exhaust	No. 4 Intake
No. 8 Exhaust	No. 5 Intake

4. Rotate the crankshaft 270° or ¾ turn from 180° (this puts No. 3 piston on T.D.C.), then adjust the following valves:

No. 2 Exhaust	No. 3 Intake
No. 3 Exhaust	No. 6 Intake
No. 7 Exhaust	No. 8 Intake

**FINAL ADJUSTMENT**

1. Operate the engine for a minimum of **30 minutes at approximately 1200 rpm** to stabilize engine temperatures. **Be sure the engine is at normal operating temperature before attempting to set the valve lash.**

2. With the engine idling, set the valve lash (Fig. 4) using a **step-type feeler gauge only ("go" and "no go")**. The final (hot) intake and exhaust valve lash should be 0.019 inch (Mileage Maker Six) and 0.018 inch (Thunderbird 292 V-8).

To obtain the correct setting on the Mileage Maker Six, use a **step-type feeler gauge** of 0.018 inch ("go") and 0.020 inch ("no go") and on the Thunderbird 292 V-8 use a **step-type feeler gauge** of 0.017 inch ("go") and 0.019 inch ("no go"). The "go" step should enter, and the "no go" step should not enter. The resultant setting will be to the required specification.

**VALVE CLEARANCE—  
THUNDERBIRD 332 OR 352  
SPECIAL AND 352 POLICE  
SPECIAL V-8**

A 0.060-inch shorter push rod is available for service to provide a means of compensating for dimensional changes in the valve mechanism. Valve stem to valve rocker arm clearance should be 0.062-0.1875 inch with the hydraulic lifter completely collapsed. Repeated valve reconditioning operations (valve and/or valve seat re-facing) will decrease this clearance to the point that if not compensated for, the hydraulic valve lifter will cease to function. To determine whether a shorter push rod is necessary, make the following check:

1. **Position the crankshaft as outlined in Steps 2 and 3.** Position the hydraulic lifter compressor tool on the rocker arm and slowly apply pressure to bleed down the hydraulic lifter until the plunger is com-

**STEP 1**—SET NO. 1 PISTON ON T.D.C. AT END OF COMPRESSION STROKE—ADJUST NO. 1, 4, 5 EXHAUST & NO. 1, 2, 7 INTAKE

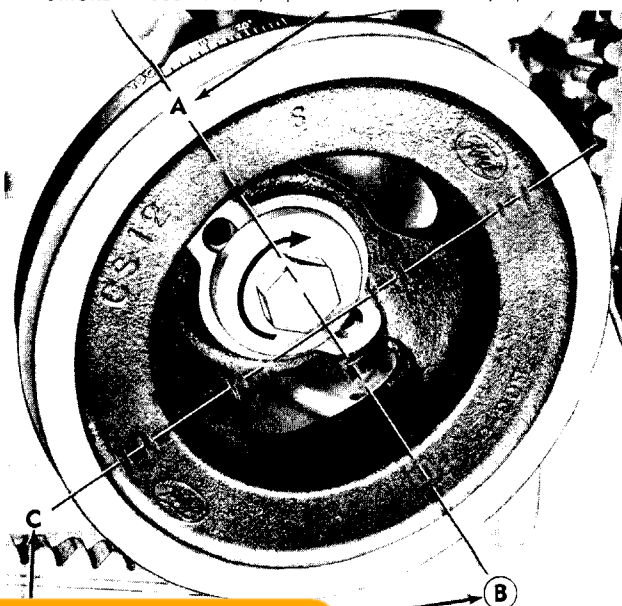

EXHAUST & NO. 4 & 5 INTAKE  
UST & NO. 3, 6, 8 INTAKE  
1022-B

sh Adjustment—



**BUY IT NOW!**

**Click Here To Order**



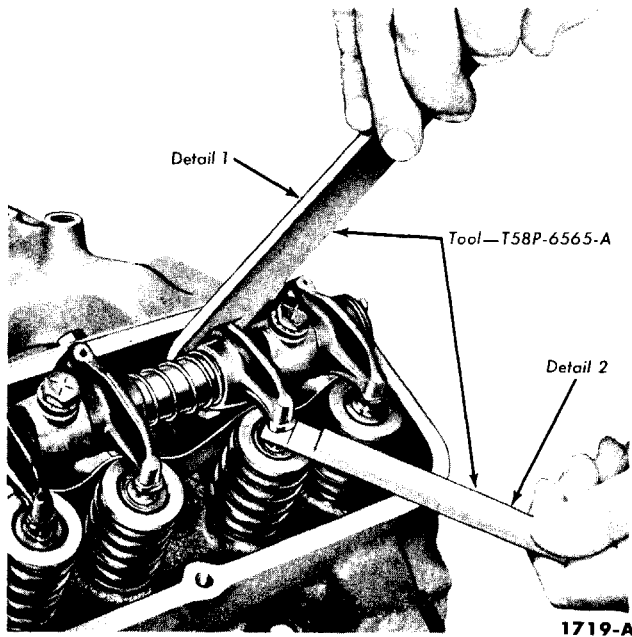

**FIG. 6—Valve Clearance—Thunderbird 332 or 352 Special and 352 Police Special V-8**

pletely bottomed (Fig. 6). Hold the lifter in the fully collapsed position and insert the clearance gauge (Fig. 6) between the valve stem and the rocker arm of the valve being checked. If the first step of the gauge enters, the old push rod may be used. If the first step will not enter, replace the standard push rod with a shorter service push rod. If the second step of the gauge enters,

the operating range of the lifter is excessive which indicates that the incorrect push rod has been installed or severe wear has occurred at the push rod ends, rocker arm, or valve stem. In this case, it will be necessary to determine the area of discrepancy and the incorrect or defective part(s) should be replaced.

2. Rotate the crankshaft until No. 1 piston is on T.D.C. at the end

of the compression stroke. With No. 1 piston on T.D.C., check the following valves:

No. 1 Intake	No. 1 Exhaust
No. 3 Intake	No. 4 Exhaust
No. 7 Intake	No. 5 Exhaust
No. 8 Intake	No. 8 Exhaust

3. After these valves have been checked, position No. 6 piston on T.D.C. and check the following valves:

No. 2 Intake	No. 2 Exhaust
No. 4 Intake	No. 3 Exhaust
No. 5 Intake	No. 6 Exhaust
No. 6 Intake	No. 7 Exhaust

**When compressing the valve spring to remove push rods, be sure the piston in the individual cylinder is below T.D.C. to avoid contact between the valve and the piston or serious damage may result.**

To replace a push rod, it will be necessary to remove the valve rocker arm shaft assembly.

Upon replacement of a valve push rod and/or valve rocker arm shaft assembly, the engine should not be cranked or rotated until the hydraulic lifters have had an opportunity to leak down to their normal operating position. The leak down rate can be accelerated by using the tool shown in Fig. 6 on the valve rocker arm applying pressure in a direction to collapse the lifter.

### MANIFOLD VACUUM TEST

A manifold vacuum test aids in determining the condition of an engine and also in helping to locate the cause of poor engine performance. To test manifold vacuum:

1. Operate the engine for a minimum of 30 minutes at 1200 rpm.

2. Install an accurate, sensitive vacuum gauge on the fuel pump end of the fuel pump vacuum line.

3. Operate the engine at recommended idle rpm.

4. Check the vacuum reading on the gauge.

### TEST CONCLUSIONS

Manifold vacuum is affected by carburetor adjustment, valve timing, the condition of the valves, cylinder compression, and leakage of the manifold, carburetor, or cylinder head gaskets.

Because abnormal gauge readings may indicate that more than one of the above factors is at fault, exercise caution in analyzing an abnormal reading. For example, if the vacuum

**TABLE 3—Manifold Vacuum Gauge Readings**

Gauge Reading	Engine Condition
18-19 inches (Mileage Maker Six) 19-20 inches (All V-8 engines)	Normal.
Low and steady.	Loss of power in all cylinders caused possibly by late ignition or valve timing, or loss of compression due to leakage around the piston rings.
Very low.	Manifold, carburetor, or cylinder head gasket leak.
Needle fluctuates steadily as speed increases.	A partial or complete loss of power in one or more cylinders caused by a leaking valve, cylinder head or intake manifold gasket leak, a defect in the ignition system, or a weak valve spring.
Gradual drop in reading at engine idle.	Excessive back pressure in the exhaust system.
	An occasional loss of power possibly caused by a defect in the ignition system or a sticking valve.
	Improper idle mixture adjustment, carburetor or intake manifold gasket leak, or possibly valve timing.



**BUY IT NOW!**

**Click Here To Order**



is low, the correction of one item may increase the vacuum enough so as to indicate that the trouble has been corrected. It is important, therefore, that each cause of an abnormal reading be investigated and further tests conducted where necessary in order to arrive at the correct diagnosis of the trouble.

Table 3 lists various types of readings and their possible causes.

Allowance should be made for the effect of altitude on the gauge reading. The engine vacuum will decrease with an increase in altitude.

### COMPRESSION TEST

1. Be sure the battery is good. Operate the engine for a minimum of 30 minutes at 1200 rpm. Turn the ignition switch off, then remove all the spark plugs.

2. Set the throttle plates (primary throttle plates only on the 4-barrel carburetor) and the choke plate in the wide open position.

3. Install a compression gauge in No. 1 cylinder.

4. Crank the engine several times and record the highest reading registered. Note the number of compression strokes required to obtain the highest reading.

5. Repeat the test on each cylinder, cranking the engine the same number of times for each cylinder as was required to obtain the highest reading on No. 1 cylinder.

### TEST CONCLUSIONS

A variation of  $\pm 20$  pounds (Thunderbird 332 or 352 Special and 352 Police Special V-8) or  $\pm 10$  pounds (Mileage Maker Six and Thunderbird 292 V-8) from specified pressure is satisfactory. However, the compression of all cylinders should be uniform within 10 pounds.

A reading of more than the allowable tolerance above normal indicates excessive deposits in the cylinder.

A reading of more than the allowable tolerance below normal indicates leakage at the cylinder head gasket, piston rings, or valves.

A low even compression in two adjacent cylinders indicates a cylinder head gasket leak. This should be checked before condemning the rings or valves.

To determine whether the rings or the valves are at fault, squirt the equivalent of a tablespoon of heavy oil into the combustion chamber, then crank the engine to distribute the oil and repeat the compression test. The oil will temporarily seal leakage past the rings. If approximately the same reading is obtained, the rings are satisfactory, but the valves are leaking. If the compression has increased 10 pounds or more over the original reading, there is leakage past the rings.

During a compression test, if the pressure fails to climb steadily and remains the same during the first two successive strokes, but climbs higher on the succeeding strokes, or fails to climb during the entire test, it indicates a sticking or stuck valve.

## 4 CLEANING, INSPECTION, AND RECONDITIONING

### INTAKE MANIFOLD

Clean the manifolds in a suitable solvent, then dry them with compressed air. Scrape all carbon deposits from the center exhaust passage below the carburetor heat riser. This carbon acts as an insulator restricting the heating action of the hot exhaust gases.

Inspect the manifold for cracks, leaks, or other defects that would make it unfit for further service. Replace all studs that are stripped or otherwise damaged. **Remove all filings and foreign matter that may have entered the manifold as a result of repairs.**

On the Thunderbird 292 V-8, blow out the automatic choke passages of the intake manifold with compressed air. Make sure the passages are completely open, otherwise choke operation will be impaired. Check the automatic choke air heat tube that passes through the intake manifold for leaks, as

pump does not maintain a steady reading there is a leak in the tube and the tube should be replaced.

On the Thunderbird 332 or 352 Special and the 352 Police Special V-8, check the baffle plate on the underside of the manifold for looseness and be sure the maze screen is in place. Clean off any varnish accumulation.

### EXHAUST MANIFOLD

Inspect the manifold(s) for cracks, leaks, or other defects that would make it unfit for further service.

On the right exhaust manifold of the Thunderbird 332 or 352 Special and 352 Police Special V-8, clean out the automatic choke air heat chamber (Fig. 7). Make sure the air inlet and outlet holes are completely

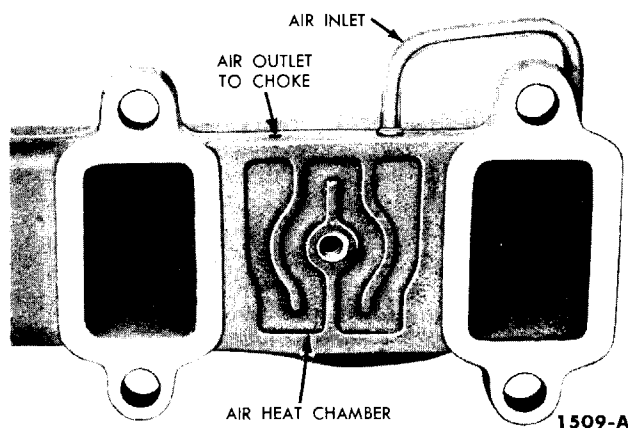

FIG. 7—Automatic Choke Air Heat Chamber—Thunderbird 332 or 352 Special and 352 Police Special V-8

**100% SATISFACTION GUARANTEED**

**BUY IT NOW!**

**Click Here To Order**

PayPal, American Express, Discover, MasterCard, VISA



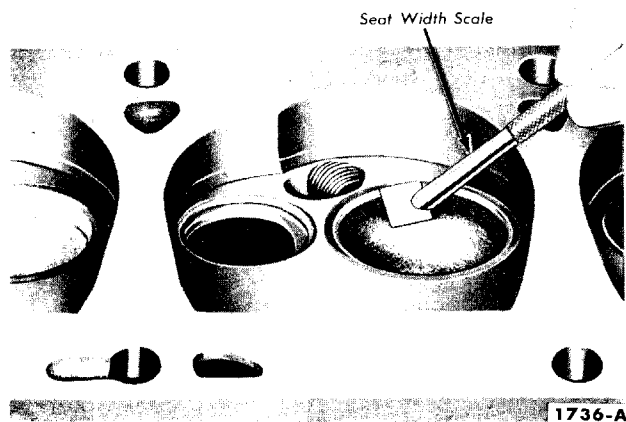

FIG. 11—Valve Seat Width—Typical

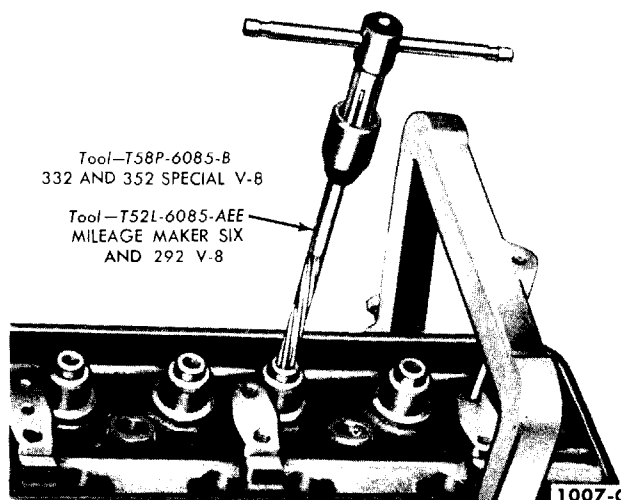

FIG. 12—Reaming Valve Guides—Typical

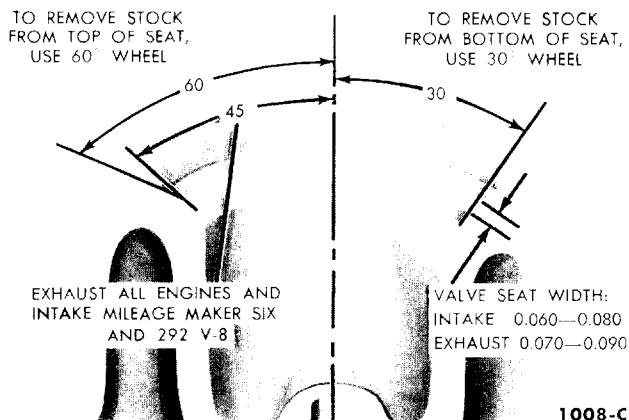

FIG. 13—Valve Seat Refacing—Exhaust All Engines and Intake Mileage Maker Six and Thunderbird 292 V-8

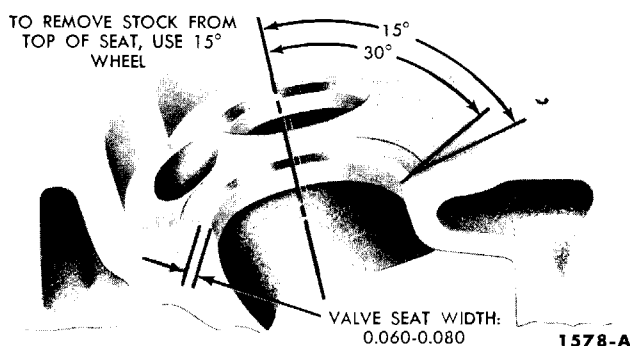

FIG. 14—Intake Valve Seat Refacing—Thunderbird 332 or 352 Special and 352 Police Special V-8

When going from a standard size valve to an oversize valve, always use the reamers in sequence. **Always reface the valve seat after the valve guide has been reamed.**

**REFACING VALVE SEATS**

Refacing of the valve seats should be closely co-ordinated with the refacing of the valve face so the finished seat will match the valve face and be centered. This is important so that the valve and seat will have a good compression tight fit. Be sure that the refacer grinding wheels are properly dressed.

Police Special V-8 to a true 30° angle (Fig. 14). Remove only enough stock to clean up pits, grooves, or to correct the valve seat runoff. After the seat has been refaced, measure the seat width (Fig. 11). Narrow the seat, if necessary to bring it within limits.

If the valve seat width exceeds the maximum limits, remove enough stock from the top edge and/or bottom edge of the seat to reduce the width to specifications (Fig. 13 or 14).

On the exhaust valve seats of all engines and the intake valve seats of the Mileage Maker Six and Thunderbird 292 V-8, use a 30° angle grinding wheel to remove stock from the bottom of the seats (raise the seats) and use a 60° angle wheel to remove stock from the top of the seats (lower the seats).

On the intake valve seats of the

Thunderbird 332 or 352 Special and the 352 Police Special V-8, use a 15° angle grinding wheel to remove stock from the top of the seats (lower the seats).

The finished valve seat should contact the approximate center of the valve face. To determine where the valve seat contacts the face, coat the seat with Prussian blue, then set the valve in place. Rotate the valve with light pressure. If the blue is transferred to the center of the valve face, the contact is satisfactory. If the blue is transferred to the top edge of the valve face, lower the valve seat. If the blue is transferred to the bottom edge of the valve face, raise the valve seat.

After refacing the valve seat, it is good practice to lightly lap in the valve with a medium grade lapping compound. Remove all the compound from the valve and seat after the lapping operation.

**100% SATISFACTION GUARANTEED**

**BUY IT NOW!**

**Click Here To Order**

Like Valve Seat of the Thunderbird

PayPal | American Express | Discover | MasterCard | VISA

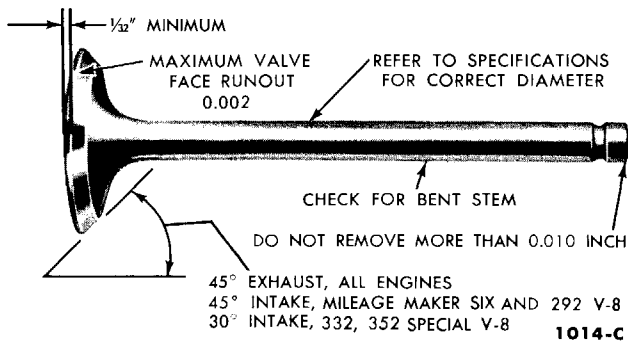
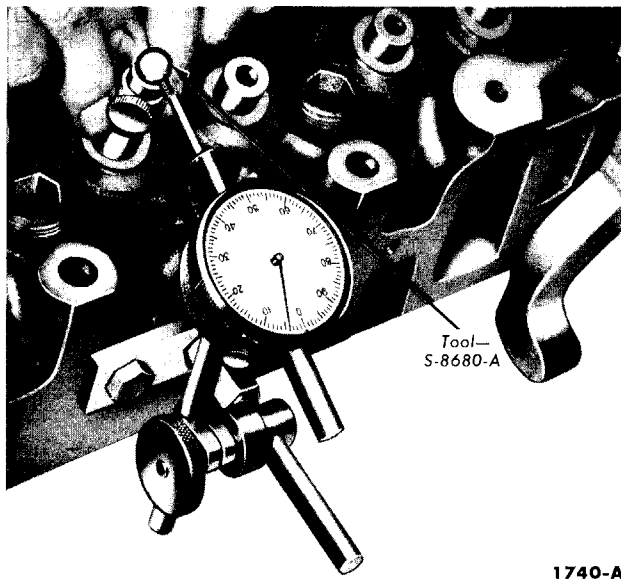

FIG. 15—Critical Valve Tolerances



1740-A

FIG. 17—Typical Valve Stem Clearance

**VALVES**

**CLEANING AND INSPECTION**

Remove all deposits from the valve with a fine wire brush or buffing wheel. The critical inspection points and tolerances of the valves are illustrated in Fig. 15.

Inspect the valve face and the edge of the valve head for pits, grooves, scores, or other defects. Inspect the stem for a bent condition and the end of the stem for grooves or scores. Check the valve head for signs of burning or erosion, warpage, and cracking. De-

**VALVE FACE RUNOUT**

Check the valve face runout (Fig. 16). The wear limit is 0.002 inch total indicator reading.

**VALVE STEM CLEARANCE**

Check the valve stem to valve guide clearance of each valve in its respective valve guide with the tool shown in Fig. 17 or its equivalent.

Install the tool on the valve stem until fully seated and tighten the set screw, then permit the valve to drop away from its seat until the tool contacts the upper surface of the valve guide. Position a dial indicator with a flat tip against the center portion of the spherical section of the tool at approximately 90° to the valve stem. Move the tool back and forth on a plane that parallels normal rocker arm action and take the indicator reading without lifting the

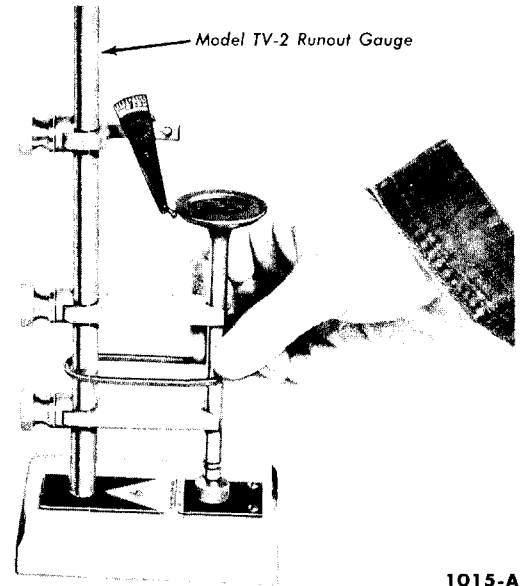

1015-A

FIG. 16—Valve Face Runout

tool from the valve guide upper surface. Divide the indicator reading by 2 (division factor of the tool) to obtain the actual stem clearance. If the clearance exceeds the wear limit, try a new valve.

**VALVE SPRING PRESSURE**

Check the spring for proper pressure (Fig. 18). Do not remove the damper spring from the 352 Police Special V-8 when checking the pressure. Weak valve springs cause poor engine performance; therefore, if the pressure of any spring approaches the wear limit, replace the spring.

**VALVE SPRING SQUARENESS**

Check each spring for squareness using a steel square and a surface plate (Fig. 19). Stand the spring and square on end on the surface plate. Slide the spring up to the square. Revolve the spring slowly and observe the space between the top coil of the spring and the square. If the spring is out of square more than 1/16 inch, replace it.

**REFACING VALVES**

The valve refacing operation should be closely co-ordinated with the valve seat refacing operation so that the finished angle of the valve face will match the valve seat. This is important so that the valve and seat will have a good compression tight fit. Be sure that the refacer grinding wheels are properly dressed.

If the valve face runout is exces-

**100% SATISFACTION GUARANTEED**

**BUY IT NOW!**

**Click Here To Order**

PayPal, American Express, Discover, MasterCard, VISA

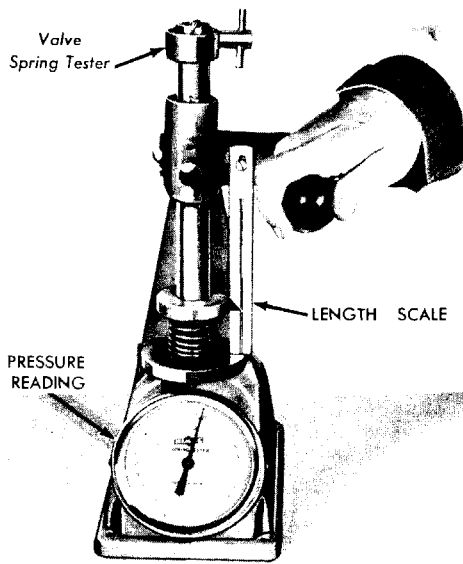

1017-A

FIG. 18—Valve Spring Pressure

sive and/or to remove pits and grooves, reface the exhaust valves of all engines and the intake valves of the Mileage Maker Six and Thunderbird 292 V-8 to a true 45° angle. Reface the intake valves of the Thunderbird 332 and 352 Special and the 352 Police Special V-8 to a true 30° angle. Remove only enough stock to correct the runout or to clean up the pits and grooves. If the edge of the valve head is less than 1/32 inch after grinding, replace the valve as the valve will run too hot in the engine.

Remove all grooves or score marks from the end of the valve stem, then chamfer as necessary. Do not remove more than 0.010 inch from the stem.

After refacing the valves, it is good practice to lightly lap in the valves with a medium grade lapping compound to match the seats. Be sure to remove all the compound from the valve and seat after the lapping operation.

#### SELECT FITTING VALVES

If the valve stem to valve guide clearance exceeds the wear limit, it is recommended that the valve

#### HYDRAULIC VALVE LIFTERS— THUNDERBIRD 332 OR 352 SPECIAL AND 352 POLICE SPECIAL V-8

The lifter assemblies should be kept in proper sequence so that they can be installed in their original position. Inspect and test each lifter separately so as not to intermix the internal parts. **If any part of the lifter assembly needs replacement, replace the entire assembly.**

#### CLEANING AND INSPECTION

Thoroughly clean all the parts in clean solvent and wipe them with a clean, lint free cloth.

Inspect the parts and discard the entire lifter assembly if any part shows signs of pitting, scoring, galling, or evidence of non-rotation. Also, replace the entire assembly if the plunger is not free in the body. The plunger should drop to the bottom of the body by its own weight.

Assemble the lifter assembly and check the assembly for freeness of operation by pressing down on the push rod cup. Also, the lifter assemblies can be tested with a hydraulic valve lifter tester to test the leak down rate. The leak down rate specification is 8-45 seconds. Follow the instructions of the test unit manufacturer.

#### ROCKER ARM TO VALVE CLEARANCE

If the valve and/or valve seat have been refaced, it will be necessary to check the clearance between

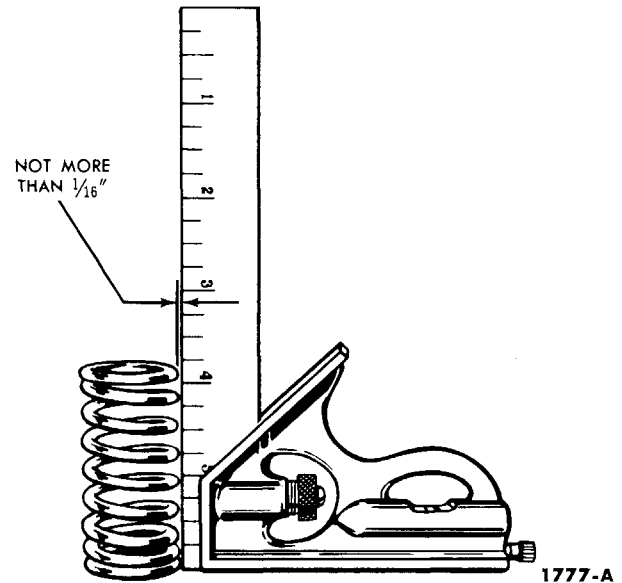

1777-A

FIG. 19—Valve Spring Squareness

the rocker arm pad and the valve stem with the valve train assembly installed in the engine.

#### TIMING CHAIN

Clean all parts in solvent and dry them with compressed air. Inspect the chain for broken links and the sprockets for cracks, and worn or damaged teeth. It is recommended that all the components be replaced if any one item needs replacement.

#### CAMSHAFT AND BEARINGS

Clean the camshaft in solvent and wipe dry. Inspect the camshaft lobes for pitting, scoring, and signs of abnormal wear. Lobe wear characteristics may result in pitting in the general area of the nose portion of the lobe. This pitting is not detrimental to the operation of the camshaft, therefore, the camshaft should not be replaced until the lobe lift loss has exceeded 0.005 inch. The lift of camshaft lobes can only be accurately checked with the camshaft installed in the engine. Refer to "Camshaft Lobe Lift" in Section 3 of this part.

Check the camshaft journal to bearing clearances by measuring the diameter of the journals and the I.D. of the bearings. If the clearance exceeds the wear limit, the camshaft journals should be refinished for undersized bearings or the camshaft replaced, and/or the bearings should be replaced. Bearings are

100% SATISFACTION GUARANTEED

**BUY IT NOW!**

Click Here To Order

PayPal, American Express, Discover, MasterCard, VISA

available prefinished to size for standard and 0.015-inch undersize journal diameters.

Check the distributor drive gear for broken or chipped teeth.

Remove light scuffs, scores, or nicks from the camshaft machined surfaces with a smooth oilstone.

## CRANKSHAFT

### CLEANING AND INSPECTION

Handle the crankshaft with care to avoid possible fractures or damage to the finished surfaces. Clean the crankshaft with solvent, then blow out all oil passages with compressed air.

Inspect main and connecting rod journals for cracks, scratches, grooves, or scores. Dress minor imperfections with an oilstone. Refinish severely marred journals.

Measure the diameter of each journal in at least four places to determine out-of-round, taper, or undersize condition (Fig. 20).

If the journals exceed the wear limit, they should be refinished to size for the next undersize bearing.

### REFINISHING JOURNALS

Refinish the journal to give the proper clearance with the next undersize bearing. If the journal will not "clean up" to give the proper clearance with the maximum undersize bearing available, replace the crankshaft.

Always reproduce the same journal shoulder radius that existed originally. Too small a radius will result in fatigue failure of the crankshaft. Too large a radius will result in bearing failure due to radius ride of the bearing.

After refinishing the journals, chamfer the oil holes, then polish the journal with a No. 320 grit polishing cloth and engine oil. Crocus cloth may be used also as a polishing agent.

## CONNECTING RODS

The connecting rods and related parts should be carefully inspected and checked for conformance to specifications. Various forms of en-

lation to the piston skirt and ring grooves.

Abnormal connecting rod bearing wear can be caused by either a bent connecting rod, an improperly machined crankpin, or a tapered connecting rod bore.

Twisted connecting rods will not create an easily identifiable wear pattern, but badly twisted rods will disturb the action of the entire piston, rings, and connecting rod assembly and may be the cause of excessive oil consumption.

### CLEANING AND INSPECTION

Clean the connecting rod in solvent, including the connecting rod bore and the back of the inserts. **Do not use a caustic cleaning solution.** Blow out all passages with compressed air.

Inspect the connecting rods for signs of fractures and the bearing bores for out-of-round and taper. If the bore exceeds the recommended limits and/or if the connecting rod is fractured, it should be replaced.

Check the piston pin to connecting rod bushing clearance. Replace the connecting rod if the bushing is so worn that it cannot be reamed or honed for an oversize pin.

Replace defective connecting rod nuts and bolts.

After the connecting rods are assembled to the piston, check them for bend or twist on a suitable alignment fixture. Follow the instructions of the fixture manufacturer. If the bend and/or twist is excessive, the connecting rod should be straightened or replaced.

A VS B = VERTICAL TAPER  
C VS D = HORIZONTAL TAPER  
A VS C AND B VS D = OUT OF ROUND  
CHECK FOR OUT-OF-ROUND AT EACH END OF JOURNAL

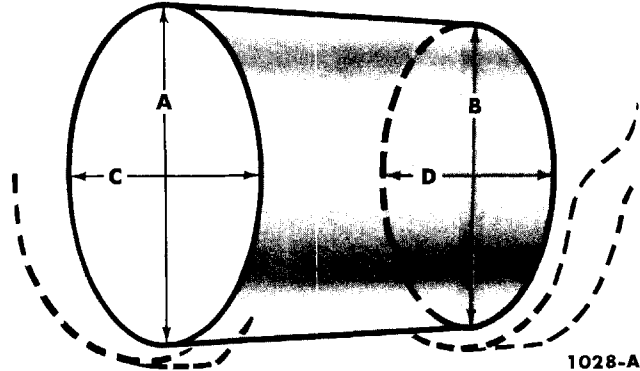

FIG. 20—Camshaft Journal Measurements

## PISTONS, PINS, AND RINGS

### CLEANING AND INSPECTION

Remove deposits from the piston surfaces and from the underside of the piston head. Clean gum or varnish from the piston skirt, piston pins, and rings with solvent. **Do not use a caustic cleaning solution or a wire brush to clean pistons.** Clean the ring grooves with a ring groove cleaner (Fig. 21). Make sure the oil ring slots (or holes) are clean.

Carefully inspect the pistons for fractures at the ring lands, skirts, and pin bosses, and for scuffed, rough, or scored skirts. If the lower inner portion of the ring grooves have high steps, replace the piston. The step will interfere with ring operation and cause excessive ring side clearance.

Spongy, eroded areas near the edge of the top of the piston are usually caused by detonation, or pre-ignition. A shiny surface on the thrust surface of the piston, offset from the centerline between the piston pin holes, can be caused by a bent connecting rod. Replace pistons that show signs of excessive wear, wavy ring lands, fractures, and/or damage from detonation or pre-ignition.

Check the piston to cylinder bore clearance with a tension scale and ribbon and the ring side clearance following the recommended procedures.

Replace piston pins showing signs of fracture or etching and/or wear. Check the piston pin fit in the piston and rod bushing.

**100% SATISFACTION GUARANTEED**

**BUY IT NOW!**

**Click Here To Order**

PayPal, American Express, Discover, MasterCard, VISA

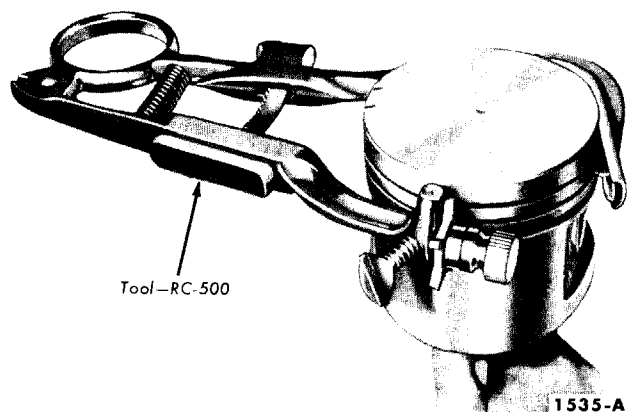

**FIG. 21—Cleaning Ring Grooves**

Replace all rings that are scored, chipped, or cracked. Check the end gap and side clearance. It is good practice to always install new rings when overhauling the engine. **Rings should not be transferred from one piston to another regardless of mileage.**

#### FITTING PISTONS

Pistons are available for service in standard sizes and 0.003, 0.020, 0.030, 0.040, and 0.060-inch over-size. Standard size pistons are divided into two sizes and are identified by a daub of red or blue paint. Refer to the specification section for the available sizes.

The piston and cylinder block should be at room temperature (70° F) when the piston fit is checked. **After any refinishing operation, allow the cylinder bore to cool before the piston fit is checked.**

Calculate the size piston to be used by taking a cylinder bore check (Fig. 28), then select the proper size piston to provide the desired clearance.

Make sure the piston and cylinder bore are clean and dry. Attach a tension scale to the end of a feeler gauge ribbon that is free of dents or burrs. The feeler ribbon should be ½ inch wide and of one of the thicknesses listed in Table 4.

Position the ribbon in the cylinder bore so that it extends the entire length of the piston at 90° from the piston pin location. Invert the piston and install it in the bore

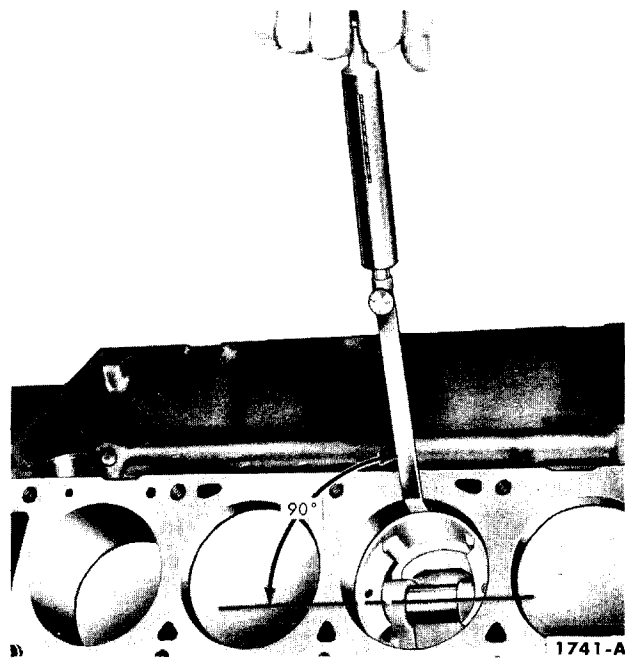

**FIG. 22—Checking Piston Fit—Typical**

remove the feeler ribbon (Fig. 22). The piston to cylinder bore clearance should be from 0.0008-0.0026 inch. The wear limit is 0.005 inch.

In Table 4, the diagonal lines represent feeler ribbons of various thicknesses, the horizontal lines represent the pounds pull, and the vertical lines represent the clearances. To determine the clearance, locate the line representing the pounds pull required to remove the feeler ribbon from the cylinder bore. Follow the horizontal line to the right until it intersects the diagonal line representing the feeler ribbon. Read down the vertical line for the clearance.

**Example 1.** If a 0.0015-inch feeler ribbon is used and it takes approximately 4¼ pounds pull to remove the feeler ribbon, the clearance is approximately 0.0008 inch. This is determined by locating the pounds pull (4¼) in Table 4 and following the line to the right until it intersects with the diagonal line representing the 0.0015-inch feeler ribbon. Read down the vertical line for the clearance (approximately 0.0008 inch).

**Example 2.** If a 0.003-inch feeler ribbon is used and it takes approximately 9 pounds pull to remove the ribbon, the resultant clearance is approximately 0.0015 inch.

**Example 3.** If a 0.003-inch feeler ribbon is used and it takes approximately 4 pounds pull to remove the feeler ribbon, the resultant clearance

is approximately 0.0026 inch.

If the clearance is greater than the maximum limit, recheck calculations to be sure that the proper size piston has been selected, check for a damaged piston, then try a new piston.

If the clearance is less than the minimum limit, recheck calculations before trying another piston. If none can be fitted, refinish the cylinder for the next size piston.

**When a piston has been fitted, mark it for assembly in the cylinder to which it was fitted.**

If the taper and out-of-round conditions of the cylinder bore are within limits, new piston rings will give satisfactory service provided the piston clearance in the cylinder bore is within limits. If the new rings are to be installed in a used cylinder that has not been refinished, remove the cylinder wall "glaze."

Select the proper ring set for the size piston to be used. The rings must be checked for proper gap in the cylinder bore and for the proper side clearance in the piston grooves. First, check each ring for proper gap as follows:

Position the ring in the cylinder bore in which it is going to be used. Push the ring down into the cylinder bore area where normal ring wear is not encountered. Use the head of a piston to position the

**100% SATISFACTION GUARANTEED**

**BUY IT NOW!**

**Click Here To Order**

PayPal | American Express | Discover | MasterCard | VISA

TABLE 4—Piston Clearance

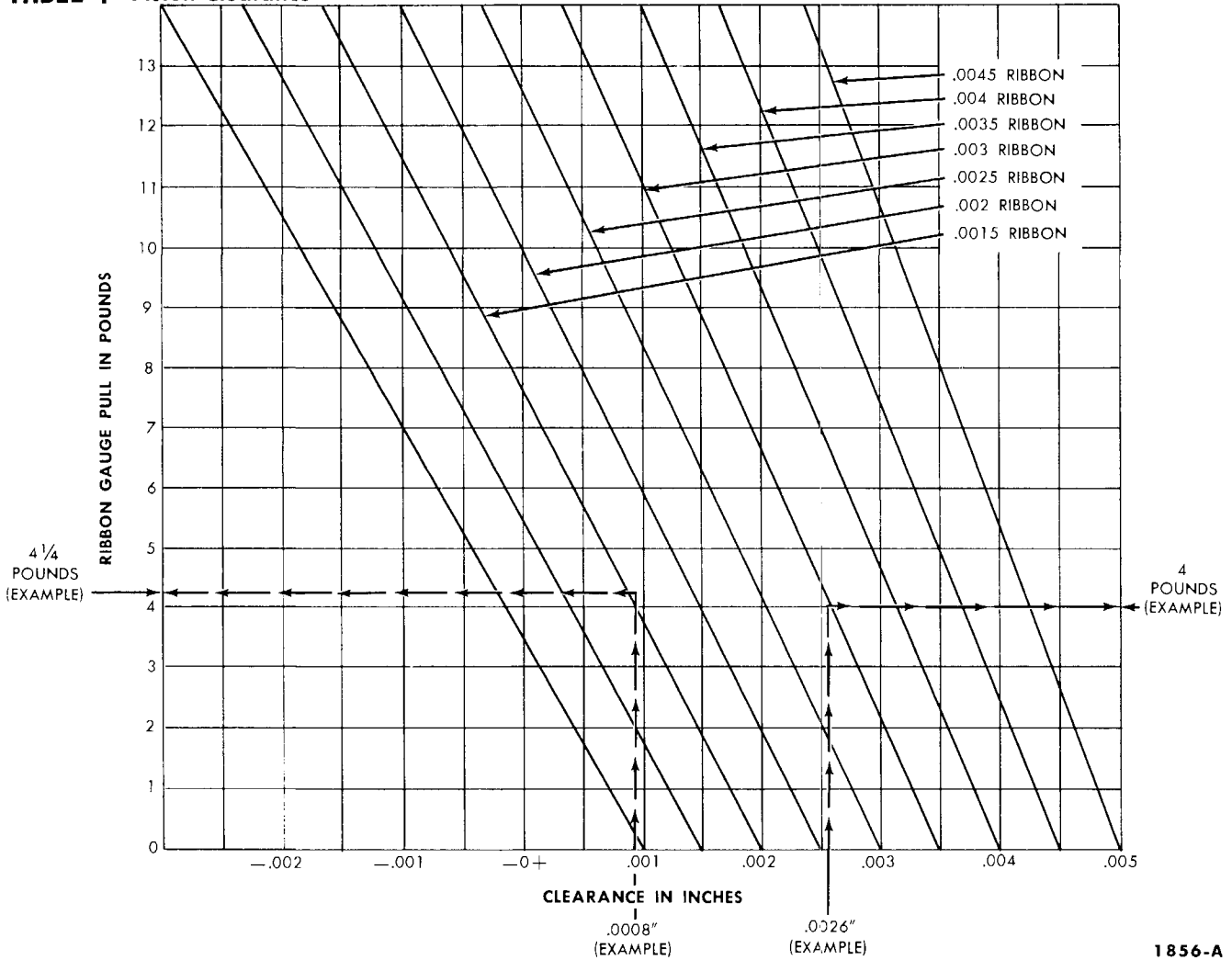

1856-A

ring so that the ring is square with the cylinder wall. **Use caution to avoid damage to the ring or cylinder bore.** Measure the gap between the ends of the ring with a feeler gauge (Fig. 23).

If the gap is less than the recommended lower limit, try another ring set.

**FITTING PISTON PINS**

The piston pin fit should be a light thumb press fit at normal temperature (70°F). Standard piston pins are color coded green. Pins of 0.001-inch oversize (color coded blue) and 0.002-inch oversize (color coded yellow) are available.

the pin bore. Take a light cut. Use a pilot sleeve of the nearest size to maintain alignment of the bores.

Check the hole size, using the new piston pin. If the bore is small, expand the reamer slightly and make another cut. Repeat the procedure until the proper fit is obtained. Check the piston pin for fit in the respective rod bushing. If necessary, ream or hone the bushing to fit the pin.

Install the piston pin in the piston and rod. Install a new retainer at each end of the pin to hold it in place. Spiral the retainers into position with the fingers. Do not use pliers. Make sure the retainers are properly seated in their groove.

thoroughly. Inspect each bearing carefully. Bearings that have a scored, chipped, or worn surface should be replaced. Typical examples of bearing failures and their causes are shown in Fig. 24. Check the clearance of bearings that appear to be satisfactory with Plastigage. Fit new bearings following the recommended procedure.

**BEARING REPLACEMENT**

The main and connecting rod bearing inserts are selective fit and do not require reaming to size upon installation. **Do not file or lap bearing caps or use shims to obtain the proper bearing clearance.**

Selective fit bearings are available for service in standard sizes only. Standard bearings are divided into two sizes and are identified by a daub of red or blue paint. **Red marked bearings increase the clearance; blue marked bearings decrease**

**MAIN AND CONNECTING ROD BEARINGS**

**CLEANING AND INSPECTION**

Clean the bearing inserts and caps

**100% SATISFACTION GUARANTEED**

**BUY IT NOW!**

**Click Here To Order**

PayPal, American Express, Discover, MasterCard, VISA

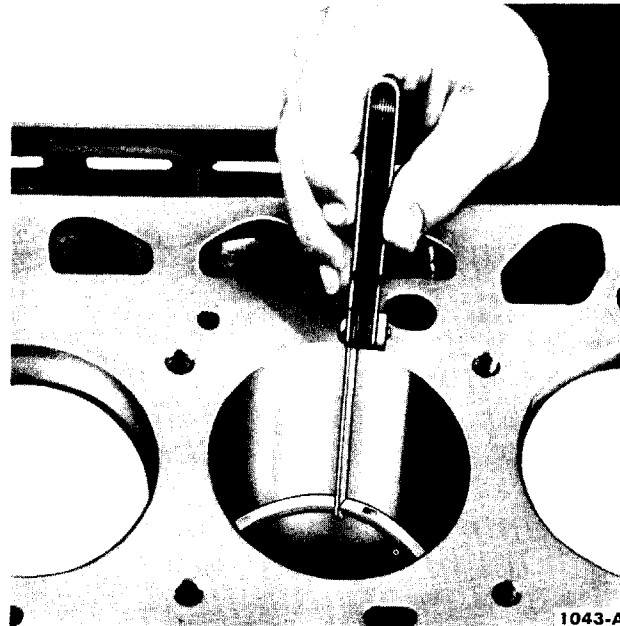

FIG. 23—Typical Piston Ring Gap

**the clearance.** Undersized bearings, which are not selective fit, are available for use on journals that have been refinished.

Normally, bearing journals wear evenly and are not out-of-round. However, if a bearing is being fitted to an out-of-round journal, be sure to fit the bearing to the maximum diameter of the journal. If the bearing is fitted to the minimum diameter with minimum clearance, interference may result, causing an early failure. It is not recommended that bearings be fitted to a crankshaft journal which exceeds the maximum

out-of-round specifications. **When replacing standard bearings with new bearings, it is good practice to first try to obtain the proper clearance with two blue bearing halves.**

When checking the width of the Plastigage, check at the widest point in order to get the minimum clearance. Check at the narrowest point in order to get the maximum clearance. The difference between the two readings is the taper.

If the clearance is less than the specified limits, try two red bearing halves or a combination of red and blue depending upon the condition.

If the standard bearings do not bring the clearance within the desired limits, refinish the crankshaft journal, then install undersize bearings.

Do not get foreign matter under the inserts. In time the foreign matter may distort the bearing and cause bearing failure.

**Main Bearings.** The following procedure is for the engine installed in the chassis with the crankshaft not removed. If the engine is on a work stand, omit step 1 and follow steps 2-5. In step 3, if the engine is on a work stand, it is not necessary to

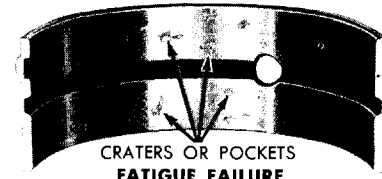
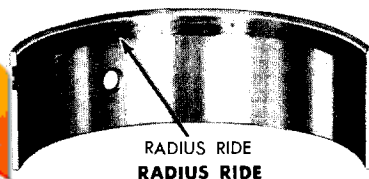
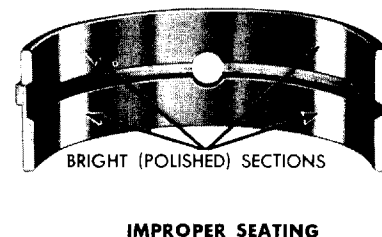
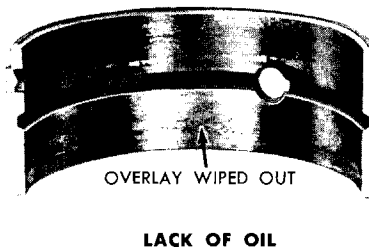
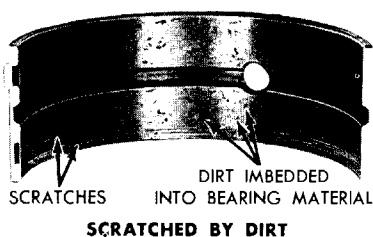

1030-A

**100% SATISFACTION GUARANTEED**

**BUY IT NOW!**

**Click Here To Order**

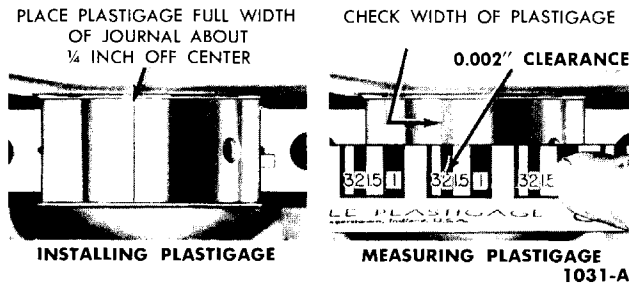

FIG. 25—Installing and Measuring Plastigage—Engine on Work Stand

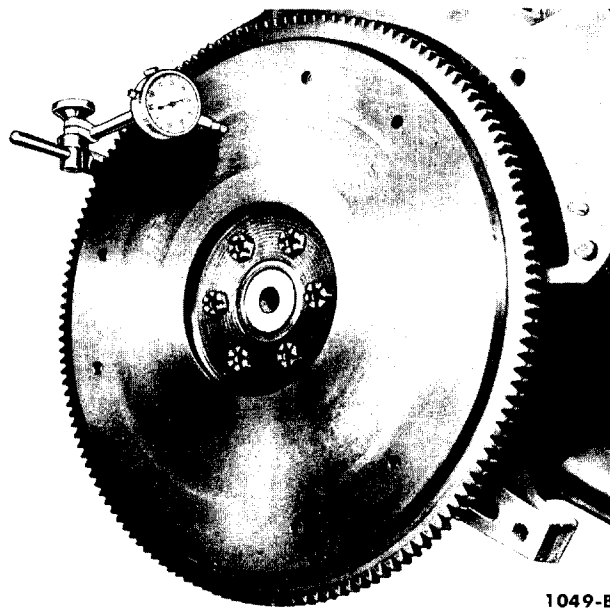

FIG. 27—Typical Flywheel Face Runout

support the crankshaft because the engine will be inverted. Also in step 3 place the Plastigage on the crankshaft journal (Fig. 25) instead of on the bearing surface if the engine is on a work stand.

1. Replace one bearing at a time, leaving the other bearings securely fastened. Remove the main bearing cap to which new bearings are to be installed. Insert the upper bearing removal tool (tool 6331) in the oil hole in the crankshaft. Rotate the crankshaft in the direction of engine rotation to force the bearing out of the block.

2. To install the upper main bearing, place the plain end of the bearing over the shaft on the locking

bearing. Clean the crankshaft journal and bearings.

3. Support the crankshaft so its weight will not compress the Plastigage and provide an erroneous reading. Position a small jack so it will bear against the counterweight adjoining the bearing which is being checked. Place a piece of Plastigage on the bearing surface the full width of the bearing cap and about 1/4 inch off center (Fig. 26). Install the cap and tighten the bolts to specifications. Do not turn the crankshaft while the Plastigage is in place. Remove the cap, then using the Plastigage scale, check the width of the Plastigage.

4. After the bearing has been checked and found to be satisfactory, apply a light coat of engine oil to the journal and bearings, then install the bearing cap. Tighten the cap bolts to specifications.

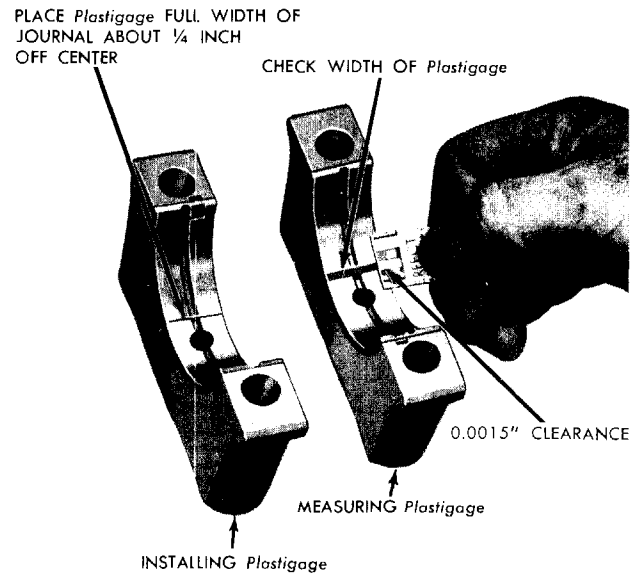

1558-B

FIG. 26—Installing and Measuring Plastigage—Engine in Chassis

5. If the rear main bearing is replaced, replace the lower oil seal (in the seal retainer or rear main bearing cap) and the side seals. The upper oil seal (in the block) cannot be replaced with the crankshaft installed.

**Connecting Rod Bearings.**

1. Install the new bearings in the connecting rod and cap. Pull the connecting rod assembly down firmly on the crankshaft journal. Place a piece of Plastigage on the lower bearing surface, the full width of the cap and about 1/4 inch off center. Install the cap and tighten the connecting rod nuts to specifications. Do not turn the crankshaft while the Plastigage is in place.

2. Remove the cap, then using the Plastigage scale check the width of the Plastigage.

After the bearing clearance has been checked and found to be satisfactory, apply a light coat of engine oil to the journal and bearings, then install the connecting rod cap.

3. Repeat the procedure for the remaining connecting rods that require new bearings.

**FLYWHEEL—MANUAL-SHIFT TRANSMISSIONS**

**INSPECTION**

Inspect the flywheel for cracks, heat check, or other defects that

**100% SATISFACTION GUARANTEED**

**BUY IT NOW!**

**Click Here To Order**

Remove the tool. Restore the cap.

PayPal American Express Discover NetPlus MasterCard VISA

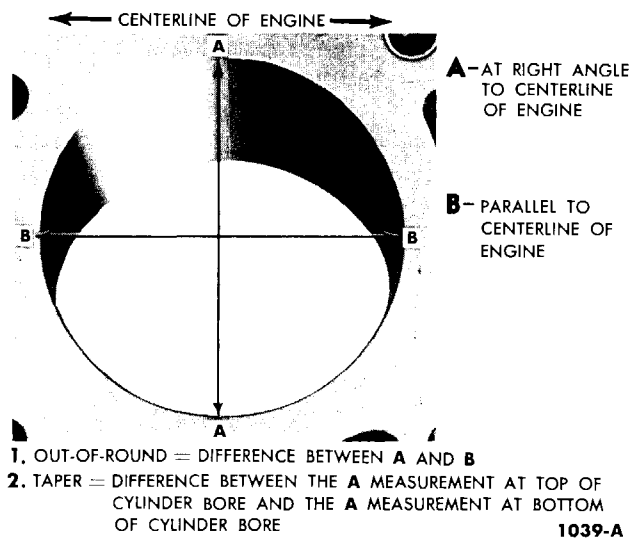

**FIG. 28—Cylinder Bore Out-Of-Round and Taper**

would make it unfit for further service. Machine the friction surface of the flywheel if it is scored or worn. If it is necessary to remove more than 0.045 inch of stock from the original thickness, replace the flywheel.

Inspect the ring gear for worn, chipped, or cracked teeth. If the teeth are damaged, replace the ring gear.

With the flywheel installed on the crankshaft, check the flywheel face runout.

#### FLYWHEEL FACE RUNOUT

Install a dial indicator so that the indicator point bears against the flywheel face (Fig. 27). Turn the flywheel making sure that it is full forward or rearward so that crankshaft end play will not be indicated as flywheel runout.

If the runout exceeds the maximum limit, remove the flywheel and check for burrs between the flywheel and the face of the crankshaft mounting flange. If no burrs exist, check the runout of the crankshaft mounting flange. Replace the flywheel or machine the crankshaft flywheel face if the mounting flange is excessive.

Heat the new ring gear evenly until the gear expands enough to slip onto the flywheel. Make sure the gear is seated properly against the shoulder. **Do not heat any portion of the gear to a temperature higher than 500°F. If this limit is exceeded, the temper will be removed from the ring gear teeth.**

#### CYLINDER BLOCK

During the disassembly of the cylinder block for engine overhaul, closely inspect the wear pattern on all parts to help diagnose the cause of wear.

#### CLEANING AND INSPECTION

Thoroughly clean the block in solvent. Remove old gasket material from all machined surfaces. Remove all pipe plugs which seal oil passages, then clean out all the passages. Blow out all passages, bolt holes, etc. with compressed air. Make sure the threads in the cylinder head bolt holes are clean. Dirt in the threads may cause binding and result in a false torque reading. Use a tap to true-up threads and to remove any deposits.

After the block has been thoroughly cleaned, make a check for cracks. Minute cracks not visible to the naked eye may be detected by coating the suspected area with a mixture of 25% kerosene and 75% light motor oil. Wipe the part dry and immediately apply a coating of zinc oxide dissolved in wood alcohol.

If cracks are present, the coating will become discolored at the defective area. Replace the block if it is cracked.

Check all machined gasket surfaces for burrs, nicks, scratches, and scores. Remove minor imperfections with an oil stone. Check the flatness of the cylinder block gasket surface following the procedure and specifications recommended for the cylinder head.

Replace all expansion-type plugs that show evidence of leakage.

Inspect the cylinder walls for scoring, roughness, or other signs of wear. Check the cylinder bore for out-of-round and taper. Measure the bore with an accurate gauge following the instructions of the manufacturer. Measure the diameter of each cylinder bore at the top, middle, and bottom with the gauge placed at right angles and parallel to the centerline of the engine (Fig. 28).

Refinish cylinders that are deeply scored and/or when out-of-round and/or taper exceed the wear limits.

If the cylinder walls have minor surface imperfections, but the out-of-round and taper are within limits, it may be possible to remove the imperfections by honing the cylinder walls and installing new service piston rings providing the piston clearance is within limits. Use the finest grade of honing stone for this operation.

#### REFINISHING CYLINDER WALLS

Honing is recommended for refinishing cylinder walls only when the walls have minor imperfections, such as light scuffs, scratches, etc. The grade of hone to be used is determined by the amount of metal to be removed. Follow the instructions of the hone manufacturer. If coarse stones are used to start the honing operation, leave enough material so that all hone marks can be removed with the finishing hone which is used to obtain the proper piston clearance.

Cylinder walls that are severely marred and/or worn beyond the specified limits should be refinished. Before any cylinder is refinished, all main bearing caps must be in place and tightened to the proper torque so that the crankshaft bearing bores

**100% SATISFACTION GUARANTEED**

**BUY IT NOW!**

**Click Here To Order**

PayPal, American Express, Discover, MasterCard, VISA

will not become distorted from the refinishing operation.

Refinish only the cylinder or cylinders that require it. **All pistons are the same weight, both standard and oversize; therefore, various sized pistons can be intermixed without upsetting engine balance.**

Refinish the cylinder with the most wear first to determine the maximum oversize. If the cylinder will not clean up when refinished for the maximum oversize piston recommended, replace the block.

Refinish the cylinder to within approximately 0.0015 inch of the required oversize diameter. This will allow enough stock for the final step of honing so the correct surface finish and pattern are obtained. Use clean sharp hones of No. 220-280 grit for this operation.

For the proper use of the refinishing equipment follow the instructions of the manufacturer. Only experienced personnel should be allowed to perform this work.

After the final operation in either of the two refinishing methods described and prior to checking the piston fit, thoroughly wash the cylinder walls with solvent to remove all abrasive particles, then thoroughly dry the walls. Check the piston fit. Mark the pistons to correspond to the cylinders in which they are to be installed. When the refinishing of all cylinders that require it has been completed and all pistons fitted, thoroughly clean the entire block to remove all particles from the bearing bores, oil passages, cylinder

head bolt holes, etc. Coat the cylinder walls with oil.

## OIL PAN AND OIL PUMPS

### OIL PAN

Scrape any dirt or metal particles from the inside of the pan. Scrape all old gasket material from the gasket surface. Wash the pan in a solvent and dry it thoroughly. Be sure all foreign matter is removed from below the baffle plate.

Check the pan for cracks, holes, damaged drain plug threads, a loose baffle, and a nicked or warped gasket surface.

Repair any damage, or replace the pan if repairs can not be made.

### OIL PUMPS

**Cleaning.** Wash all parts in a solvent and dry them thoroughly. Use a brush to clean the inside of the pump housing and the pressure relief valve chamber. Be sure all dirt and chips are removed.

On the gear-type oil pump, remove old gasket material from the pump body and cover.

**Inspection — Rotor-Type Oil Pump.** Check the inside of the pump housing and the outer race and rotor for damage or excessive wear.

Check the mating surface of the pump cover for wear. If the cover mating surface is worn, scored, or grooved, replace the cover.

Measure the outer race to housing clearance (Fig. 29).

With the rotor assembly installed in the housing, place a straight edge over the rotor assembly and the housing. Measure the clearance between the straight edge and the rotor and outer race (Fig. 30).

**The outer race, shaft and rotor are replaceable only as an assembly.**

Check the drive shaft to housing bearing clearance by measuring the O.D. of the shaft and the I.D. of the housing bearing.

Inspect the relief valve spring for a collapsed or worn condition.

Check the relief valve spring tension. If the spring tension is not within specifications and/or the spring is defective, replace the spring.

Check the relief valve piston for scores and free operation in the bore.

**Inspection—Gear-Type Oil Pump.** Inspect the pump body and the gear teeth for damage or wear. Check the gear end clearance with a dial indicator or Plastigage. The Plastigage method is as follows:

Position the gasket on the housing, then place the Plastigage on the gears and install the cover. Remove the cover and check the Plastigage reading.

Check the gears for freedom of rotation. Check the compression of the oil pressure relief valve spring and check the clearance of the relief valve in the valve chamber.

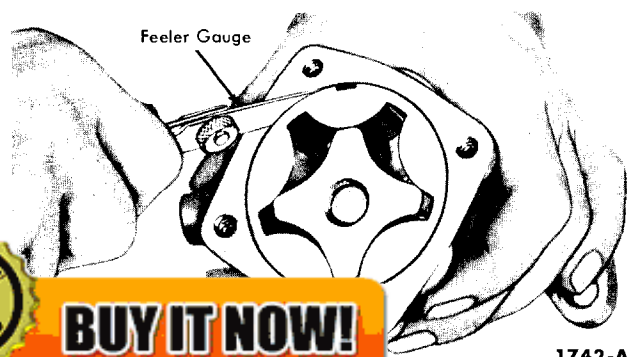

1742-A

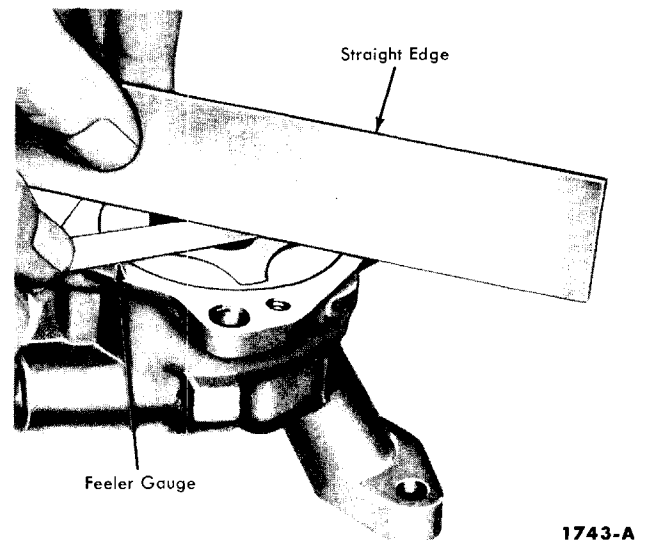

1743-A

FIG. 30—Rotor End Play—Rotor-Type Oil Pump

**100% SATISFACTION GUARANTEED**

**BUY IT NOW!**

**Click Here To Order**

PayPal, American Express, Discover, MasterCard, VISA

# PART

## 1-2

# MILEAGE MAKER SIX

Section	Page
5 Engine Assembly (Engine Removed).....	1-34
6 Repair Operations (Engine Installed).....	1-39
Engine Supports.....	1-39
Manifolds.....	1-40
Exhaust Gas Control Valve Replacement.....	1-41
Cylinder Head.....	1-41
Crankshaft Damper.....	1-42
Cylinder Front Cover and Timing Chain.....	1-42
Camshaft.....	1-43
Tappet Replacement.....	1-43
Flywheel.....	1-43
Oil Filter Replacement...	1-43
Oil Pan and Oil Pump...	1-44

Section	Page	Section	Page
1 Description.....	1-25	4 Disassembly and Assembly of Component Parts (Cont.)	
2 Engine Removal and Installation.....	1-28	Valve Rocker Arm Shaft Assembly.....	1-32
3 Engine Disassembly (Engine Removed).....	1-29	Cylinder Head.....	1-32
4 Disassembly and Assembly of Component Parts.....	1-32	Pistons and Connecting Rods.....	1-33
		Oil Pump.....	1-34

### 1 DESCRIPTION

The Mileage Maker Six (Figs. 1 and 2) is a 6-cylinder engine with a piston displacement of 223 cubic

inches and a compression ratio of 8.4:1. The engine is available in all car models except the Skyliner. The

patent plate identification symbol is "A."

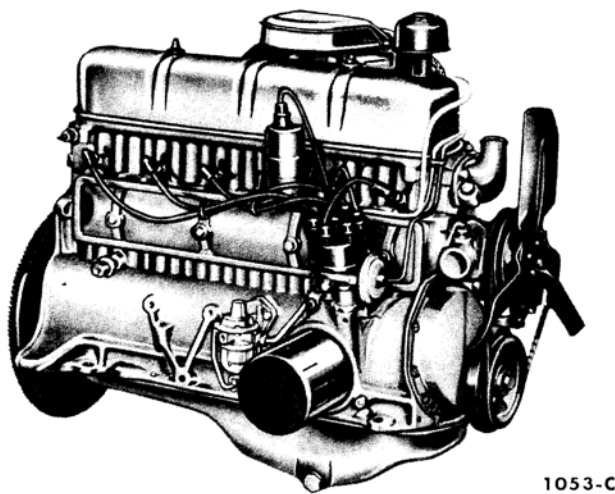

1053-C

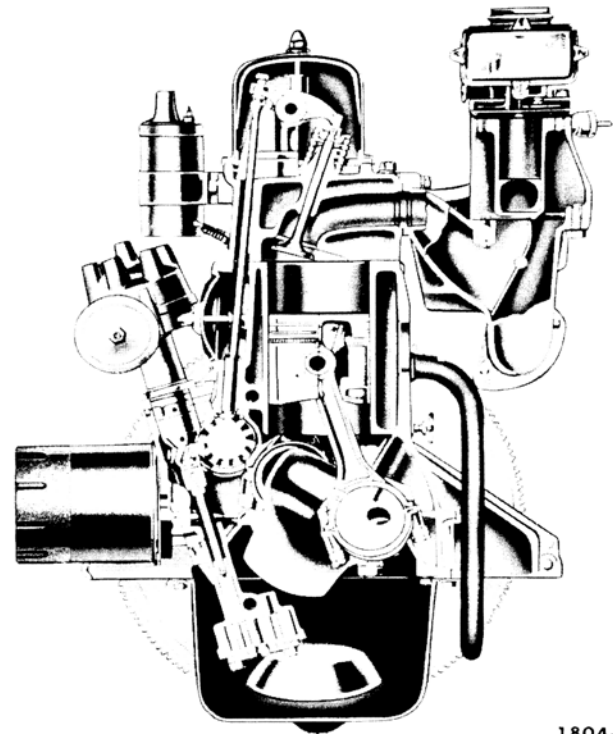

1804-A

FIG. 1—Mileage Maker Six—Right Front View

FIG. 2—Mileage Maker Six—Sectional View

#### MANIFOLDS

A chamber (heat riser) is cast into the intake manifold center section between the carburetor and exhaust manifold. A thermostatically controlled valve, located in the exhaust manifold (Fig. 3), directs exhaust gases into this area to provide the heat necessary to assist in vaporizing the incoming fuel mixture.



1002-A

**100% SATISFACTION GUARANTEED**

**BUY IT NOW!**

**Click Here To Order**

PayPal    American Express    Discover    MasterCard    VISA

### CYLINDER HEAD

The cylinder head carries the valves, valve rocker arm shaft assembly, manifold assembly, ignition coil, the water outlet, and thermostat. Valve guides are cast integral in the head. The valves are arranged from front to rear E-I-I-E-I-E-E-I-E-I-E.

### CYLINDER BLOCK

The cylinders are numbered from 1-6 starting at the front of the engine. The firing order is 1-5-3-6-2-4.

The oil pump, mounted inside the oil pan near the front, is driven by the distributor through an intermediate drive shaft. The distributor is located on the right side of the engine near the front.

The crankshaft is supported by four insert-type main bearings. Crankshaft end thrust is controlled by the flanges of the No. 3 main bearing.

The pistons have two compression rings and one oil control ring.

The top compression ring is chrome-plated and the lower compression ring is phosphate-coated. The oil control ring assembly consists of a serrated spring and two chrome-plated steel rails.

### VALVE TRAIN

The intake and exhaust valve assemblies are the rotating-type which rotate each time the valve opens and closes.

The push rods are one-piece tubular steel with oil cushioned sockets. The tappets are the solid steel, mushroom-type. Valve lash is maintained by self-locking adjusting screws.

The camshaft is supported by four insert-type bearings pressed into the block and is driven by a sprocket and timing chain in mesh with a sprocket on the crankshaft. Camshaft thrust is controlled by a thrust plate located between the camshaft sprocket and the front journal of the camshaft. An eccentric, made

integral with the camshaft, operates the fuel pump.

### LUBRICATION SYSTEM

Oil from the oil pan sump is forced through the pressure-type lubrication system (Fig. 4) by a gear-type pump. A spring loaded relief valve in the pump limits the maximum pressure of the system. Oil relieved by the valve is directed back to the intake side of the pump.

All the oil discharged by the pump passes through a full flow-type filter before it enters the engine. The filter has an integral relief valve and mounting gasket. The relief valve permits oil to bypass the filter if it becomes clogged, thereby maintaining an emergency supply of oil to the engine at all times. An anti-drain back diaphragm prevents a reverse flow of oil when the engine is stopped.

From the filter, the oil flows into the main oil gallery. The oil gallery supplies oil to all the camshaft and

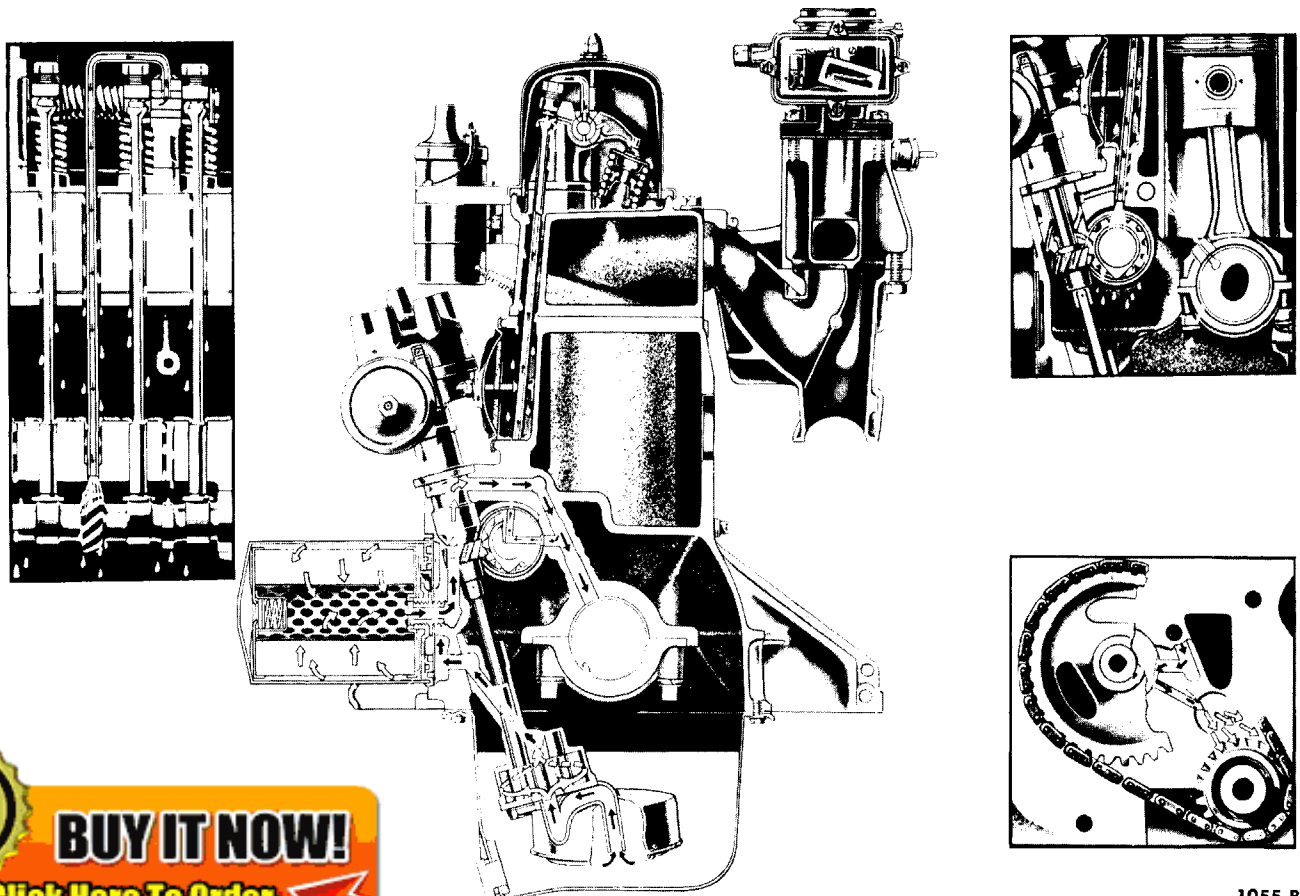

**100% SATISFACTION GUARANTEED**

**BUY IT NOW!**

**Click Here To Order**

PayPal American Express Cards Discover NOVUS MasterCard VISA

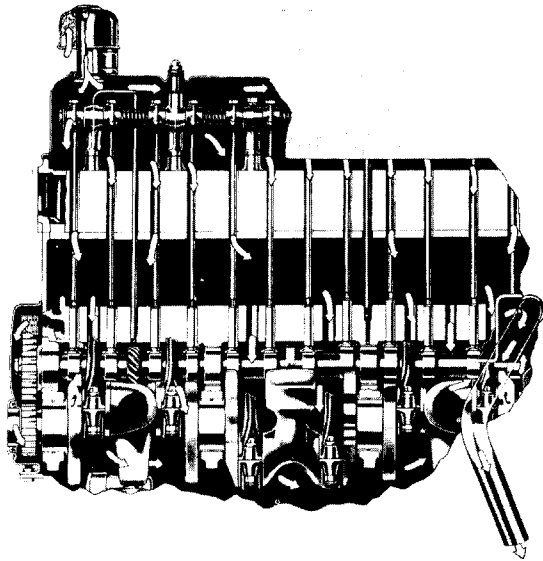

1057-B

FIG. 5—Crankcase Ventilation System

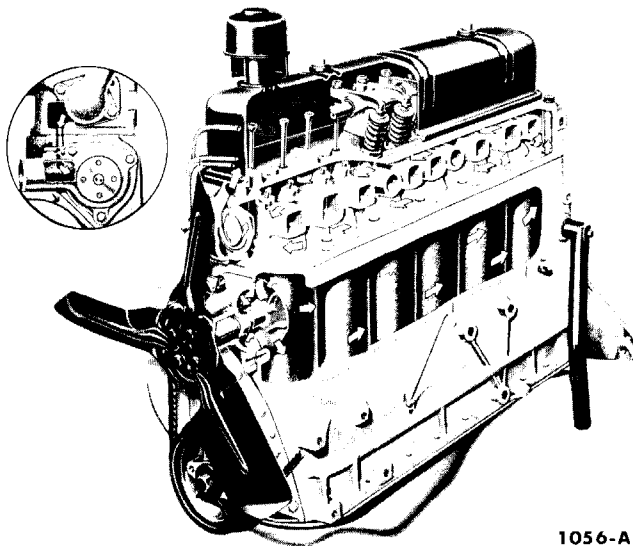

1056-A

FIG. 6—Cooling System

main bearings through a drilled passage in each main bearing web.

The timing chain and sprockets are lubricated through a flat on the No. 1 camshaft bearing.

Oil slingers are provided to prevent leakage by directing oil away from the crankshaft front and rear

to the valve rocker arm shaft assembly through a drilled passage in the cylinder block at the No. 3 camshaft bearing which indexes with a hole in the cylinder head. An oil inlet tube directs the oil into the hollow rocker shaft through the No. 6 valve rocker arm support. The oil from the shaft flows through drilled holes in each rocker arm to lubricate the rocker arm bushing and the valve and ball end of the rocker arm. The excess oil spirals down the rotating push rod and assists in lubricating the tappet and push rod seat. An oil outlet tube exhausts

excess oil from the rocker shaft to lubricate the distributor lower bushing and distributor drive gears. The oil outlet tube is located at the No. 1 rocker arm support. The oil from each rocker arm drains into the push rod chamber through holes provided in the cylinder head.

The oil in the push rod chamber drains back into the oil pan through an opening at the back of the block.

### CRANKCASE VENTILATION

Ventilating air (Fig. 5) is provided by the combination oil filler and breather cap located on the front of the valve rocker arm cover. The oil filler cap contains a maze filtering element.

From the filler cap, the filtered air flows into the front section of the valve rocker arm shaft chamber. There are relatively few contaminating vapors at this point and the air has a chance to normalize its temperature before contacting contaminating vapors originating in the crankcase. This warm ventilating air minimizes the formation of crankcase sludge. The ventilating air moves down past the push rods into the crankcase. Air is diverted from the front section of the crankcase through holes in the front of the cylinder block wall to ventilate the timing chain chamber. The air from the crankcase is then directed into the crankcase ventilation tube by the rotating action of the crankshaft.

### COOLING SYSTEM

The coolant is drawn from the bottom of the radiator by the water pump which delivers the coolant to the cylinder block (Fig. 6).

As the coolant enters the block, it travels through cored passages to cool the entire length of each cylinder wall. Upon reaching the rear of the cylinder block, the coolant is directed upward into the cylinder head where it cools the combustion chambers, valves, and valve seats on its return to the front of the engine.

At this point, the coolant flows into the water outlet connection, past the water thermostat if it is open, into the top of the radiator. If the thermostat is closed, a small portion of the coolant is returned to the water pump for recirculation. The entire system is pressurized to 13-15 psi with the use of a pressure-type radiator cap.

**100% SATISFACTION GUARANTEED**

**BUY IT NOW!**

**Click Here To Order**

Crankshaft

PayPal

MasterCard

VISA

## 2 ENGINE REMOVAL AND INSTALLATION

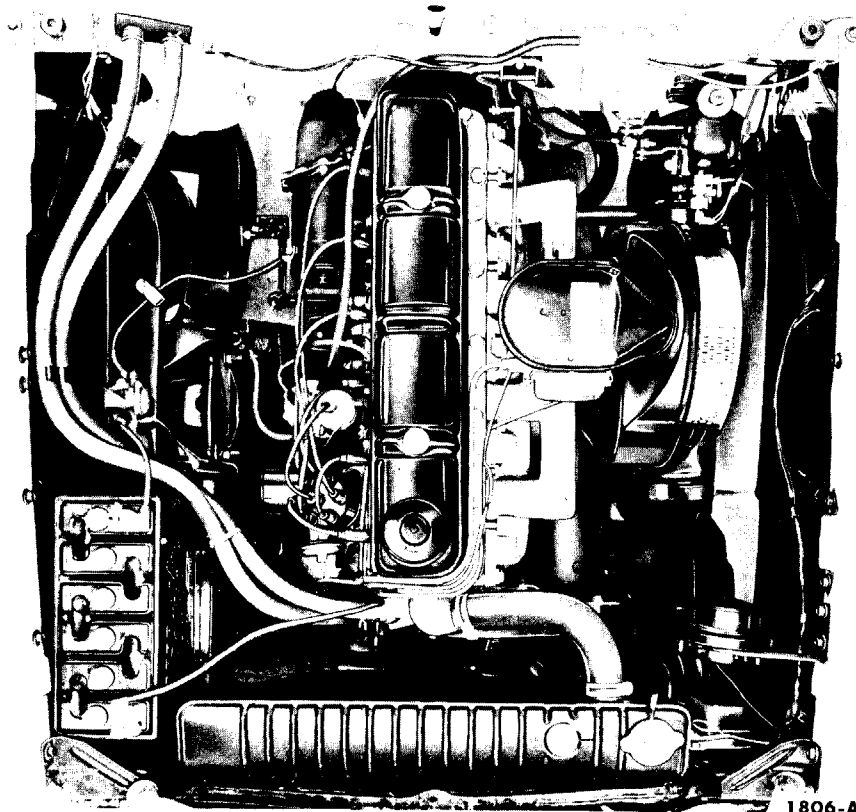

FIG. 7—Mileage Maker Six Installation

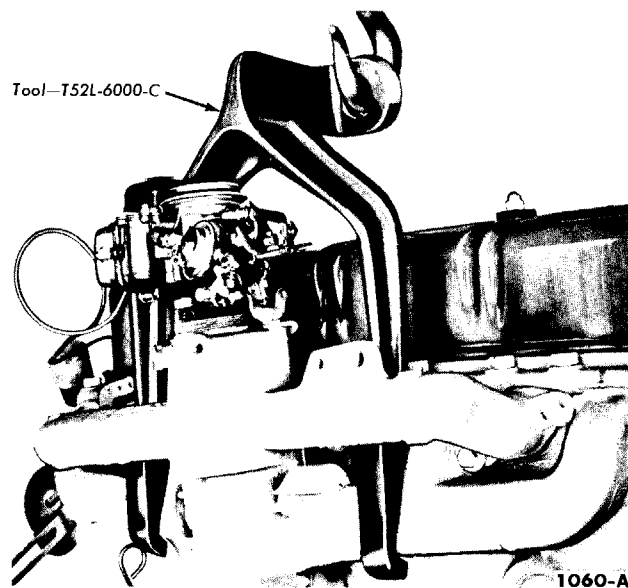

FIG. 8—Engine Lifting Hook

cable at the battery, the heater hoses at the water pump and water outlet housing, and the vacuum hose and flexible fuel line at the fuel pump.

3. Disconnect the primary wire at the coil, the oil pressure and temperature sending unit wires at the sending units, and the starter cable at the starter.

4. Remove the starter (and the automatic transmission fluid filler tube bracket). Remove the engine rear plate upper right bolt.

5. Remove the radiator. Remove the air cleaner, then tape the air horn closed.

6. Disconnect the accelerator retracting spring and the accelerator rod assembly at the carburetor.

7. On a car with an automatic transmission, remove the accelerator bracket from the intake manifold, then tie the bracket to the dash panel.

On a car with a manual-shift transmission, disconnect the clutch release spring and rod.

8. Disconnect the choke control cable at the carburetor, the generator wires at the generator, and the engine ground strap at the converter housing or flywheel housing.

9. Disconnect the exhaust manifold from the muffler inlet pipe.

10. On a car with an automatic transmission, remove the flywheel housing access cover. Remove the flywheel to converter nuts and bolts, then secure the converter assembly in the housing.

On a car with a manual-shift transmission, remove the flywheel housing inspection cover.

11. Remove the flywheel housing to engine bolts. Support the transmission with a jack.

12. Remove the engine right and left support bracket to engine bolts.

13. Attach the engine lifting hook (Fig. 8). Raise the engine slightly, then carefully pull it from the transmission. Lift the engine out of the chassis, then install it on a work stand (Fig. 9).

### REMOVAL

1. Drain the cooling system and the crankcase.
2. Disconnect the battery ground

**100% SATISFACTION GUARANTEED**

**BUY IT NOW!**

Click Here To Order

ent be ns-

PayPal American Express Discover/Novus MasterCard VISA

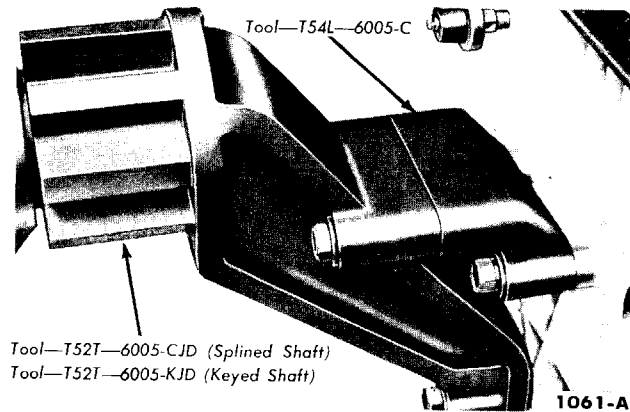

**FIG. 9—Engine Mount**

#### INSTALLATION

1. Place a new gasket over the exhaust manifold to muffler inlet pipe studs.

2. Lower the engine carefully into the chassis. Make sure the studs on the exhaust manifold are aligned with the holes in the muffler inlet pipe and the dowels in the block engage the holes in the flywheel housing.

3. On a car with an automatic transmission, start the converter pilot into the crankshaft. Install the engine to flywheel housing bolts. Tighten the bolts to specifications. Remove the jack supporting the transmission. Remove the retainer securing the converter in the housing, then install the flywheel to converter nuts and bolts and tighten them to specifications. Install the flywheel housing lower access cover

and the flywheel housing cover assembly.

4. On a car with a manual-shift transmission, start the transmission main drive gear into the clutch disc. It may be necessary to adjust the position of the transmission with relation to the engine if the transmission input shaft will not enter the clutch disc. **If the engine “hangs up” after the shaft enters, turn the crankshaft slowly (with the transmission in gear) until the shaft splines mesh with the clutch disc splines.** Install the flywheel housing bolts and tighten them to specifications. Install the flywheel housing inspection cover. Remove the jack supporting the transmission.

5. Install the engine left and right support bracket to engine bolts, then tighten the bolts to specifications.

6. Install the starter (and automatic transmission fluid filler tube bracket).

7. Install the engine rear plate upper right retaining bolt. Connect the starter cable, the coil primary wire, the oil pressure and temperature sending unit wires, the vacuum hose and flexible fuel line, the heater hoses, and the battery ground cable.

8. Install the exhaust manifold to muffler inlet pipe lockwashers and nuts, then tighten the nuts to specifications. Connect the engine ground strap, the generator wires, and the choke control cable.

9. On a car with an automatic transmission, install the accelerator bracket on the intake manifold.

On a car with a manual-shift transmission, connect the clutch release spring and rod. Adjust the clutch pedal free travel.

10. Connect the accelerator retracting spring and the accelerator rod assembly. Adjust the throttle linkage. Remove the tape from the carburetor air horn.

11. Install the radiator. Fill and bleed the cooling system. Fill the crankcase.

12. Install the air cleaner. Operate the engine at fast idle and check all hose connections and gaskets for leaks.

### 3 ENGINE DISASSEMBLY (ENGINE REMOVED)

Make sure that all the oil and coolant has been drained from the engine.

#### MANIFOLDS

Connect the distributor vac-

uum line from the head. Remove the gaskets and sleeves.

3. Remove the nuts and bolt joining the intake and exhaust manifolds, then separate the manifolds.

#### CYLINDER HEAD

1. Disconnect the fuel inlet line at the fuel pump, and the distributor vacuum line at the distributor, then remove the two lines as an assembly.

2. Disconnect the high tension

lead at the coil, then remove the coil from the cylinder head. Disconnect the spark plug wires at the spark plugs, then remove the distributor cap and spark plug wires as an assembly. Remove the spark plugs.

3. Remove the valve rocker arm cover. Remove the cap screw and bracket from the No. 6 rocker arm support. Pull the oil inlet line out of the support, then pull it out of

100% SATISFACTION GUARANTEED

**BUY IT NOW!**

Click Here To Order

PayPal | American Express | Discover | MasterCard | VISA

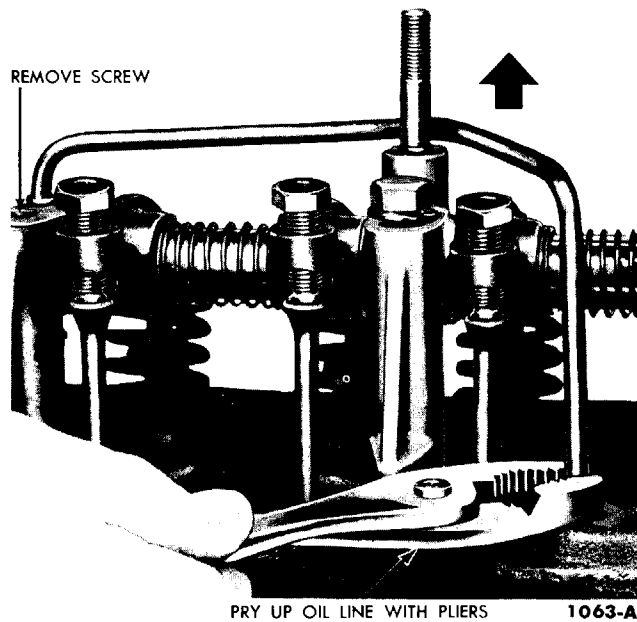

FIG. 10—Oil Inlet Line Removal

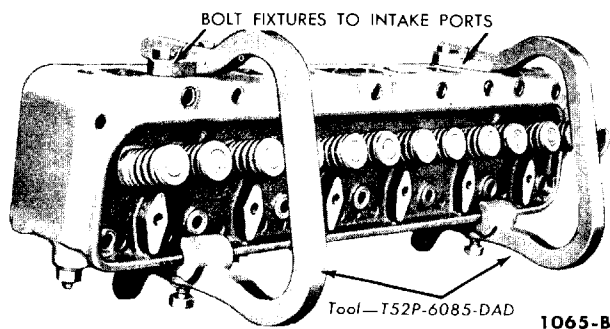

FIG. 12—Cylinder Head Holding Fixture

the block with pliers (Fig. 10). Be careful not to damage the line.

4. Remove the cap screw from the No. 1 rocker arm support, then remove the oil outlet line and bracket.

5. Loosen all rocker arm adjusting screws to remove the valve spring load from the rocker arms, then remove the valve rocker arm shaft assembly.

6. Remove the valve push rods in sequence and identify them so they can be installed in their original positions (Fig. 11).

7. Install the cylinder head holding fixtures for convenience in lifting the head and to protect the

### OIL FILTER, FUEL PUMP, AND DISTRIBUTOR

Unscrew the oil filter from the block. Remove the fuel pump and gasket, and the distributor and intermediate drive shaft. Remove the oil level dipstick and the valve push rod cover.

### FLYWHEEL

1. On a flywheel for a manual-shift transmission, mark the pressure plate cover so that it can be replaced in the same position, and remove the clutch pressure plate and cover assembly.

2. Remove the flywheel retaining bolts and remove the flywheel.

### OIL PAN AND OIL PUMP

1. Invert the engine on the work stand.

2. Remove the oil pan retaining

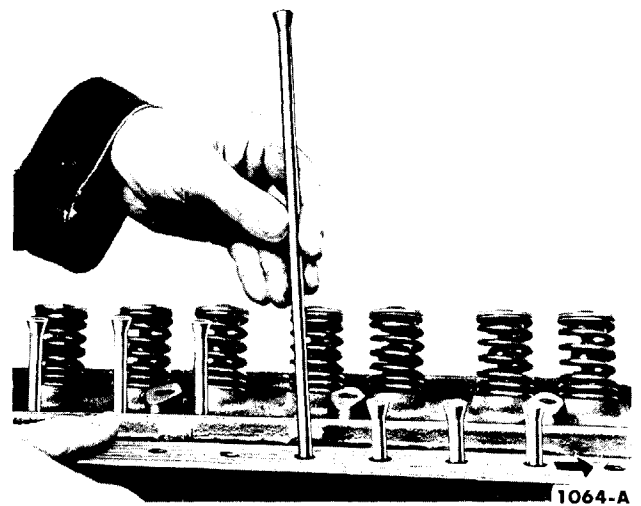

FIG. 11—Valve Push Rod Removal

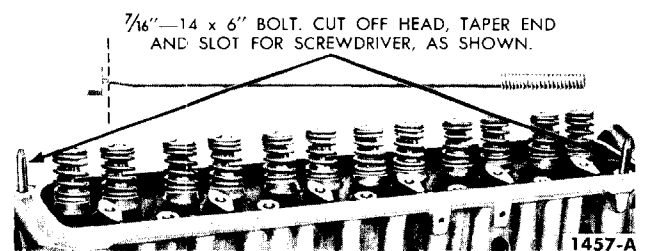

FIG. 13—Cylinder Head Guide Studs

screws and remove the oil pan. Discard the gasket.

3. Remove the oil pump attaching nuts and lockwashers, then remove the oil pump and inlet tube assembly. Discard the oil pump gasket.

### CYLINDER FRONT COVER

1. Loosen the generator mounting bolts and disconnect the generator adjusting arm at the water pump. Remove the drive belt(s). Remove the fan and pulley. Remove the generator, and the water pump.

2. Remove the cap screw and washer from the end of the crankshaft. Install the puller on the crankshaft damper, then remove the damper (Fig. 14).

3. Remove the screws fastening the cylinder front cover to the block, then remove the cylinder front cover. Discard the gasket.

### TIMING CHAIN AND SPROCKETS

Remove the crankshaft front oil slinger. Remove the camshaft

**100% GUARANTEED**

**BUY IT NOW!**

**Click Here To Order**

PayPal, American Express, Discover, MasterCard, VISA



**BUY IT NOW!**

**Click Here To Order**



PayPal

Discover  
Cards

DISCOVER  
NEWUS

MasterCard

VISA

**FORD DIVISION**  
**FORD MOTOR COMPANY**