

1 9 5 6 - 5 7

# FORDOMATIC

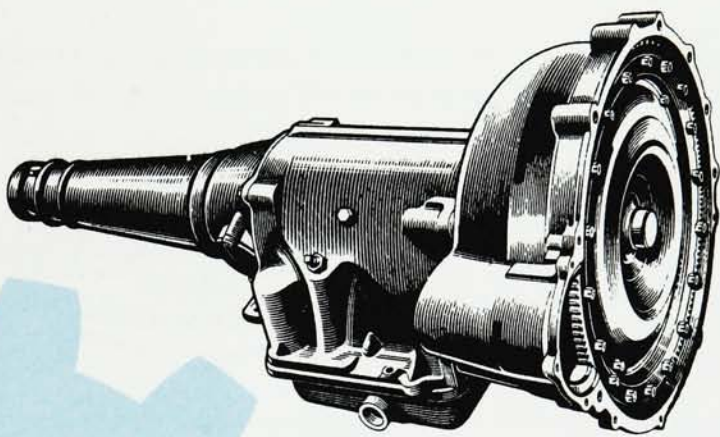

*Shop  
Manual*

**FORD  
CAR-TRUCK**



**BUY IT NOW!**

**Click Here To Order**



**FORD MOTOR COMPANY**

Copyright © 2010, Forel Publishing Company, LLC, Woodbridge, Virginia

All Rights Reserved. No part of this book may be used or reproduced in any manner whatsoever without written permission of Forel Publishing Company, LLC. For information write to Forel Publishing Company, LLC, 3999 Peregrine Ridge Ct., Woodbridge, VA 22192

## **1956-57 Fordomatic Shop Manual**

**EAN: 978-1-60371-019-0**

**ISBN: 1-60371-019-1**

Forel Publishing Company, LLC

3999 Peregrine Ridge Ct.

Woodbridge, VA 22192

Email address: [webmaster@ForelPublishing.com](mailto:webmaster@ForelPublishing.com)

Website: <http://www.ForelPublishing.com>



This publication contains material that is reproduced and distributed under a license from Ford Motor Company. No further reproduction or distribution of the Ford Motor Company material is allowed without the express written permission of Ford Motor Company.

---

## **Note from the Editor**

This product was created from the original Ford Motor Company's publication. Every effort has been made to use the original scanned images, however, due to the condition of the material; some pages have been modified to remove imperfections.

---

## **Disclaimer**

Although every effort was made to ensure the accuracy of this book, no representations or warranties of any kind are made concerning the accuracy, completeness or suitability of the information, either expressed or implied. As a result, the information contained within this book should be used as general information only. The author and Forel Publishing Company, LLC shall have neither liability nor responsibility to any person or entity with respect to any loss or damage caused, or alleged to be caused, directly or indirectly by the information contained in this book. Further, the publisher and author are not engaged in rendering legal or other professional services. If legal, mechanical, electrical, or other expert assistance is required, the professional should be sought.



## FOREWORD

*This manual contains complete service information for all Fordomatic transmissions used in the 1956 and 1957 Ford Cars, Thunderbird, and Trucks. All the procedures and specifications needed to check, adjust, replace, or repair the various parts and assemblies of each transmission and torque converter are included.*

*In many cases, the service procedures are accompanied by illustrations showing the parts and the operations being performed. Wherever special tools are needed to service a unit, illustrations show the use of the tools. Disassembled views of some of the transmission assemblies are also shown to aid in identifying the various parts and their relative position in the assemblies.*

*Where new procedures are introduced for the first time on the 1957 Fordomatic, they also apply to the 1956 model.*

*The descriptions and specifications contained in this manual were in effect at the time the book was approved for printing. The Ford Division of Ford Motor Company reserves the right to discontinue models at any time, or change specifications or design, without notice and without incurring obligation.*

SERVICE DEPARTMENT  
**FORD DIVISION**  
FORD MOTOR COMPANY



# TABLE OF CONTENTS

Subject	Page
<b>Chapter ONE—CONSTRUCTION AND OPERATION</b> .....	3
Section 1 Torque Converter .....	3
2 Planetary Gear Train .....	6
3 Clutches, Bands and Servos .....	7
4 Control System .....	9
 <b>Chapter TWO—MAINTENANCE AND ADJUSTMENTS</b> .....	 16
Section 1 Transmission Fluid .....	16
2 Adjustments .....	17
 <b>Chapter THREE—TROUBLE SHOOTING</b> .....	 22
Section 1 Preliminary Checks .....	22
2 Performance Checks .....	23
3 Final Diagnosis .....	28
 <b>Chapter FOUR—REPLACEMENT</b> .....	 30
Section 1 Sub-Assemblies—Transmission in Vehicle .....	30
2 Transmission and Converter .....	33
3 Transmission without Converter .....	35
 <b>Chapter FIVE—TRANSMISSION OVERHAUL</b> .....	 37
Section 1 Removal of Sub-Assemblies .....	37
2 General Inspection .....	40
3 Repair and Assembly of Sub-Assemblies .....	41
4 Transmission Case and Linkage .....	53
5 Installation of Sub-Assemblies .....	54
6 Hydraulic System Tests—Transmission on Bench .....	57
 <b>Chapter SIX—CONVERTER OVERHAUL</b> .....	 60
Section 1 Converter Removal .....	60
2 Disassembly .....	60
3 Inspection .....	61
4 Assembly .....	62
5 Installation .....	63
 <b>Chapter SEVEN—DIAGNOSIS AND TOOLS</b> .....	 64



**BUY IT NOW!**

**Click Here To Order**



## Chapter ONE

# CONSTRUCTION AND OPERATION

Section		Page
1	Torque Converter .....	3
2	Planetary Gear Train .....	6
3	Clutches, Bands, and Servos .....	7
4	Control System .....	9

Fordomatic transmissions are available, as optional equipment, for all 1956 and 1957 Ford cars, including the Police Interceptor Unit, Station Wagons, Courier, Ranchero and Thunderbird, and F-100, F-250, F-350, P-350, P-400 and P-500 trucks. The units are basically the same as previous Fordomatic models. However, changes have been made to compensate for the increased engine horsepower in 1956 and 1957 cars and trucks.

The Fordomatic transmission combines a hydraulic

torque converter with a fully-automatic gear system (Fig. 2), and provides a wide range of transmission ratios.

The construction details and the principles of operation of the major assemblies in the transmission are described in this chapter. Any Fordomatic design or operational differences that may exist among the various car and truck models are also fully explained here.

## I. TORQUE CONVERTER

The hydraulic torque converters used with all 1956 and 1957 Fordomatic models differ in size. All 6-cylinder cars and trucks have an 11¾-inch converter. All 8-cylinder cars and trucks have a 12-inch converter.

### a. Construction.

The torque converter consists of three main parts: the impeller (pump), the turbine, and the stator (Fig. 1). The impeller is driven by the engine crankshaft through a spring-steel flywheel bolted to the engine crankshaft. The turbine, which is mounted on a shaft, is driven by the impeller. The stator is mounted on a one-way clutch. All of these parts are enclosed in a fluid-filled housing which is part of the impeller.

The impeller, or driving member, consists of curved blades mounted around the inside of a housing which is driven by the engine. An inner ring locks the blades in place and forms a fluid passage. As the impeller rotates, fluid is thrown through the curved fluid passage into the turbine.

The turbine, or driven member, is similar to the impeller except that it has blades curved in the opposite direction to the impeller blades. Fluid from the impeller strikes the turbine blades and causes the turbine and

case by a one-way clutch which permits the stator to rotate only in the same direction as the impeller. The clutch locks the stator to the support on the case to prevent backward rotation.

The power from the turbine is transmitted to the transmission through the turbine shaft.

### b. Operation.

The torque converter is designed so that the fluid flows from the impeller to the turbine and back to the impeller through the stator. This flow produces a maxi-

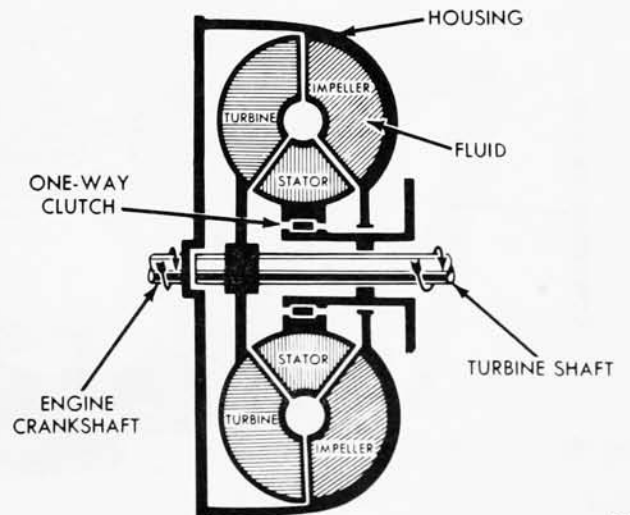
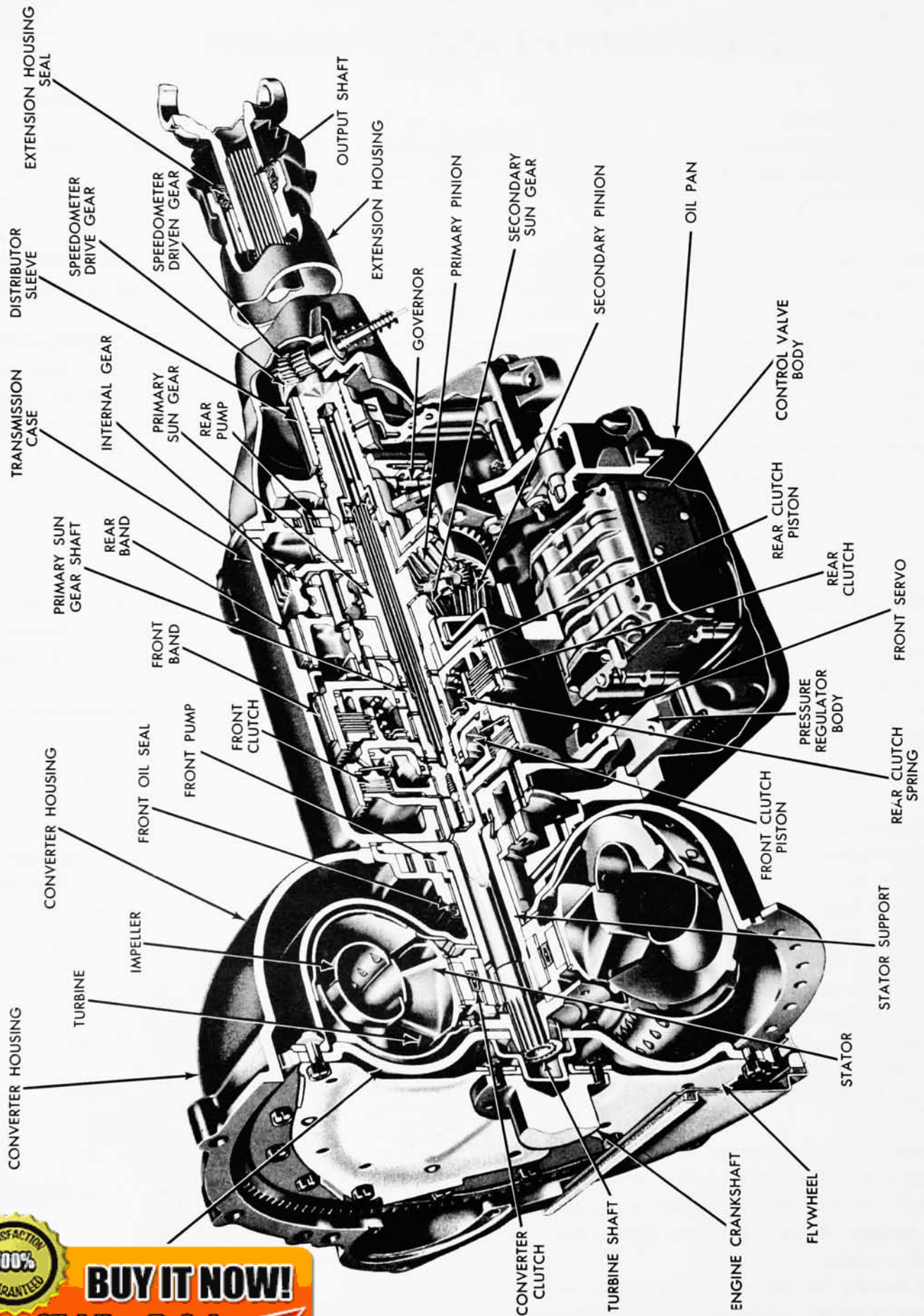

Fig. 1—Torque Converter Parts

**100% SATISFACTION GUARANTEED**

**BUY IT NOW!**

[Click Here To Order](#)



3136-A

Fig. 2—Fordomatic Transmission Assembly

**100% SATISFACTION GUARANTEED**

**BUY IT NOW!**

**Click Here To Order**

imum torque increase of slightly over 2:1 when the turbine is stalled. When enough torque is developed by the engine and converter, the turbine begins to rotate, turning the turbine shaft.

The converter torque multiplication gradually tapers off as turbine speed approaches impeller speed and becomes 1:1 when the turbine is being driven at 9/10 impeller speed. This is known as the "coupling point."

While the turbine is operating at less than 9/10 impeller speed and the converter is multiplying torque, the fluid leaving the turbine blades strikes the front face of the stator blades. These blades are held stationary by the action of the one-way clutch as long as the fluid is directed against the front face of the blades.

When the turbine rotates faster than 9/10 impeller speed and the converter no longer multiplies torque, the fluid is directed against the back face of the stator blades. As the one-way clutch permits the stator to rotate only in the direction of impeller rotation, the stator begins to turn with the impeller and turbine. The converter now acts as an efficient fluid coupling as long as the turbine speed remains greater than 9/10 impeller speed.

The aluminum torque converter used on all 6-cylinder

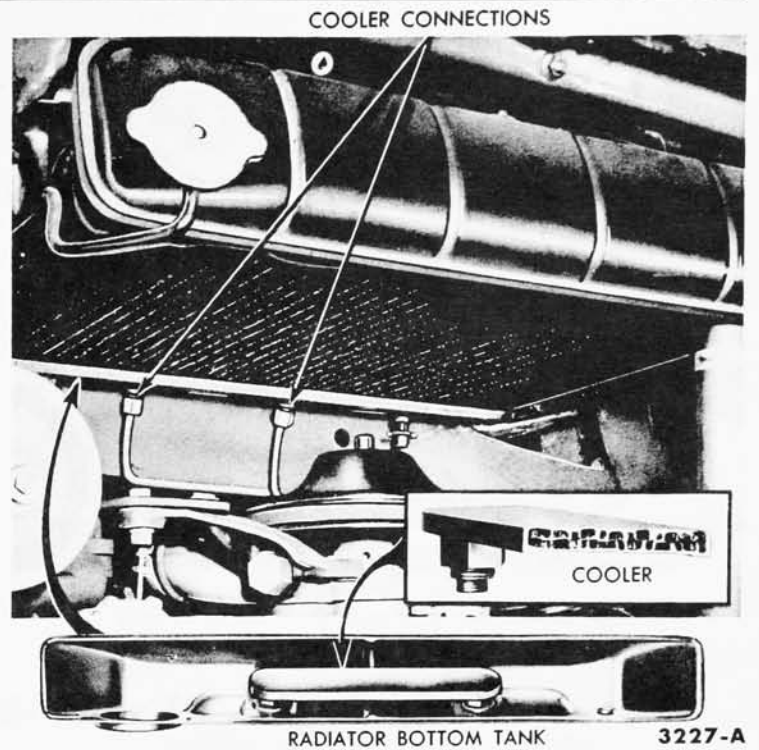

Fig. 4—Fluid Line Connection at Radiator—8-Cylinder Car

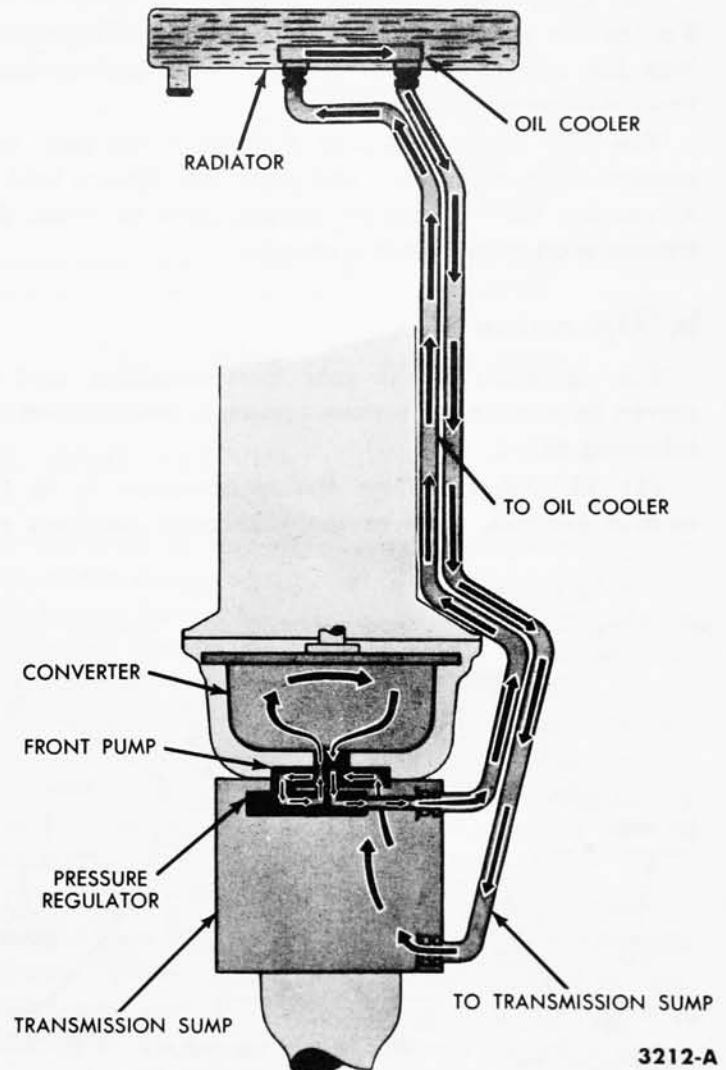

Fig. 5—8-Cylinder Car Fordomatic Cooling System (Schematic)



—6-Cylinder Car

**100% SATISFACTION GUARANTEED**

**BUY IT NOW!**

**Click Here To Order**

PayPal   American Express   Discover   MasterCard   VISA

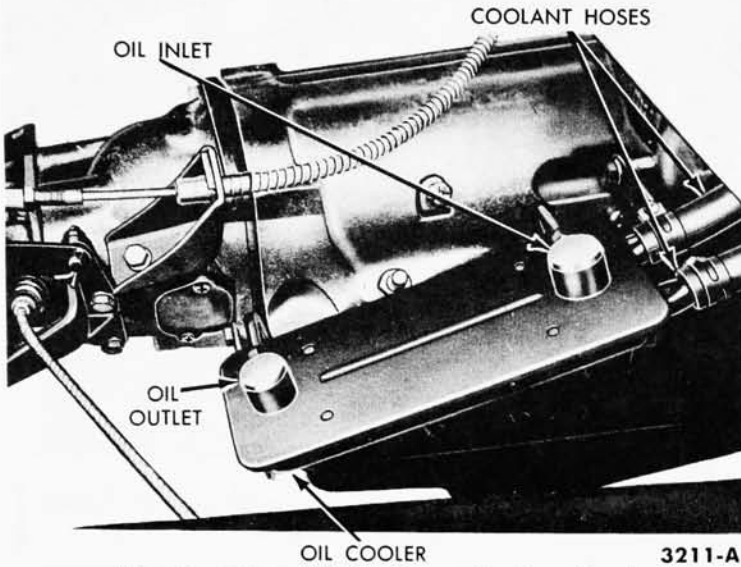

Fig. 6—Oil-to-Water-Type Cooler—Truck

(and early 1956 8-cylinder) engine is air cooled as shown in Fig. 3.

On trucks, the inlet duct is cast into the top of the converter housing. Fins on the outside of the impeller housing draw air in through a coarse screen, circulate it over the entire converter surface, and exhaust the air through an outlet on the side of the housing.

Cooling of the steel torque converter used on all 8-cylinder cars is accomplished by circulating the transmission fluid through an oil-to-water type cooler, located in the radiator lower tank as shown in Fig. 4 and schematically in Fig. 5.

On truck Fordomatic transmissions, except the 6-cylinder F-100, additional cooling is provided by an oil-to-water-type cooler (Fig. 6). Tubes connect the cooler with the transmission, and hoses connect the cooler with the engine cooling system.

## 2. PLANETARY GEAR TRAIN

### a. Construction.

The compound planetary gear system used in the Fordomatic transmission provides neutral, intermediate, high, low, and reverse gear ranges when certain combinations of gears are held or driven.

The gear train consists of a primary sun gear, secondary sun gear, primary and secondary pinions held in a common carrier, and an internal gear to which the transmission output shaft is attached.

### b. Operation

The operation of the gear train members, held or driven to provide the various ranges, is described on the following pages.

(1) **NEUTRAL.** When the transmission is in the neutral position, none of the gear train members are

held or driven. Therefore, no power is transmitted to the output shaft (Fig. 7).

(2) **INTERMEDIATE RANGE.** Intermediate range is accomplished by driving the primary sun gear and holding the secondary sun gear (Fig. 8). The primary pinions drive the secondary pinions causing them to “walk” around the secondary sun gear carrying the internal gear and output shaft around with them.

(3) **HIGH RANGE.** In high range, the primary and secondary sun gears are locked together and driven as a unit (Fig. 9). Therefore, the pinions cannot rotate and the entire planetary train revolves as a unit, which causes the output shaft to rotate at the same speed as the turbine shaft.

(4) **LOW RANGE.** In low range, the primary sun gear is driven and the pinion carrier is held (Fig. 10). Power is transmitted to the primary pinions, the second-

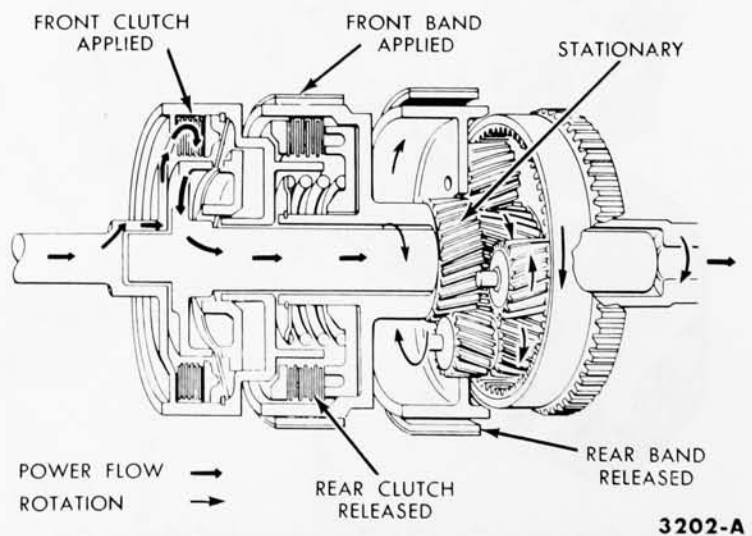

Fig. 8—Power Flow—Intermediate Range

**100% SATISFACTION GUARANTEED**

**BUY IT NOW!**

**Click Here To Order**

PC RO

PayPal American Express Discover Novus MasterCard VISA

Neutral Position

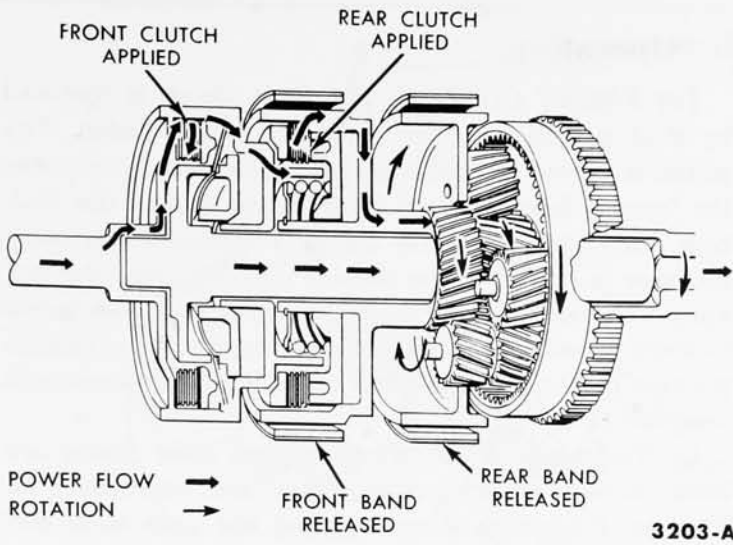

Fig. 9—Power Flow—High Range

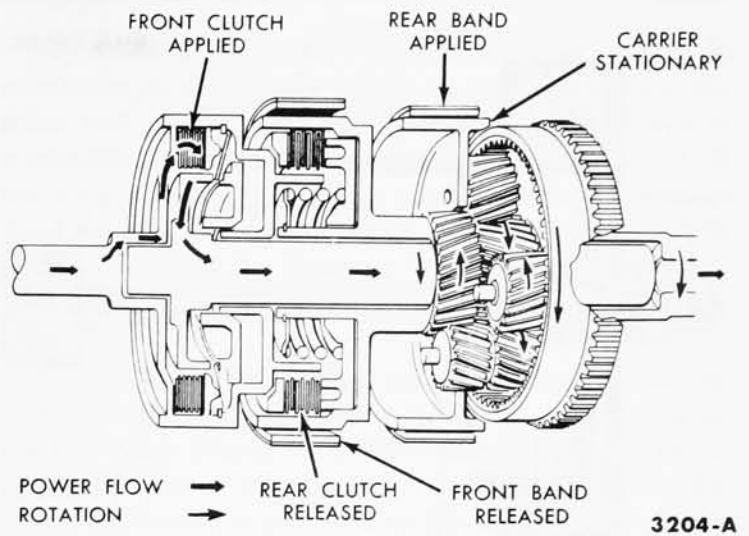

Fig. 10—Power Flow—Low Range

ary pinions, and the internal gear, driving the internal gear in the same direction as the primary sun gear. The secondary sun gear turns free in the reverse direction and has no effect on the gear train. The pinion carrier is held against rotation.

(5) **REVERSE RANGE.** Reverse range is accomplished by driving the secondary sun gear and holding the pinion carrier (Fig. 11). The secondary pinions drive the internal gear in the reverse direction. The primary sun gear and the primary pinions rotate freely and have no effect on the gear train.

(6) **PARK.** When the selector is in the P (park) position, the parking pawl engages the external teeth on the internal gear to lock the internal gear and output shaft. This locks the rear wheels to prevent movement of the vehicle.

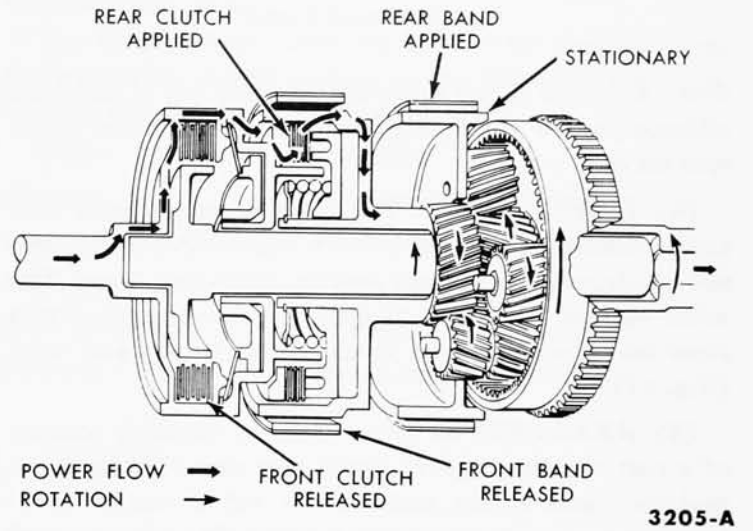

Fig. 11—Power Flow—Reverse Range

### 3. CLUTCHES, BANDS, AND SERVOS

A means of driving and holding the proper parts of the planetary gear train is required, in order to transmit power from the turbine and to obtain the various combinations required for the gear ratios. This is accomplished by the two multiple disc clutches and the two single wrapped bands shown in Fig. 2.

#### a. Construction.

(1) **FRONT CLUTCH.** The front clutch assembly on all models consists of the front clutch cylinder, front clutch piston, release spring, three steel drive plates and four clutch driven plates with bronze facings (Fig. 12). The drive plates are connected to the turbine shaft. The driven plates are connected to the primary sun gear

rear clutch drum, rear clutch piston, release spring, four steel clutch driven plates, and four clutch drive plates with bronze facings (Fig. 13). The Thunderbird, Police Interceptor, Station Wagons with 312 cu. in. engines, and cars with 8-barrel carburetors have 5 drive and 5 driven plates in the rear clutch. The rear clutch drive plates are connected to the hub of the front clutch drum and the four driven plates are connected to the drum of the secondary sun gear. A heavy release spring is used in the rear clutch assembly.

(3) **BANDS.** The front and rear bands are made of steel and have composition linings bonded to the inside surfaces. The front band encircles the drum of the secondary sun gear assembly. One end of the band is anchored in the transmission case and the other end is connected to the front servo.

The rear band fits around the planetary gear assembly

**100% SATISFACTION GUARANTEED**

**BUY IT NOW!**

**Click Here To Order**

PayPal    American Express    Discover    MasterCard    VISA

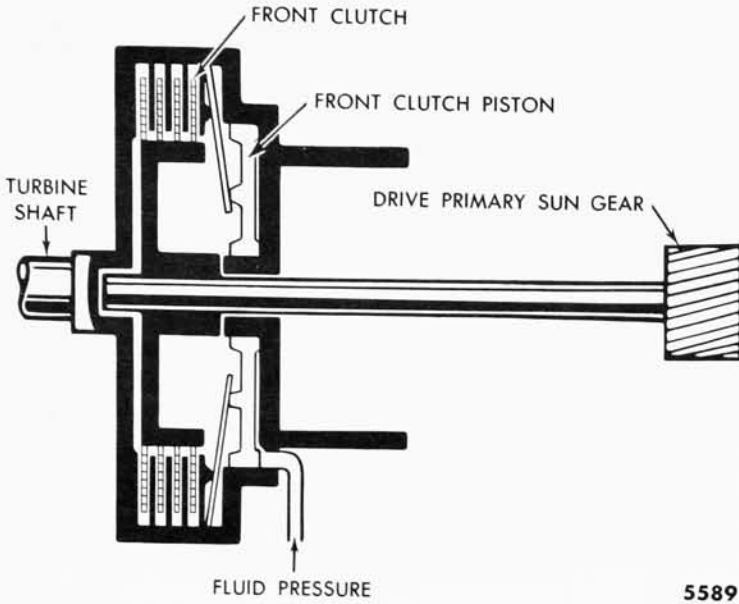
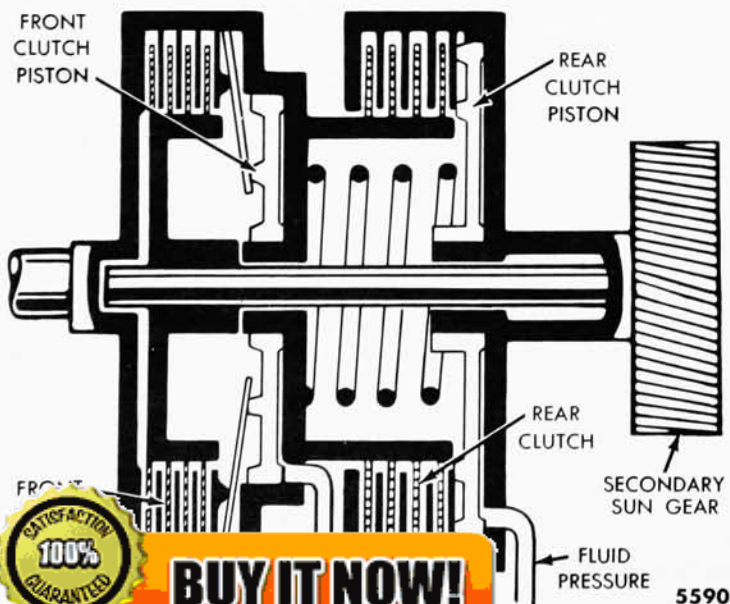

Fig. 12—Front Clutch

drum. One end of the band contacts the end of the band adjusting screw and the opposite end is connected to the rear servo.

(4) **FRONT SERVO.** The front servo assembly consists of an aluminum servo body, front servo piston, piston guide, release spring, and an actuating lever. The inner end of the lever contacts the front servo piston stem and the outer end contacts the front band strut (Fig. 14).

(5) **REAR SERVO.** The rear servo assembly consists of a cast aluminum servo body, rear servo piston, accumulator piston spring, accumulator piston, rear servo release spring, and an actuating lever. The inner end of the actuating lever contacts the accumulator piston and the outer end engages one end of the rear band strut. (Fig. 15.)



**100% SATISFACTION GUARANTEED**

**BUY IT NOW!**

**Click Here To Order**

**b. Operation.**

(1) **FRONT CLUTCH.** The front clutch is operated by fluid pressure against the front clutch piston. The piston is moved against a spring washer which increases the “apply” force through lever action to lock the multiple disc clutch. When the clutch is applied the primary sun gear is locked to the turbine shaft to drive the primary sun gear. The primary sun gear is driven in all forward speeds. The piston is returned to the release position by the spring washer when the fluid pressure is removed (Fig. 12).

In Neutral, front clutch drum and steel plates are being driven while bronze plates are stationary. In Reverse, the clutch is not applied but both steel and bronze plates are being driven at engine speed.

(2) **REAR CLUTCH.** The rear clutch is operated by fluid pressure against the rear clutch piston. Movement of the piston compresses the release spring and locks the multiple disc clutch. The rear clutch drive plates are splined to the front clutch drum and the driven plates are connected to the secondary sun gear. When the rear clutch is applied (in the reverse and in the drive range high ratios) the secondary sun gear is driven. The piston is returned to the released position by the rear clutch release spring (Fig. 13).

In Neutral, rear clutch bronze plates are being driven while steel plates are free. In Intermediate, rear clutch bronze plates are driven, but steel plates are held stationary. In Low, rear clutch bronze plates are driven clockwise at engine speed while steel plates are driven counterclockwise.

(3) **BANDS.** The front band encircles the drum of the secondary sun gear assembly. One end of the band is anchored against a boss in the transmission case. The opposite end of the band engages a strut between the band and front servo actuating lever. When the

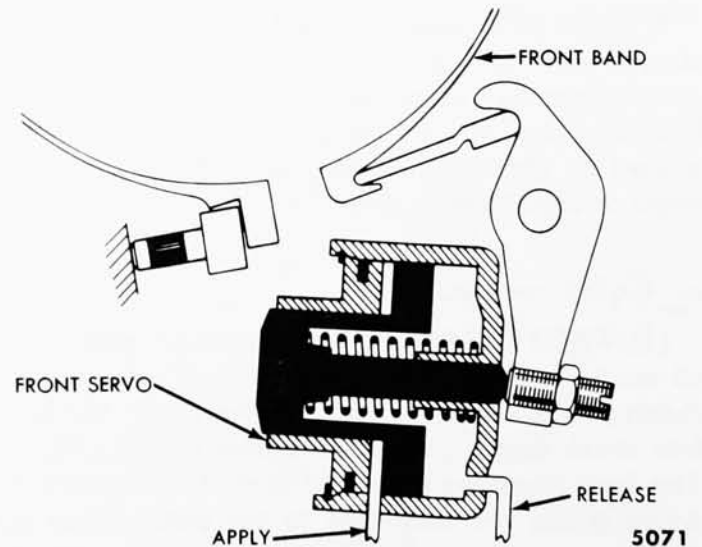

Fig. 14—Front Servo Operation

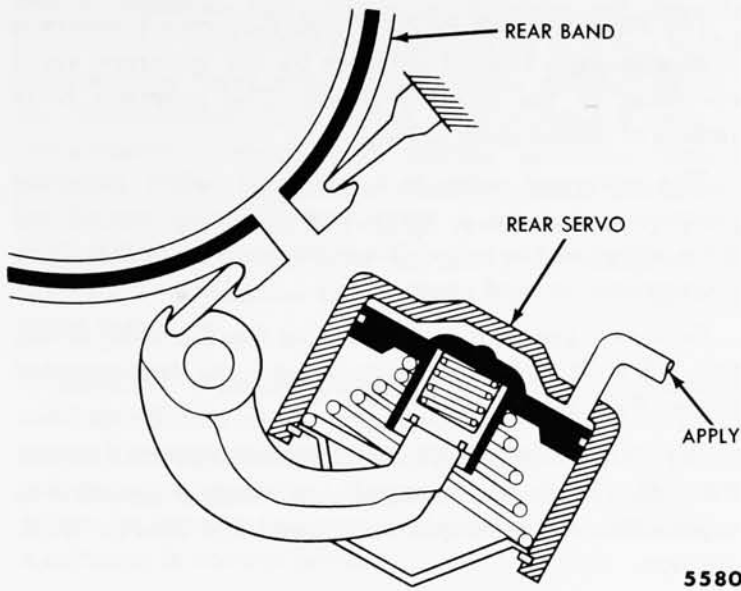

Fig. 15—Rear Servo Operation

band is held tightly around the drum, it prevents the secondary sun gear from turning. The front band is applied in the intermediate ratio.

The rear band is placed around a drum attached to the pinion carrier. One end of the rear band contacts a strut on the inner end of the rear band adjusting screw. The other end of the band engages the strut between the band and the rear servo actuating lever. The rear band is applied in the low and reverse ratios.

(4) **FRONT SERVO.** The front servo piston is moved by fluid pressure which exerts force against the inner end of the front servo actuating lever. Force is transmitted through a strut between the outer end of the lever and the end of the band to tighten the front band around the drum. Under certain conditions, the servo is released by directing fluid pressure to the opposite side of the piston, assisted by release spring force (Fig. 14).

(5) **REAR SERVO.** The rear servo assembly uses an accumulator piston and spring to cushion application of the rear band. Fluid pressure is directed to the rear servo piston to force it inward. When the band contacts the drum, cushioning is provided as the accumulator piston spring is compressed. As the accumulator piston bottoms in the rear servo piston bore, the rear band is fully applied (Fig. 15).

The clutches and bands are applied by pressure from the hydraulic control system in the following combinations to obtain the desired gear ranges:

Ratio	Apply
Neutral	No Clutches or Bands
Intermediate (1.47:1)	Front Clutch—Front Band
High (1:1)	Front Clutch—Rear Clutch
Low (2.40:1)	Front Clutch—Rear Band
Reverse (2:1)	Rear Clutch—Rear Band

## 4. CONTROL SYSTEM

Several fluid pressures, which vary with throttle opening, road speed or manual selector position, are used in the transmission control system. These fluid pressures and their operation under various driving conditions are explained in this section.

### a. Fluid Pressures.

(1) **PRESSURE SOURCE.** Two pumps (Fig. 17) deliver fluid pressure to the transmission control system. The front pump, driven by the converter impeller, operates whenever the engine runs. The rear pump, driven by the transmission output shaft, delivers fluid to the control system, when the vehicle moves forward.

The front pump has a greater capacity than the rear pump, since it must supply all the fluid to operate the transmission at low speeds and in reverse.

Both pumps deliver fluid pressure to the control pressure regulator and control valve body (Fig. 17). A regulated pressure, called control pressure, is available at the control valve body whenever the engine is running and the vehicle is in gear. The control pressure is approximately 15 psi.

Throttle pressure is used in the control system.

Throttle pressure is produced from control pressure by the throttle valve and is controlled by the compression on the throttle valve spring. Compression on the throttle valve spring is controlled by accelerator pedal depression.

Throttle pressure will vary from zero (at closed throttle) to the same pressure as maximum control pressure (at wide-open throttle), as shown in Figs. 16 and 19.

Throttle pressure is directed to the 2-3 valve and governor plug to oppose governor pressure, and thereby vary the 2-3 shift according to accelerator pedal depression.

Throttle pressure is also directed to the orifice control valve to position it for two 3-2 downshift conditions a downshift with closed throttle; a downshift with partial to full throttle.

(3) **MODULATED THROTTLE PRESSURE.** In Dr (drive) and Lo (low) a modulated throttle pressure (Fig. 17) is directed to the compensator valve to adjust compensator pressure to accelerator pedal depression (engine torque).

15

**100% SATISFACTION GUARANTEED**

**BUY IT NOW!**

**Click Here To Order**

adjust transmis-



In R (reverse) full throttle pressure is directed to two faces on the compensator valve to reduce compensator pressure, and thereby increase control pressure (Fig. 21). At 9½° to 12° transmission throttle lever advance in R (reverse), compensator pressure is reduced to zero, and thereby maximum control pressure is produced.

Maximum control pressure is not required or desirable in Dr (drive) or Lo (low); hence, throttle pressure in these ranges is directed to the modulator valve before it acts on one face of the compensator valve (Fig. 17).

The modulator valve has a spring of fixed length, and therefore fixed compression, attached to it. In operation the modulator valve permits throttle pressure to flow through it without a pressure reduction until throttle pressure reaches approximately 52 p.s.i. At this pressure, the modulator valve is balanced; hence, modulator pressure cannot exceed approximately 52 p.s.i.

(4) **SHIFT VALVE PLUG PRESSURE.** Before throttle pressure is admitted to the front facet of the 2-3 shift valve and the governor plug, it must open a passage past the spring-loaded shift valve plug (Fig. 17). Approximately 20 p.s.i. throttle pressure is required to move the plug against its spring far enough to open the passage; hence, the pressure past the plug is reduced.

(5) **GOVERNOR PRESSURE.** Governor pressure is produced from control pressure by the governor valve operating in the governor body. The governor body rotates at output shaft speed.

The governor valve is a balanced valve: governor pressure acting on a valve face balances centrifugal force acting on the valve. Governor pressure is therefore, proportional to road speed.

Governor pressure is directed to the 2-3 shift valve, the 1-2 shift valve (inhibitor), and the compensator valve (Figs. 17 and 19).

(6) **CONTROL PRESSURE AND COMPENSATOR PRESSURE.** In the transmission, control pressure is adjusted to engine torque, road speed and selector lever position.

To accomplish this, compensator pressure under various conditions is adjusted by throttle pressure (engine torque), governor pressure (road speed), or selector lever position. Compensator pressure, in turn, adjusts control pressure.

Basically, compensator pressure is regulated by the compensator valve spring. For example, with the engine idling (no throttle pressure) and the vehicle standing still (no governor pressure), compensator pressure is regulated only by the compensator valve spring. If the

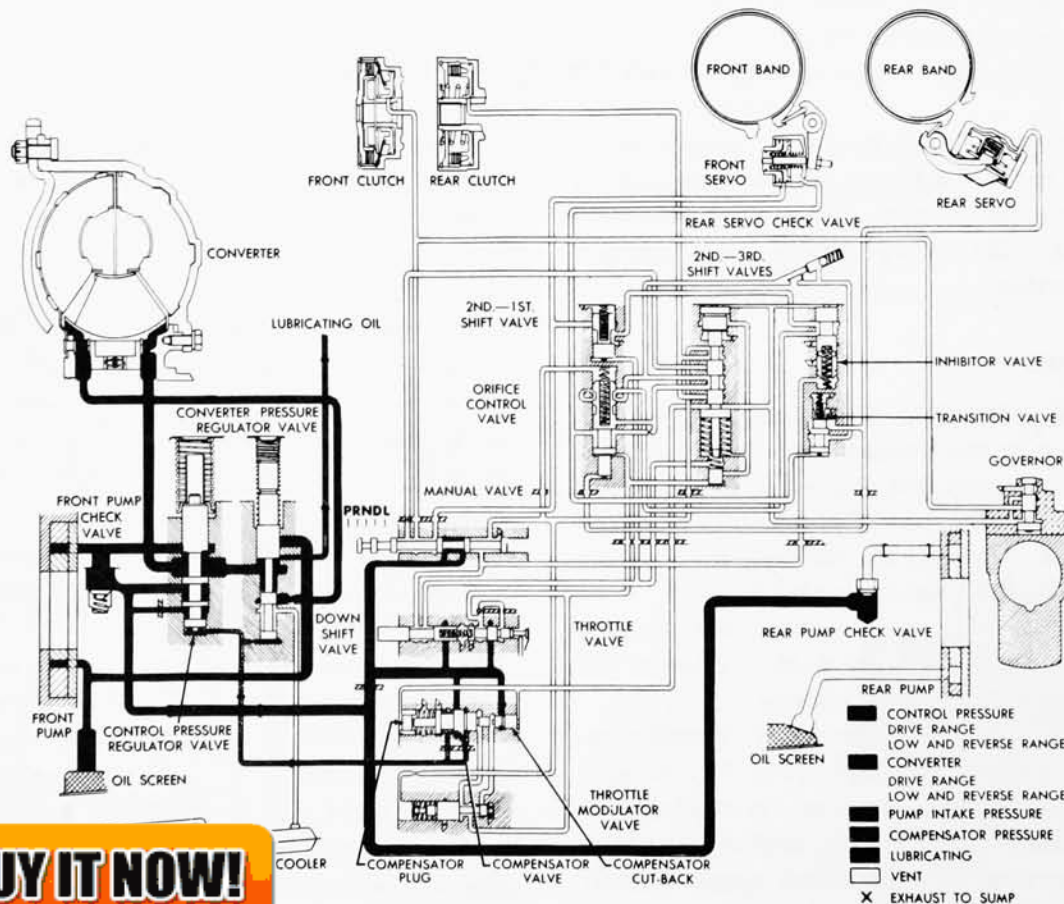

Fig. 16—Control Diagram—Neutral Ratio

**100% SATISFACTION GUARANTEED**

**BUY IT NOW!**

**Click Here To Order**

PayPal   American Express   Discover   MasterCard   VISA

driver depresses the accelerator to drive off, throttle pressure (or modulated pressure) acting on a face of the compensator valve assists compensator pressure against the compensator valve spring. This assistance reduces compensator pressure, and thereby increases control pressure. This is so, because control pressure is assisted, in all driving conditions (except reverse at and beyond  $9\frac{1}{2}^\circ$  to  $12^\circ$  throttle lever advance), by compensator pressure in opposition to the control pressure regulator valve spring.

Governor pressure which starts and increases with road speed, acts on the compensator plug (Fig. 17) and assists the compensator valve spring, which is opposing compensator pressure. Governor pressure, therefore, causes an increase in compensator pressure, and thereby a decrease in control pressure.

At approximately 30 m.p.h., governor pressure acting on the cut-back valve end face is high enough to overcome the control pressure force in the cut-back valve valley. Above approximately 30 m.p.h., therefore, governor pressure is acting at both ends of the compensator valve and the compensator pressure increase, which was caused by governor pressure acting on the compensator plug only, is "cut back."

For example, control pressure on a 6-cylinder vehicle

during a full-throttle acceleration from standing to 65 m.p.h. varies with road speed as follows:

Control pressure at the start (full-throttle) will be 124-144 p.s.i. Control pressure at about 30 m.p.h. will be 87-100 p.s.i. The decrease in pressure (from standing at full-throttle) is caused by governor pressure acting on the compensator plug only. Up to about 30 m.p.h., governor pressure force on the cut-back valve is locked out by control pressure acting on the cut-back valve.

At about 65 m.p.h. (full-throttle) control pressure will be 77-90 p.s.i. Although governor pressure is acting at both ends of the compensator valve above 30 m.p.h., the compensator plug diameter is slightly larger than the cut-back valve diameter. Therefore, an increase in governor pressure causes a slight increase in compensator pressure, with a consequent decrease in control pressure.

Above approximately 65 m.p.h. control pressure will not change with road speed, because governor pressure is maximum (equal to control pressure).

On other Fordomatic models, control pressure is higher, but follows the same general pattern.

(7) **CONVERTER PRESSURE.** Like control pressure, converter pressure is regulated by the converter pressure regulator valve spring and is adjusted to driving conditions by compensator pressure. Converter pressure range is approximately 15 p.s.i. to 60 p.s.i.

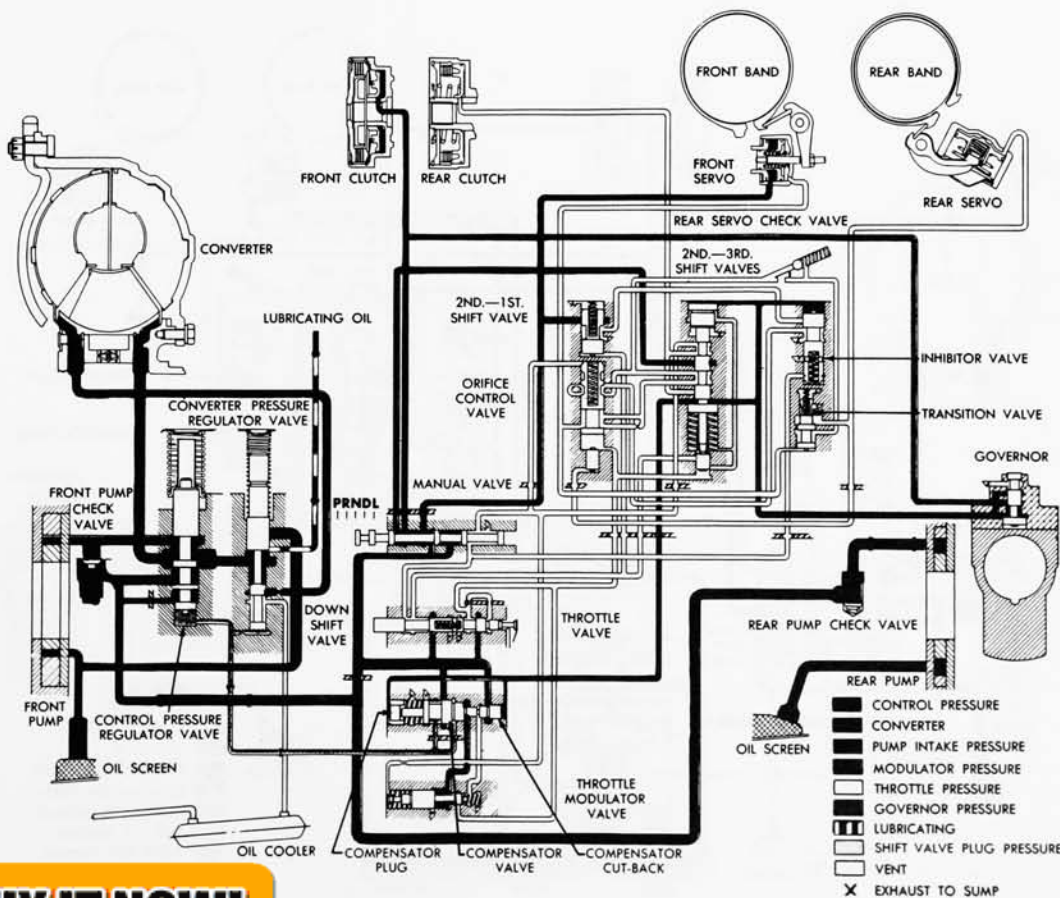

Fig. 17—Control Diagram—Intermediate Ratio

**100% SATISFACTION GUARANTEED**

**BUY IT NOW!**

**Click Here To Order**

PayPal   American Express   Discover   MasterCard   VISA

**b. Special Valves.**

Several valves in the control system have been designed to meet specific conditions in the transmission's operation.

(1) **ORIFICE CONTROL VALVE.** The orifice control valve is positioned in a bore in the control valve assembly by a spring. During a normal high to intermediate shift with closed throttle, smooth front band application is provided by exhausting the front servo release fluid through a small orifice. When the same shift occurs at open throttle, the orifice control valve, positioned by throttle pressure, permits an unrestricted exhaust of front servo release pressure, providing a rapid front band application.

On a manual shift from intermediate to low at closed throttle, the orifice control valve momentarily restricts the fluid flow applying the rear servo and releasing the front servo. This action provides a smooth rear band engagement.

(2) **DOWNSHIFT VALVE.** The downshift valve is positioned in the control valve body bore with the throttle valve. The inner throttle lever contacts one end of the downshift valve and the inner end contacts the downshift valve spring. Control pressure is directed to a land of the valve. Linkage is connected between the

accelerator pedal and throttle lever. The downshift valve is moved to open a passage to direct fluid pressure to the back face of the 2-3 shift valve and the 2-1 shift valve, when the accelerator pedal is depressed through the detent.

(3) **TRANSITION VALVE.** The transition valve is positioned in a bore in the control valve body by a spring. The function of this valve is to time the operation of the front servo in relation to the rear servo.

Fluid flow to apply the rear band is blocked by the transition valve until the flow to release the front band has built up enough pressure to open the transition valve against its spring.

When the rear band is released, the fluid is exhausted slowly by the action of the rear servo check valve orifice until front servo release pressure is exhausted. With front servo release pressure gone, the transition valve is moved by its spring and provides an unrestricted exhaust for the rear servo fluid.

(4) **LOW INHIBITOR VALVE.** The low inhibitor valve is a part of the control valve assembly. This valve prevents a shift into low above approximately 25 m.p.h.

A spring at one end of the valve holds it in a closed position. Passages are provided at both ends of the valve. Governor pressure is directed to the end of the

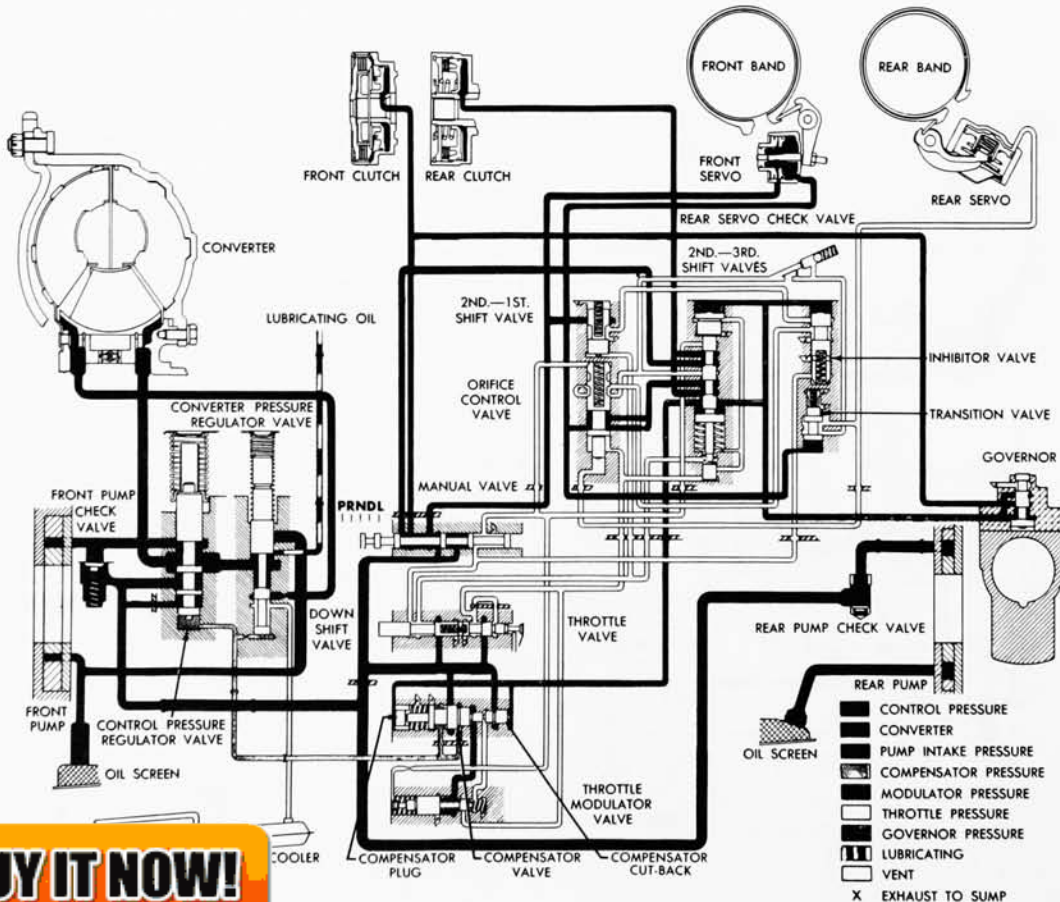

Fig. 18—Control Diagram—High Ratio

**100% SATISFACTION GUARANTEED**

**BUY IT NOW!**

**Click Here To Order**

PayPal, American Express, Discover, MasterCard, VISA

valve opposite the spring, and fluid pressure from the manual valve is directed to one of the lands. The valve is moved against the spring when the vehicle speed increases to produce enough governor pressure to overcome the spring force, and causes the shift from low to intermediate.

**c. Operation.**

The automatic operation of the transmission is provided by controlling the flow of fluid pressure to the components. Fluid flow needed to operate the components and to provide the different ratios is explained here. Control diagrams for all the ratios are given on the following pages.

(1) **NEUTRAL RANGE (Fig. 16).** With the engine running, the front pump is delivering fluid to the control pressure regulator, manual, downshift, throttle, compensator and compensator cut-back valves.

The manual valve in N (neutral) position blocks the fluid flow to both clutches and both bands. With no fluid pressure in the clutches or servos, both clutches and bands are released by spring pressure and drive through the transmission is impossible.

The front pump is delivering more fluid than is necessary to maintain control pressure; hence, the control

pressure regulator valve (assisted by compensator pressure) has moved against its spring and is delivering fluid to the converter input passage.

The converter has been filled and is at normal pressure. Therefore, the converter pressure regulator valve has moved against its spring and has opened a passage for fluid to flow to the transmission lubrication system.

(2) **DRIVE RANGE—INTERMEDIATE RATIO. (Fig. 17).** When the selector lever is moved from the N (neutral) position to Dr (drive), the manual valve moves to open passages from the manual valve to the front clutch and governor, the apply side of the front servo, and to the 2-1 and 2-3 shift valves. Control pressure to the front clutch locks the primary sun gear to the turbine shaft. Control pressure to the apply side of the front servo applies the front band to hold the secondary sun gear. The 2-1 and 2-3 shift valves are held in the closed position by the shift valve springs, and control pressure is blocked at the shift valve lands. With the primary sun gear driven and the secondary sun gear held, the transmission operates in the intermediate ratio of 1.47 to 1.

(3) **DRIVE RANGE—HIGH RATIO (Fig. 18).** The shift from the intermediate to the high ratio is accomplished when the front servo is released and the rear

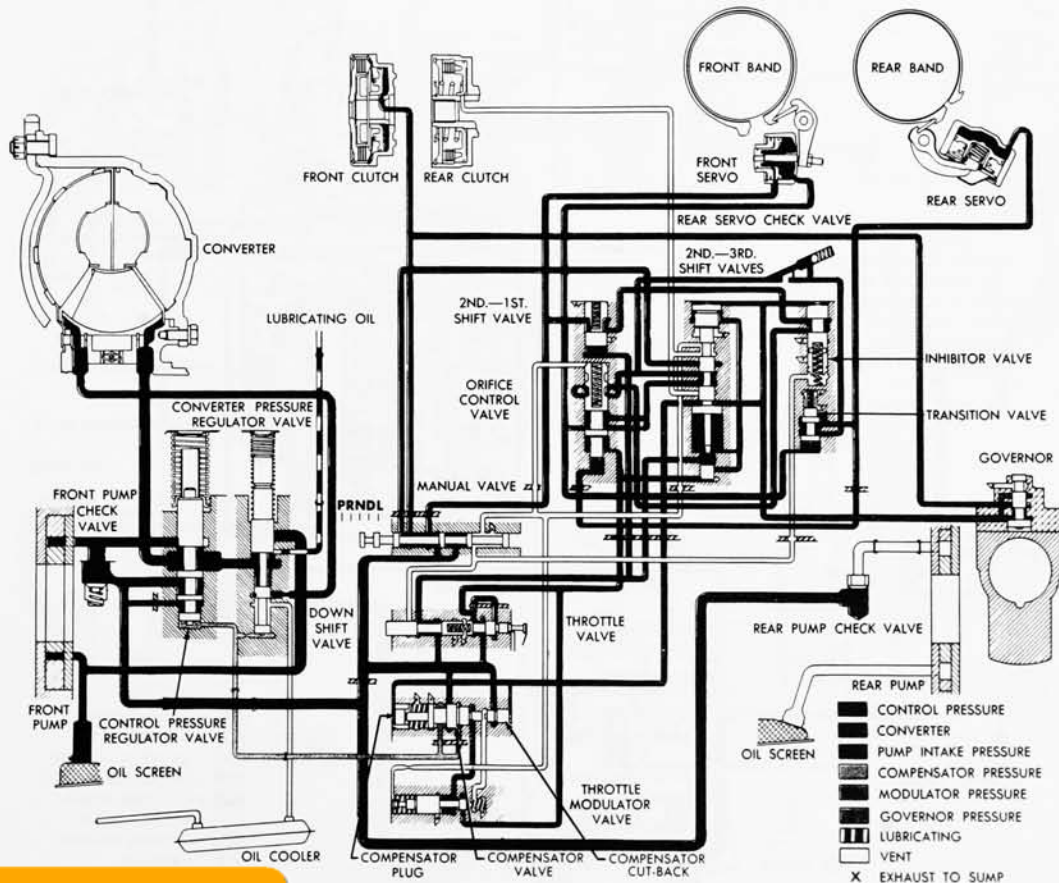

—Control Diagram—Low Ratio (Selector in Dr)

5595

**100% GUARANTEED**

**BUY IT NOW!**

**Click Here To Order**

PayPal   American Express   Discover   MasterCard   VISA

clutch is applied. This is accomplished by directing governor pressure to a face of the 2-3 shift valve and to the governor plug. As the shift valve moves inward, passages are uncovered to direct control pressure to the release side of the front servo and to the rear clutch. When both clutches are applied, the primary and secondary sun gears are locked to the turbine shaft to provide the high ratio of 1 to 1.

A centrifugally-operated governor is used to provide automatic shifts from the intermediate to the high ratio. Control pressure from the manual valve is directed against a face of the governor valve. The governor valve is forced outward by centrifugal force as the output shaft begins to rotate. Control pressure is reduced and is regulated in direct proportion to the vehicle speed. When enough governor pressure is provided against the shift valve to overcome the springs, the shift valve moves inward to uncover the passages to the release side of the front servo and to the rear clutch.

**(4) DRIVE RANGE—LOW RATIO (Fig. 19).** When the accelerator pedal is depressed beyond the detent (forced down-shift) below 16 m.p.h. the down-shift valve directs control pressure to close the 2-3 shift valve and open the 2-1 valve.

At the same time, control pressure starts to flow

through the 2-1 valve to apply the rear band and release the front band. With the front clutch applied, the front band released, and the rear band applied, the transmission is in the low ratio.

Forced downshifts to the low ratio above 16 m.p.h. are prevented by the 1-2 (inhibitor) valve, which is closed by governor pressure at this speed in high and intermediate ratios.

Upshifts from the drive range—low ratio are accomplished automatically. Governor pressure against the end of the low inhibitor valve increases with vehicle speed. At approximately 28-34 m.p.h., governor pressure is high enough to move the low inhibitor valve inward to cut off rear servo apply and front servo release pressure. The front band is then applied by front servo apply pressure, and the transmission shifts from the low to the intermediate ratio.

**(5) LOW RANGE (Fig. 20).** In the Lo (low) range, control pressure is directed to the front clutch and governor, to the apply side of the front servo and to the 2-1 shift valve, and through the downshift valve to the ends of the shift valves. Control pressure directed to the end of the 2-1 shift valve moves it against spring pressure. A passage is opened from the 2-1 shift valve, through the closed 2-3 shift valve, and orifice control

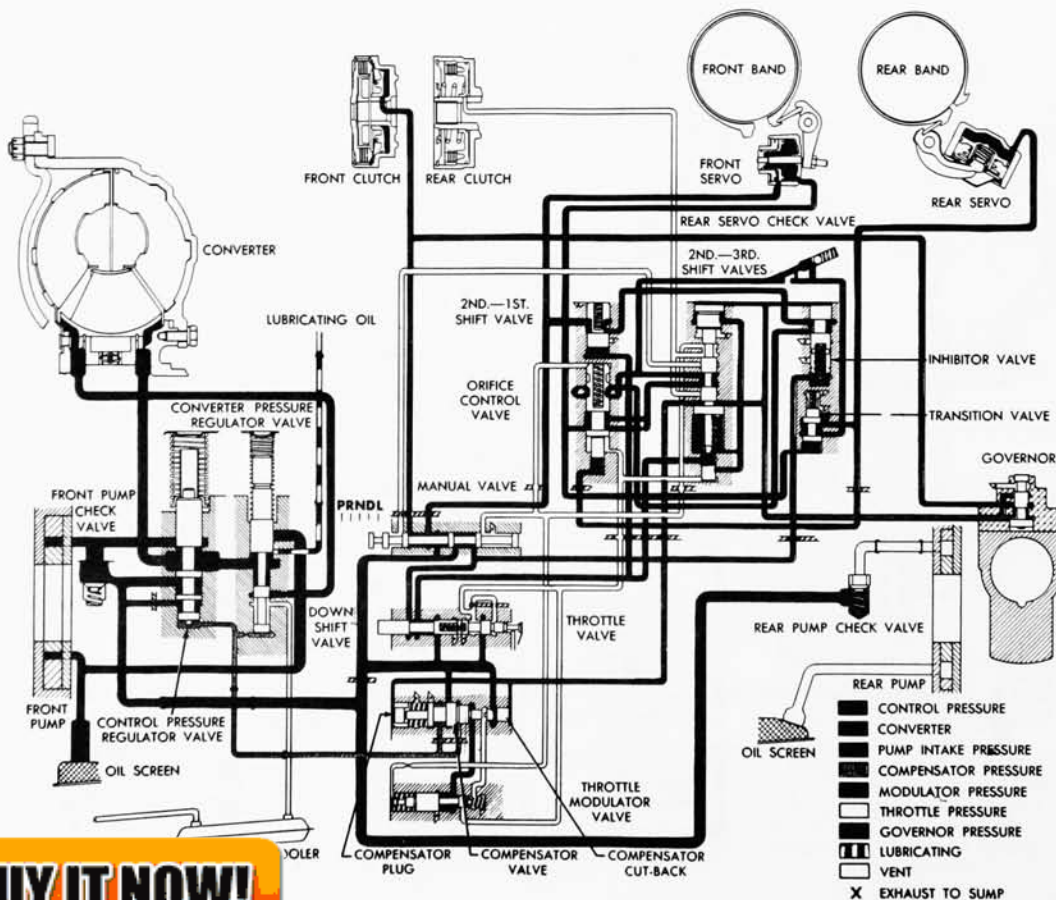

—Control Diagram—Low Ratio (Selector in Lo)

**100% SATISFACTION GUARANTEED**

**BUY IT NOW!**

**Click Here To Order**

PayPal American Express Discover Novus MasterCard VISA

valve to the release side of the front servo. At the same time, control pressure is directed to the rear servo to apply the band.

Upshifts from the low range are prevented by control pressure, from the manual valve, directed to the spring end of the low inhibitor valve. Governor pressure on the end of the valve is insufficient to move the valve against opposing control pressure. As long as front band release and rear clutch apply pressures are present, upshifts are prevented.

(6) **REVERSE RANGE (Fig. 21).** Control pressure to the front clutch is cut off at the manual valve. Control pressure from the manual valve is directed to the apply side of the front servo, and through the 2-1 shift valve, 2-3 shift valve and orifice control valve to the release side of the front servo and to apply the rear servo. Control pressure from the manual valve is also directed to the rear clutch. With the rear band and rear clutch applied, the transmission operates in the reverse ratio of 2 to 1.

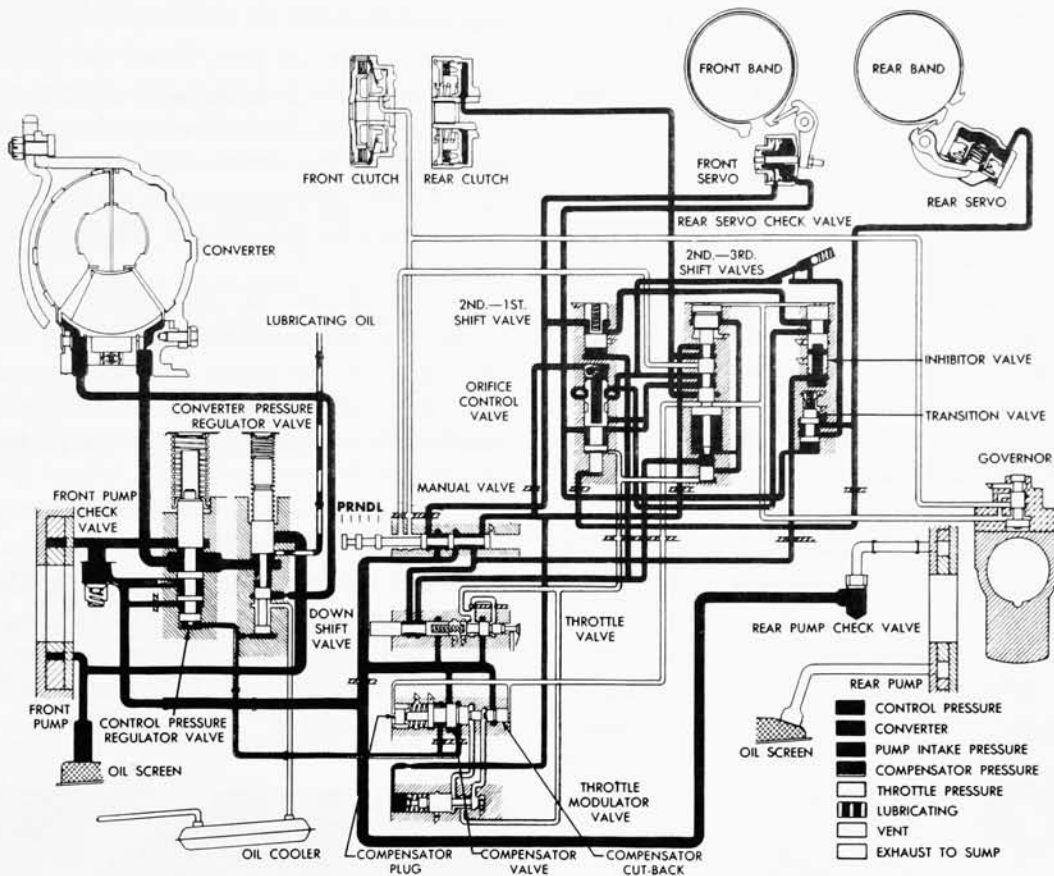

5597

Fig. 21—Control Diagram—Reverse Ratio

**100% SATISFACTION GUARANTEED**

**BUY IT NOW!**

**Click Here To Order**

PayPal   American Express   Discover   MasterCard   VISA



**BUY IT NOW!**

**Click Here To Order**



PayPal

Discover  
Cards

DISCOVER  
NEWUS

MasterCard

VISA